

**Ducted Split System
Air Conditioner**

Technical Data
ISD 200K / OSA 200RKTH

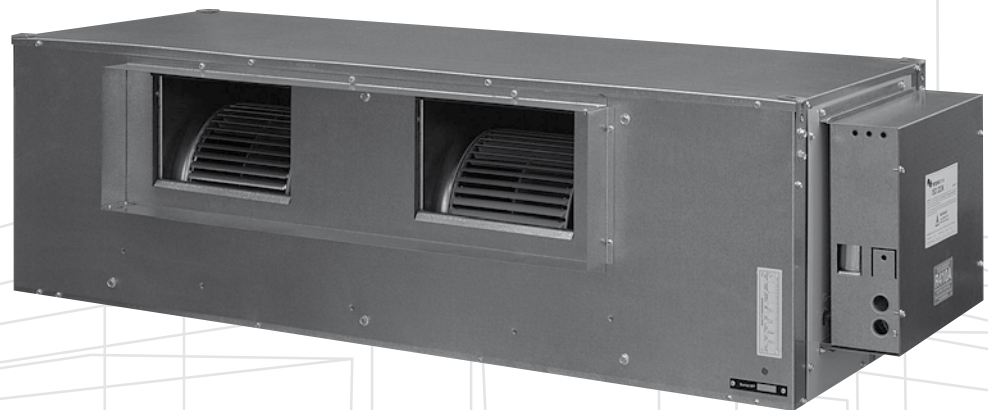

R410A



**Optional
SAT Controller**

Extra Long Life
Epoxy Coated Outdoor Coil

Nominal Cooling Capacity
19.3 kW

ISD 200K / OSA 200RKTH DUCTED SPLIT SYSTEM AIR CONDITIONER

GENERAL

The ISD indoor unit, together with its associated OSA outdoor unit, provides a reverse cycle (heat pump) split system air conditioner designed and developed to comply with AS/NZS 3823 specified conditions. The system has been tested and proven for cooling operation in outdoor temperatures up to 50°C.

APPLICATIONS

These units have been specifically developed for air conditioning of light commercial and residential premises, e.g. offices, motels, shops and homes.

Air Flow Selection

If the air returning to the indoor coil is regularly expected to be above 50%RH, then the coil face velocity should be limited to be 2.5 m/s or less (refer Air Flow graph; 2.5 m/s is clearly marked).

High humidity levels can occur in tropical or subtropical conditions, and/or when heavily moisture laden fresh air is introduced. Consideration must always be given to selecting an air flow and face velocity that avoids water carry-over problems.

Applications using full or high proportions of fresh air should be referred to your nearest **temperzone** sales office to establish the correct selection of units.

FEATURES

Refrigerant R410A. Each complete system uses refrigerant R410A which is deemed to have zero ozone depletion potential.

Efficient. The outdoor unit incorporates a high efficiency scroll compressor. Heat exchange coils incorporate inner grooved (rifled) tube for better heat transfer.

Performance. A dynamically balanced forward curved fan with a multi-speed motor enables fine tuning of the indoor unit to match the supply air requirements. The system includes a temperature sensing head pressure control which enables the system to compensate for outdoor ambient temperatures below 20°C on cooling cycle, and above 15°C on heating cycle.

Quiet. The compressor is isolated in a built-in, insulated compartment to minimise noise. The indoor unit is also insulated for noise attenuation.

Slimline. The compact up-right design of the outdoor unit requires only a 150 mm gap on the coil side where installation is against a wall. Its slimline cabinet is particularly practical where there is restricted space, e.g. side access pathways, balconies, narrow ledges, etc. Vertical discharge grilles are available to deflect prevailing winds and reduce clearances. The unit is free standing, but can be fitted on a wall using the optional wall mounting brackets.

Durable. The outdoor coil fins are epoxy coated for extra protection in corrosive environments, e.g. salt laden sea air. The outdoor unit's cabinet is constructed from high grade galvanised steel - polyester powder coated (grey) for all weather protection (IP 45). External fasteners are stainless steel. Heat exchange coils comprise aluminium plate fins on mechanically expanded rifled copper tube. The indoor unit's cabinet is constructed from high grade galvanised steel and also includes a plastic drain tray for complete corrosion resistance.

Service Access. The indoor unit's built-in drain tray can be removed for ease of cleaning and service accessibility.

Insulation. Closed cell foam insulation has been used in the indoor unit's cabinet to ensure no particles are introduced into the air stream. The insulation is foil faced and meets fire test standards AS 1530.3 (1989) and BS 476 parts 6 & 7.

Mounting. The indoor unit can be mounted rigid, or using the optional spring mounting brackets which minimise transfer of vibration.

Self Diagnostics. The Outdoor Unit Controller (OUC) has a display of LEDs to indicate faults and running conditions. A non-specific fault indicator is included for interface to external systems via the optional auxillary relay board.

OPTIONAL EQUIPMENT

Outdoor Unit:

1. Fault indicating auxillary relay board.
2. Vertical discharge grille (2 required).
3. Anti-vibration mounts (rubber)
4. Drain connection - right angle

Indoor Unit:

1. Filter box - integrated return air spigot and washable polypropylene net filter.

2. **temperzone** SAT Controller.
3. Spring Mounting Kit.
4. 4.5 kW electric booster heater box - complete with safety cutouts required to meet AS/NZS 3350.2.40 1997.
5. Supply and return air plenums.
6. Safety drain tray.

SAFETY FEATURES

1. HP and loss of refrigerant protection.
2. Anti-rapid cycle timer and internal overload for compressor protection.
3. Circuit breaker control circuits.
4. Time-and-temperature controlled electronic de-ice switch prevents icing up of the outdoor coil during heating cycle.
5. Frost protection on cooling cycle.
6. Sensor fault indication.
7. Compressor minimum run time to ensure oil return.

COMPRESSOR

Each high efficiency scroll type compressor is hermetically sealed, quiet running and supported on rubber mounts to minimise vibration.

REFRIGERATION PIPING

The standard unit allows for a line length up to 30 m. For line lengths between 30 m and 60 m, refer to **temperzone's Split Systems Installation Guide** (refer www.temperzone.biz/Technical/Support).

Maximum line length when extended is 60m.

Max. height separations between units are :
Outdoor unit above indoor unit : 20 m
Outdoor unit below indoor unit : 20 m.

The OSA 200 is shipped from the factory with a charge of HFC-410A (R410A) refrigerant sufficient for a 10 m line length. Liquid and suction service valves are provided. Accurator expansion devices control the flow of refrigerant. The matched indoor unit is shipped with a holding charge of nitrogen. Both units have brazed pipe connections.

WIRING

The electrical supply required (including voltage fluctuation limits) is: 3 phase 342-436 V a.c. 50 Hz with neutral and earth. The compressor crankcase heater requires a 24 hour power supply. A control panel, located in the outdoor unit, is fully wired ready to accept the main power supply.

AIR HANDLING

Note: Airflows are for a dry coil. Reduce airflow by 5% in high moisture removal conditions. In a free blow application, beware of exceeding indoor fan motor's full load amp limit.

As filters are optional, the fan air flows given are for units installed without filters.

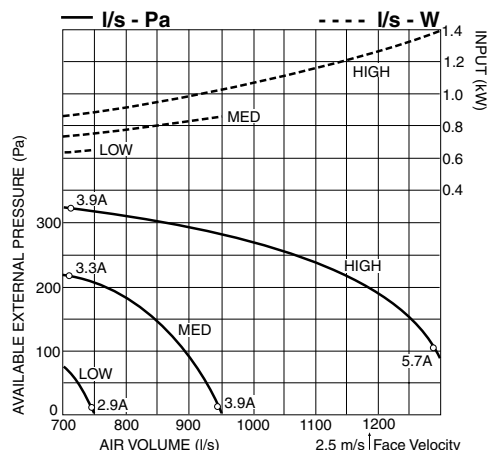

ELECTRICAL

E.E.R. (cooling)	2.94
Indoor Fan Full Load Amps	7 A
Running Amps (Total System)	14 / 9 / 8
Recommended External Fuse	25 A

Optional Polypropylene Net Filter Media (clean):

Coil Face Velocity (m/s)	1.5	2.0	2.5
Pressure Loss (Pa)	5	9	13

The manufacturer operates a quality management system that conforms to AS/NZS ISO 9001:2000.

PERFORMANCE DATA

COOLING CAPACITY (kW)

Total = Total Capacity (kW)

Sens. = Sensible Capacity (kW)

E.A.T. = Entering Air Temperature

○ = Nominal Capacity (kW)

Note: Capacities are **gross** and do not include allowance for fan motor heat loss. Capacities are for close coupled systems. Interconnecting pipework will reduce capacity.

MODELS Indoor / Outdoor Unit	INDOOR FAN		INDOOR COIL E.A.T.		OUTDOOR COIL ENTERING AIR TEMPERATURE °C D.B.											
	SPEED	AIR l/s	W.B. °C	D.B. °C	23		27		31		35		39		43	
					Total	Sens.	Total	Sens.	Total	Sens.	Total	Sens.	Total	Sens.	Total	Sens.
ISD 200K / OSA 200RK	HIGH	1050	15	21	18.9	15.0	18.7	15.0	18.2	14.7	17.3	14.2	16.2	13.4	14.7	12.4
			17	23	20.0	14.6	19.7	14.6	19.2	14.4	18.3	13.9	17.2	13.2	15.8	12.3
			19	27	21.0	16.8	20.7	16.8	20.2	16.5	19.3	16.0	18.2	15.3	16.8	14.2
			21	31	22.0	19.9	21.7	19.9	21.2	19.6	20.3	19.1	19.2	18.2	17.8	17.1

Indoor Air Flow Correction Factors @ nominal conditions

	Indoor Air Flow (%)			
	-20%	-10%	Rated	+10%
Total Capacity	0.95	0.975	1.0	1.025
Sensible Capacity	0.89	0.950	1.0	1.050

PIPE LENGTH CAPACITY LOSS

ON COOLING CYCLE DUE TO PRESSURE DROP

Note: Loss percentage is approximate only.

No allowance made for vertical piping.

Pipe Size (mm)		Equivalent Line Pipe Length (m)					Additional Pipe Length to allow per Bend	
Liquid	Suction	5	10	15	20	30	Suction Pipe Size OD	22 mm
13	22	0.7 %	2.1 %	3.4 %	4.7 %	6.1 %	Long 90° Radius (2 x pipe dia.)	0.5 m

HEATING CAPACITY (kW)

G = Gross Heating Capacity kW, based on nominal air flow of 1000 l/s.

N = Net Heating Capacity kW allowing for average defrost.

○ = Nominal Capacity (kW)

MODELS Indoor / Outdoor Unit	INDOOR ENTERING AIR TEMP. °C D.B.	OUTDOOR COIL ENTERING AIR TEMPERATURE (E.A.T.) °C D.B.															
		-5		-3		-1		1		3		5		7		9	
		G	N	G	N	G	N	G	N	G	N	G	N	G	N	G	N
ISD 200K / OSA 200RK	15	11.8	10.7	12.8	11.5	13.7	12.3	14.6	12.8	15.5	13.1	16.6	15.0	17.7	17.5	18.6	18.6
	20	11.6	10.5	12.6	11.3	13.4	12.1	14.3	12.6	15.2	12.8	16.3	14.7	17.3	17.2	18.2	18.2
	25	11.2	10.1	12.1	10.9	12.9	11.6	13.8	12.1	14.6	12.3	15.7	14.1	16.7	16.5	17.5	17.5

SOUND LEVELS

Sound Power Levels (SWL)

Test Conditions: BS 848 PT2 1985. Installation Type A (free inlet and outlet). Direct method of measurement (reverberant room).

Measured in decibels re 1 picowatt.

Indoor Unit - Supply Air Outlet

FAN SPEED	AIR FLOW l/s	SWL dB(A)	OCTAVE BAND FREQUENCY Hz					
			125	250	500	1 k	2 k	4 k
			SOUND POWER LEVELS (SWL) dB					
LOW	700	63	57	58	62	58	58	52
MED	900	69	63	63	66	64	64	59
HIGH	1050	76	70	70	71	72	72	67

Outdoor Unit

MODEL	FAN SPEED	SWL dB(A)	OCTAVE BAND FREQ. Hz						SPL @ 3 m dB(A)	OCTAVE BAND FREQ. Hz					
			125	250	500	1 k	2 k	4 k		125	250	500	1 k	2 k	4 k
			SOUND POWER LEVELS dB							SOUND PRESSURE LEVELS dB					
OSA 200	LOW	70	74	71	68	66	60	53	54	58	55	52	50	44	37
	MED	71	76	71	69	67	61	54	55	60	55	53	51	45	38

Sound Pressure Level (SPL) in decibels re 20 µPa.

DIMENSIONS (mm)

Not to Scale

ISD 200K Indoor Unit

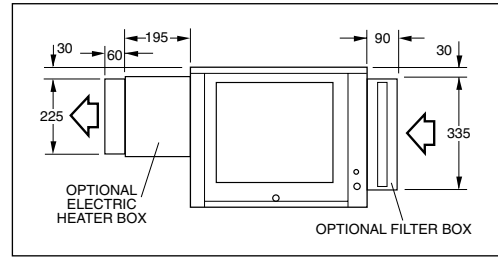
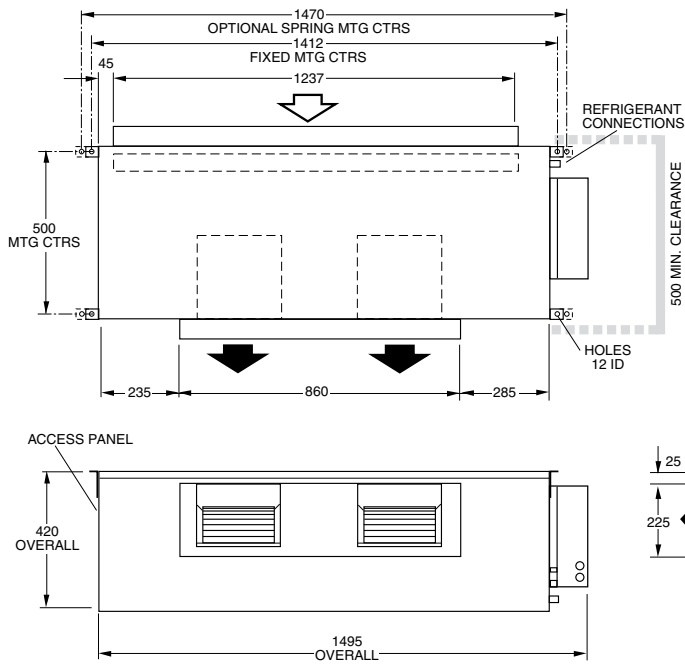

Net Weight 61 kg
Shipping Weight 72 kg

FAN ACCESS VIA REMOVEABLE BASE & DRAIN TRAY

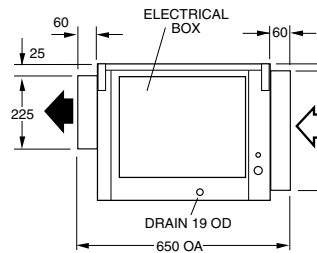

OSA 200RKT Outdoor Unit

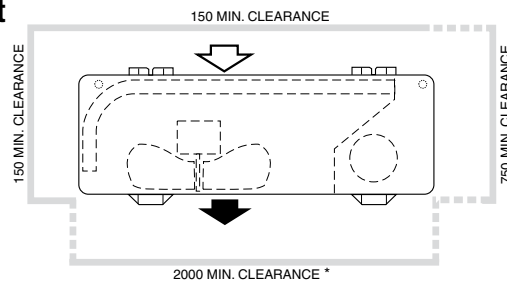

Note

Materials and specifications are subject to change without notice due to the manufacturer's ongoing research and development programme.

Net Weight 137 kg
Shipping Weight 155 kg

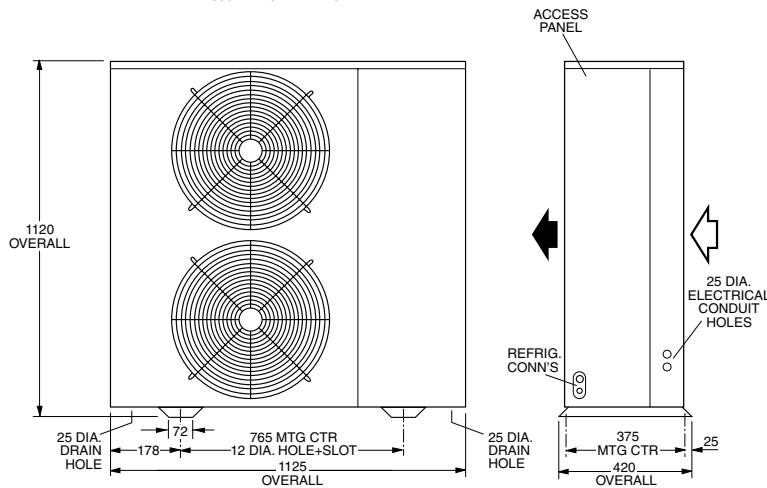

Recommended Pipe Line Sizes

Liquid: 13 mm OD
Suction: 22 mm OD

* 600 min with optional Vertical Discharge Grilles

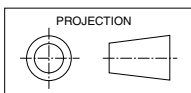

temperzone limited

Head Office, Auckland : 38 Tidal Rd, Mangere, N.Z.
Private Bag 93303, Otahuhu, NEW ZEALAND.
Email sales@temperzone.co.nz Website: www.temperzone.biz

temperzone australia pty ltd

Head Office, Sydney : 7A Bessemer St
PO Box 6448, Delivery Centre, Blacktown, NSW 2148,
AUSTRALIA. Email sales@temperzone.com.au

AUCKLAND

Ph. 0-9-279 5250
Fax 0-9-275 5637

WELLINGTON

Ph. 0-4-569 3262
Fax 0-4-566 6249

CHRISTCHURCH

Ph. 0-3-379 3216
Fax 0-3-379 5956

SYDNEY

Ph. (02) 8822-5700
Fax (02) 8822-5711

ADELAIDE

Ph. (08) 8376-1505
Fax (08) 8376-1449

SINGAPORE

Ph. SNG 6733 4292
Fax SNG 6235 7180

MELBOURNE

Ph. (03) 9551-7422
Fax (03) 9551-8550

BRISBANE

Ph. (07) 3399-2544
Fax (07) 3399-2577

NEWCASTLE

Ph. (02) 4962-1155
Fax (02) 4961-5101



PERTH

Ph. (08) 9314-3844
Fax (08) 9314-3855

TOWNSVILLE

Ph. (07) 4773-9566
Fax (07) 4773-9166

HOBART

Ph. (03) 6272-0066
Fax (03) 6272-0506

Available from