

HITACHI

# OPERATION INSTALLATION & MAINTENANCE MANUAL

**air**Core 700  
SINGLE SPLIT  
INVERTER SERIES  
**INDOOR UNITS**



## MODELS

### CEILING SUSPENDED TYPE

PPFC-2.0UFA1NQ

PPFC-2.5UFA1NQ

PPFC-3.0UFA1NQ

PPFC-4.0UFA1NQ

PPFC-5.0UFA1NQ

PPFC-6.0UFA1NQ



EN INSTRUCTION MANUAL

Scan the code to get the electronic manual.

Cooling & Heating

P02132Q

air

# IMPORTANT NOTICE

- Hitachi pursues a policy of continuous improvement in design and performance of products. The right is therefore reserved to vary specifications without notice.
- Hitachi cannot anticipate every possible circumstance that might involve a potential hazard.
- This heat pump air conditioner is designed for human comfort air conditioning only. Do not use this heat pump air conditioner for other purposes such as drying clothes, refrigerating foods or for any other cooling or heating purposes.
- The installer and system specialist shall ensure safety against leakage according to local regulations or standards. The following standards may be applicable if local regulations are not available. British Standard, BS4434 or Japan Standard, KHK0010.
- No part of this manual may be reproduced without written permission.
- This manual should be considered as a permanent part of the air conditioning equipment and should remain with the air conditioning equipment.
- Signal words (DANGER, WARNING, CAUTION and NOTE) are used to identify levels of hazard seriousness. Definitions for identifying hazard levels are provided below with their respective signal words.



**DANGER** : **DANGER** indicates a hazardous situation which, if not avoided, will result in death or serious injury.



**WARNING** : **WARNING** indicates a hazardous situation that, if not avoided, could result in death or serious injury.



**CAUTION** : **CAUTION** indicates a hazardous situation which, if not avoided, could result in minor or moderate injury.

**NOTE** : **NOTE** is useful information for operation and/or maintenance.

- It is assumed that this heat pump air conditioner will be operated and serviced by persons conversant in English. If this is not the case, the distributor should add safety, caution and operating signs in the native language.
- If you have any questions, contact your distributor or dealer of Hitachi.
- This unit shall be installed in accordance with local codes and regulations.
- Do not install the unit in the following places. It may cause a fire, deformation, corrosion or failure.
  - Places where oil (including machinery oil) may be present in quantities.
  - Places where a lot of sulfide gas drifts such as in a hot spring.
  - Places where inflammable gas may generate or flow.
  - Places where strong salty wind blows such as coast regions.
  - Places with an atmosphere of acidity or alkalinity.
- This manual gives a common description and information for this heat pump air conditioner which you operate as well for other models.
- This system has been designed and tested to operate within the indoor temperature limits as stated below. The manufacturer cannot guarantee satisfactory performance if the unit is operated for prolonged periods outside of these limits.

	(°C)	
Temperature Range	Maximum	Minimum
Cooling Operation	32 DB / 23 WB	21 DB / 15 WB
Heating Operation	27 DB	20 DB

DB: Dry Bulb WB: Wet Bulb



## Correct Disposal of this product

This marking indicates that this product should not be disposed with other household wastes. To prevent possible harm to environment or human health from uncontrolled waste disposal, recycle it responsibly to promote the sustainable reuse of material resources. To return your used device, please use the return and collection systems or contact the retailer where the product was purchased. They can take this product for environmental safe recycling.

## DANGER

- Do not install pipe work with diameters that are not specified for that model.
- Do not ground units to water pipes, gas pipes, telephone wires, or lightning rods as incomplete grounding can cause a severe shock hazard resulting in severe injury or death. Additionally, grounding to gas pipes could cause a gas leak and potential explosion causing severe injury or death.
- Do not install unit in an area where flammable materials are present due to risk of explosions that can cause serious injury or death.
- Safely dispose all packing and transportation materials in accordance with federal/state/local laws or ordinances. Packing materials such as nails and other metal or wood parts, including plastic packing materials used for transportation may cause injuries or death by suffocation.
- Refrigerant gas is heavier than air and replaces oxygen. A massive leak can lead to oxygen depletion, especially in basements, and an asphyxiation hazard could occur leading to serious injury or death.
- If refrigerant gas leaks during installation, ventilate the area immediately. Refrigerant gas may produce toxic gas if it comes into contact with fire. Exposure to this gas could cause severe injury or death.

## WARNING

- Assure that the maximum operating pressure is checked when connecting to Outdoor UNIT.
- This unit <PPFC-UFA1NQ> is a PARTIAL UNIT AIR CONDITIONER, shall only be connected to an appliance suitable for the same refrigerant.
- This unit <PPFC-UFA1NQ> is a PARTIAL UNIT AIR CONDITIONER, complying with PARTIAL UNIT requirements of IEC 60335-1 and IEC 60335-2-40, and must only be connected to other units that have been confirmed as complying to corresponding PARTIAL UNIT requirements of IEC 60335-1 and IEC 60335-2-40.
- Only qualified personnel licensed or certified in their jurisdiction must carry out the installation work. Installation must be done in accordance with this installation manual. Improper installation may result in water leakage, electric shock, or fire.
- Pipe work and installation shall be in compliance with national codes (ASHRAE15 or IRC).
- Use only specified accessories and parts for installation work. Failure to use specified parts may result in water leakage, electric shock, fire, or the unit falling.
- Install the air conditioner or heat pump on a foundation strong enough that it can withstand the weight of the unit. A foundation of insufficient strength may result in the unit falling and causing injuries.
- Take into account strong winds, typhoons, or earthquakes when installing. Improper installation may result in the unit falling and causing accidents.
- Make sure that a separate power supply circuit is provided for this unit and that all electrical work is carried out by qualified personnel licensed or certified in their jurisdiction according to local, state, and national regulations. An insufficient power supply capacity or improper electrical construction may lead to electric shock or fire.
- Make sure that all wiring is secured, that specified wires are used, and that no external forces act on the terminal connections or wires. Improper connections or installation may result in fire.
- When wiring, position the wires so that the electrical wiring box cover can be securely fastened. Improper positioning of the electrical wiring box cover may result in electric shock, fire, or the terminals overheating.
- Before touching electrical parts, turn off the unit.
- The circuit must be protected with safety devices in accordance with local and national codes, i.e. a circuit breaker.
- Securely fasten the outdoor unit terminal cover (panel). If the terminal cover/panel is not installed properly, dust or water may enter the outdoor unit causing fire or electric shock.
- When a fire occurs, cut off the power supply immediately.

## CAUTION

- Do not touch the switch with wet fingers. Touching a switch with wet fingers can cause electric shock.
- This appliance can be used by children aged from 8 years and above and persons with reduced physical, sensory or mental capabilities or lack of experience and knowledge if they have been given





supervision or instruction concerning use of the appliance in a safe way and understand the hazards involved. Cleaning and user maintenance shall not be made by children without supervision.

- Wear adequate personal protective equipment (protective gloves, safety glasses,...) when installing, maintaining or servicing the system.
- The heat exchanger fins are sharp enough to cut. To avoid injury, wear gloves or cover the fins while working around them.
- Do not touch the refrigerant pipes during and immediately after operation as the refrigerant pipes may be hot or cold, depending on the condition of the refrigerant flowing through the refrigerant piping, compressor, and other refrigerant cycle parts. Your hands may suffer burns or frostbite if you touch the refrigerant pipes. To avoid injury, give the pipes time to return to normal temperature or, if you must touch them, be sure to wear proper gloves.
- Install drain piping to ensure proper drainage. Improper drain piping may result in water leakage and property damage.
- Insulate piping to prevent condensation.
- Be careful when transporting the product.
- Do not install the air conditioner or heat pump in the following locations:
  - Where a mineral oil mist or oil spray or vapor is produced, for example, in a kitchen. Plastic parts may deteriorate and fall off or result in water leakage.
  - Where corrosive gas, such as sulfuric acid gas, is produced. Corroding copper pipes or soldered parts may result in refrigerant leakage.
  - Near machinery emitting electromagnetic waves. Electromagnetic waves may disturb the operation of the control system and cause the unit to malfunction.
  - Where flammable gas may leak, where there is carbon fiber, or ignitable dust suspension in the air, or where volatile flammables such as thinner or gasoline are handled. Operating the unit in such conditions can cause a fire.
- Take adequate measures to prevent the outdoor unit from being used as a shelter by small animals. Small animals making contact with electrical parts can cause malfunctions, smoke, or fire. Instruct the user to keep the area around the unit clean.
- This appliance is not intended for use by persons (including children) with reduced physical, sensory or mental capabilities, or lack of experience and knowledge, unless they have been given supervision or instruction concerning use of the appliance by a person responsible for their safety. Children should be supervised to ensure that they do not play with the appliance.

**NOTES:**

- The air in the room should be renewed and the room ventilated every 3 or 4 hours.
- The indoor unit should be positioned where the unit and interunit wires (outdoor to indoor) are at least 3.3ft (1m) away from any televisions or radios. (The unit may cause interference with the picture or sound.) Depending on the radio waves, a distance of 3.3ft (1m) may not be sufficient to eliminate the noise.
- Dismantling the unit, treatment of the refrigerant, oil and additional parts must be done in accordance with the relevant local, state, and national regulations.
- As maximum allowable pressure is 4.15MPa, minimum allowable pressure is 2.21MPa, the wall thickness of field-installed pipes should be selected in accordance with the relevant local, state, and national regulations.

**Explanation of symbols displayed on the indoor unit or outdoor unit**

	<b>WARNING</b>	These symbols show that appliance uses a flammable refrigerant. If the refrigerant is leaked and exposed to an external ignition source, there is a risk of fire.
		
	<b>CAUTION</b>	This symbol shows that the operation manual should be read carefully.
	<b>CAUTION</b>	This symbol shows that a service personnel should be handling this equipment with reference to the installation manual.
	<b>CAUTION</b>	This symbol shows that information is available such as the operating manual or installation manual.

## Precuations for R32

**This air conditioner uses R32 flammable refrigerant.** Air conditioner with R32 refrigerant, if not be treated carefully, may cause serious harm to the human body or surrounding things. Please read the following instructions carefully before installing, using and maintaining.

### WARNING

- Do not use means to accelerate the defrosting process or to clean, other than those recommended by the manufacturer.
- The appliance shall be stored in a room without continuously operating ignition sources (for example: open flames, an operating gas appliance or an operating electric heater).
- Do not pierce or burn the refrigerant system to avoid the leakage.
- Be aware that refrigerants might not contain an odour.
- Do not charge R32 into system other than those designated for R32.  
Do not charge R32 system with oil other than those designated for R32.
- Do not use a reclaim cylinder other than an R32 reclaim cylinder.
- Be sure to only use refrigerant piping approved for use with R32 refrigerant. The use of unapproved piping may result in explosive rupture.
- The pipe-work shall be securely mounted and guarded from physical damage.
- The national gas regulations shall also be observed when field-installed refrigerant pipes are required.
- Field-made refrigerant joints indoors shall be tightness tested. The test method shall have a sensitivity of 5 grams per year of refrigerant or better under a pressure of at least 0,25 times the maximum allowable pressure. No leak shall be detected; Mechanical connections shall be accessible for maintenance purposes.
- The joints shall not be reused, unless after re-flaring the pipe.
- Joints made in the installation between parts of the refrigerating system, with outdoor part charged, shall be made in accordance with the following.
  - A brazed, welded, or mechanical connection shall be made before opening the valves to permit refrigerant to flow between the refrigerating system parts. A vacuum valve shall be provided to evacuate the interconnecting pipe and/or any uncharged refrigerating system part.
  - Mechanical connectors used indoors shall comply with ISO 14903. When mechanical connectors are reused indoors, sealing parts shall be renewed. When flared joints are reused indoors, the flare part shall be re-fabricated.
  - Refrigerant tubing shall be protected or enclosed to avoid damage.
- That after completion of field piping for split systems, the field pipework shall be pressure tested with an inert gas and then vacuum tested prior to refrigerant charging, according to the following requirements:
  - The minimum test pressure for the low side of the system shall be the low side design pressure and the minimum test pressure for the high side of the system shall be the high side design pressure, unless the high side of the system, cannot be isolated from the low side of the system in which case the entire system shall be pressure tested to the low side design pressure.
- The appliance shall be stored in a well-ventilated area where the room size corresponds to the room area as specified.
- The appliances are designed for use at altitudes less than 2000m, may cause serious harm to the human body or surrounding things if used at altitudes 2000m and above.
- Keep any required ventilation openings clear of obstruction, don't block air inlet or air outlet, Otherwise, the cooling or heating capacity will be weakened, even cause system stop operating or safety hazard.
- Maintenance or repair of air conditioner using R32 refrigerant must be carried out after security check to minimize risk of incidents.
- Ensure no following objects under the indoor unit:
  - Microwaves, ovens and other hot objects.

- Computers and other high electrostatic appliances.
- Sockets that plug frequently.
- Installation, maintenance, service, repairing, removing and disposal operations, shall only be performed by the qualified personnel or recommended by the manufacturer.
- Every working procedure that affects safety means shall only be carried out by competent persons. Examples for such working procedures are:
  - breaking into the refrigerating circuit;
  - opening of sealed components;
  - opening of ventilated enclosures.
- Precautions shall be taken to avoid excessive vibration or pulsation to refrigerating piping for the transport and installation.
- Protection devices, piping and fittings shall be protected as far as possible against adverse environmental effects, for example the danger of water collecting and freezing in relief pipes or the accumulation of dirt and debris.
- When installing or repairing the air conditioner and the connecting line is not long enough, the entire connecting line shall be replaced with the connecting line of the original specification; extension is not allowed.
- Refrigerating systems shall be so installed as to minimize the likelihood of hydraulic shock damaging the system.
- The appliance shall be stored and installed so as to prevent mechanical damage from occurring.
- Work shall be undertaken under a controlled procedure so as to minimise the risk of a flammable gas or vapour being present while the work is being performed.
- All maintenance staff and others working in the local area shall be instructed on the nature of work being carried out. Work in confined spaces shall be avoided.
- The area shall be checked with an appropriate refrigerant detector prior to and during work, to ensure the non-existence of potentially toxic or flammable atmospheres. Ensure that the leak detection equipment being used is suitable for use with all applicable refrigerants, i.e. nonsparking, adequately sealed or intrinsically safe.
- If any hot work is to be conducted on the refrigerating equipment or any associated parts, appropriate fire extinguishing equipment shall be available to hand. Have a dry powder or CO<sub>2</sub> fire extinguisher adjacent to the charging area.
- No person carrying out work in relation to a refrigerating system which involves exposing any pipe work shall use any sources of ignition in such a manner that it can lead to the risk of fire or explosion. All possible ignition sources, including cigarette smoking, should be kept sufficiently far away from the site of installation, repairing, removing and disposal, during which refrigerant can possibly be released to the surrounding space. Prior to work taking place, the area around the equipment is to be surveyed to make sure that there are no flammable hazards or ignition risks. "No Smoking" signs shall be displayed.
- Ensure that the area is in the open or that it is adequately ventilated before breaking into the system or conducting any hot work. A degree of ventilation shall continue during the period that the work is carried out. The ventilation should safely disperse any released refrigerant and preferably expel it externally into the atmosphere.
- Anti-static precautions is necessary for installing and maintenance, for example, wear pure cotton clothes and gloves.
- If R32 refrigerant leakage occurs during the installation, operators shall immediately detect the concentration in indoor environment until it reaches a safe level. If the leakage affects the performance of the machine, please immediately stop the operation, and the air conditioner must be vacuumed firstly and be returned to the maintenance station for processing.
- Where electrical components are being changed, they shall be fit for the purpose and to the correct specification. At all times the maintenance and service guidelines of this manual shall be followed. If in doubt, consult the manufacturer's technical department for assistance. The following checks shall be applied to installations using R32:
  - The refrigerant charge is in accordance with the room size within which the refrigerant containing parts are installed.
  - The ventilation machinery and inlets and outlets are operating adequately and are not obstructed; and shall keep away from heat source, inflammable or explosive conditions.

- Marking to the equipment continues to be visible and legible. Markings and signs that are illegible shall be corrected.
- Refrigerating pipe or components are installed in a position where they are unlikely to be exposed to any substance which can corrode refrigerant containing components, unless the components are constructed of materials which are inherently resistant to being corroded or are suitably protected against being so corroded.
- Repair and maintenance to electrical components shall include initial safety checks and component inspection procedures. If a fault exists that could compromise safety, then no electrical supply shall be connected to the circuit until it is satisfactorily dealt with. If the fault cannot be corrected immediately but it is necessary to continue operation, an adequate temporary solution shall be used. This shall be reported to the owner of the equipment so all parties are advised. Initial safety checks shall include:
  - that capacitors are discharged: this shall be done in a safe manner to avoid possibility of sparking;
  - that no live electrical components and wiring are exposed while charging, recovering or purging the system;
  - that there is continuity of earth bonding.
- Sealed electrical components shall not be repaired.
- Check that cabling will not be subject to wear, corrosion, excessive pressure, vibration, sharp edges or any other adverse environmental effects. The check shall also take into account the effects of aging or continual vibration from sources such as compressors or fans.
- Under no circumstances shall potential sources of ignition be used in the searching for or detection of refrigerant leaks. A halide torch (or any other detector using a naked flame) shall not be used.
- Air-tightness test shall be carried out as guaranteed. Charging oxygen, acetylene or other inflammable and toxic gases during leakage inspection and air-tightness test may lead to explosions. It recommended to use nitrogen gas for this test.
- The following leak detection methods are deemed acceptable for all refrigerant systems.
  - Electronic leak detectors may be used to detect refrigerant leaks but, in the case of flammable refrigerants, the sensitivity can be inadequate, or can need re-calibration. (Detection equipment shall be calibrated in a refrigerant-free area.) Ensure that the detector is not a potential source of ignition and is suitable for the refrigerant used. Leak detection equipment shall be set at a percentage of the LFL of the refrigerant and shall be calibrated to the refrigerant employed, and the appropriate percentage of gas (no more than 25 %) is confirmed.
  - The fluid used in leak detection is applicable to most refrigerants. But do not use chloride solvents to prevent the reaction between chlorine and refrigerants and the corrosion of copper pipeline.
  - If a leak is suspected, all naked flames shall be removed/extinguished.
  - If a leakage of refrigerant is found which requires brazing, all of the refrigerant shall be recovered from the system, or isolated in a part of the system remote from the leak. Removal of refrigerant shall be according to this manual.
- When breaking into the refrigerant circuit to make repairs – or for any other purpose – conventional procedures shall be used. However, for flammable refrigerants it is important that best practice is followed since flammability is a consideration. The following procedure shall be adhered to:
  - safely remove refrigerant following local and national regulations;
  - evacuate;
  - purge the circuit with inert gas;
  - continuously flush with inert gas when using flame to open circuit;
  - open the circuit.
- The refrigerant charge shall be recovered into the correct recovery cylinders.
- Purging of the refrigerant circuit shall be achieved by breaking the vacuum in the system with inert gas and continuing to fill until the working pressure is achieved, then venting to atmosphere, and finally pulling down to a vacuum. This process shall be repeated until no refrigerant is within the system. The system shall be vented down to atmospheric pressure to enable work to take place.
- Ensure that the outlet of the vacuum pump is not close to any potential ignition sources and that ventilation is available.
- In addition to conventional charging procedures, the following requirements shall be followed.
  - Ensure that contamination of different refrigerants does not occur when using charging equipment.

Hoses or lines shall be as short as possible to minimise the amount of refrigerant contained in them.

- Cylinders shall be kept in an appropriate position according to the instructions.
- Ensure that the refrigerating system is earthed prior to charging the system with refrigerant.
- Label the system when charging is complete (if not already labelled).
- Extreme care shall be taken not to overfill the refrigerating system.
- Prior to recharging the system, it shall be pressure-tested with the appropriate purging gas. The system shall be leak-tested on completion of charging but prior to commissioning. A follow up leak test shall be carried out prior to leaving the site.
- Before carrying out the decommissioning procedure, it is essential that the technician is completely familiar with the equipment and all its detail. It is recommended good practice that all refrigerants are recovered safely. Prior to the task being carried out, an oil and refrigerant sample shall be taken in case analysis is required prior to re-use of recovered refrigerant. It is essential that electrical power is available before the task is commenced.
  - Become familiar with the equipment and its operation.
  - Isolate system electrically.
  - Before attempting the procedure, ensure that:
    - (a) mechanical handling equipment is available, if required, for handling refrigerant cylinders;
    - (b) all personal protective equipment is available and being used correctly;
    - (c) the recovery process is supervised at all times by a competent person;
    - (d) recovery equipment and cylinders conform to the appropriate standards.
  - Pump down refrigerant system, if possible.
  - If a vacuum is not possible, make a manifold so that refrigerant can be removed from various parts of the system.
  - Make sure that the cylinder is situated on the scales before recovery takes place.
  - Start the recovery machine and operate in accordance with instructions.
  - Do not overfill cylinders (no more than 80% volume liquid charge).
  - Do not exceed the maximum working pressure of the cylinder, even temporarily.
  - When the cylinders have been filled correctly and the process completed, make sure that the cylinders and the equipment are removed from site promptly and all isolation valves on the equipment are closed off.
  - Recovered refrigerant shall not be charged into another refrigerating system unless it has been cleaned and checked.
- Equipment shall be labelled stating that it has been de-commissioned and emptied of refrigerant. The label shall be dated and signed. For appliances containing flammable refrigerants, ensure that there are labels on the equipment stating the equipment contains flammable refrigerant.
- When removing refrigerant from a system, either for servicing or decommissioning, it is required to follow good practice so that all refrigerants are removed safely.
- When transferring refrigerant into cylinders, ensure that only appropriate refrigerant recovery cylinders are employed. Ensure that the correct number of cylinders for holding the total system charge is available. All cylinders to be used are designated for the recovered refrigerant and labelled for that refrigerant (i.e. special cylinders for the recovery of refrigerant). Cylinders shall be complete with pressure-relief valve and associated shut-off valves in good working order. Empty recovery cylinders are evacuated and, if possible, cooled before recovery occurs.
- The recovery equipment shall be in good working order with a set of instructions concerning the equipment that is at hand and shall be suitable for the recovery of the flammable refrigerant. Consult manufacturer if in doubt. In addition, a set of calibrated weighing scales shall be available and in good working order. Hoses shall be complete with leak-free disconnect couplings and in good condition.
- The recovered refrigerant shall be processed according to local legislation in the correct recovery cylinder, and the relevant waste transfer note arranged. Do not mix refrigerants in recovery units and especially not in cylinders.
- If compressors or compressor oils are to be removed, ensure that they have been evacuated to an acceptable level to make certain that flammable refrigerant does not remain within the lubricant. The compressor body shall not be heated by an open flame or other ignition sources to accelerate this process. Draining of oil from a system shall be carried out safely.
- Disposal of equipment shall follow the national regulations.
- The storage of the appliance should be in accordance with the applicable regulations or instructions, whichever is more stringent.



- The maximum number of pieces of equipment permitted to be stored together notes by each product package information and standard follows ISO 780-2015.
- After completing the installation work, check that the refrigerant gas does not leak throughout the system.
- When installing the unit in a small room, take measures to keep the refrigerant concentration from exceeding allowable safety limits. Excessive refrigerant leaks, in the event of an accident in a closed ambient space, can lead to oxygen deficiency.
- When installing or relocating the air conditioner, do not let any other substances besides R32, such as air, enter the refrigerant circuit. The presence of air or foreign matter in the refrigerant circuit causes an abnormal pressure rise, which may result in equipment damage and even injury.
- Refrigerant R32 in the system must be kept clean, dry, and tight.
  - Clean and Dry -- Foreign materials (including mineral oils such as SUNISO oil or moisture) should be prevented from getting into the system.
  - Tight -- R32 does not contain any chlorine, does not destroy the ozone layer, and does not reduce the earth's protection against harmful ultraviolet radiation. R32 can contribute to the greenhouse effect if it is released.
- Only use tools for R32, such as a gauge manifold, charge hose, gas leak detector, reverse flow check valve, refrigerant charge base, vacuum gauge, or refrigerant recovery equipment.
- If the conventional refrigerant and refrigerator oil are mixed in R32, the refrigerant may deteriorate.
- Appliance shall be installed, operated and stored in a room with a floor area larger than  $A_{min}(m^2)$  [ $A_{min}(m^2)$  - see table below].
- The installation of pipe-work shall be kept to a room with a floor area larger than  $A_{min}(m^2)$  [ $A_{min}(m^2)$  - see table below].
- The unit has requirements on the minimum required room area ( $A_{min}$ ) used with different refrigerant charging amount (m). The total amount of refrigerant charged in the system corresponds to the room area installed in the table below. The calculation result is based on the ceiling suspended unit, and the installation height is no less than 2.2m.

Minimum required room area for each refrigerant amount charged

Ceiling Suspended(for single room)					
Installation Height: 2.2m					
m(kg)	$A_{min}(m^2)$	m(kg)	$A_{min}(m^2)$	m(kg)	$A_{min}(m^2)$
≤1.842	-	2.80	8.291	4.00	11.845
1.843	5.458	3.00	8.884	4.20	12.437
2.00	5.922	3.20	9.476	4.40	13.029
2.20	6.515	3.40	10.068	4.60	13.622
2.40	7.107	3.60	10.660	4.80	14.585
2.60	7.699	3.80	11.253	5.00	15.826

## CHECKING PRODUCT RECEIVED

- Upon receiving this product, inspect it for any shipping damage. Claims for damage, either apparent or concealed, should be filed immediately with the shipping company.
- Check the model number, electrical characteristics (power supply, voltage and frequency) and accessories to determine if they are correct.

The standard utilization of the unit shall be explained in these instructions. Therefore, the utilization of the unit other than those indicated in these instructions is not recommended. Please contact your local agent, as the occasion arises.

Hitachi's liability shall not cover defects arising from the alteration performed by a customer without Hitachi's consent in a written form.

# Table of Contents

## Operation Manual

1. Safety Summary .....	1
2. System Description .....	2
3. Before Operation .....	2
4. Operation Method .....	2
5. Setting of Automatic Swing Louver .....	2
5.1 Common .....	2
6. Filter Cleaning.....	3
6.1 Taking Out the Filter.....	3
6.2 Clean the Filter .....	3
6.3 Reset of Filter Indication.....	3
7. Troubleshooting .....	3
7.1 If Trouble Still Remains .....	3
7.2 No Operation .....	3
7.3 Not Cooling or Heating Well .....	4
7.4 This is Not Abnormal.....	4

## Installation & Maintenance Manual

1. Safety Summary .....	5
2. Structure .....	5
2.1 Indoor Unit & Refrigerant Cycle.....	5
2.2 Necessary Tools and Instrument List for Installation .....	5
3. Transportation and Handling .....	6
3.1 Transportation.....	6
3.2 Handling of Indoor Unit .....	6
4. Indoor Unit Installation.....	7
4.1 Factory-supplied Accessories .....	8
4.2 Initial Check.....	9
4.3 Installation.....	10
5. Refrigerant Piping Work .....	11
5.1 Piping Materials.....	12
5.2 Piping Connection.....	12
6. Drain Piping .....	14
7. Electrical Wiring.....	16
7.1 General Check .....	17
7.2 Electrical Wiring Connection .....	17
8. Test Run .....	19
9. Safety and Control Device Setting.....	19
10. Common .....	19
10.1 Field Minimum Wire Sizes for Power Source.....	19
10.2 Setting of Dip Switches .....	20

# Operation Manual

## 1. Safety Summary

### **DANGER**

- Do not pour water into the indoor or outdoor unit. This product contains electrical components and if wet, can cause serious electrical shock.
- Do not tamper with or adjust safety devices inside the indoor unit or outdoor unit. If these devices are tampered with or readjusted, it may cause a serious accident.
- Do not open the service cover or access panel for the indoor or outdoor unit without turning OFF the main power supply.

### **WARNING**

- Refrigerant leakage can cause difficulty with breathing due to insufficient air. If leakage occurs, turn OFF the main switch, and contact your service contractor.
- Do not use any sprays such as insecticide, lacquer, hair spray or other flammable gases within approximately one (1) meter from the system.
- If earth leakage breaker (ELB) or fuse is frequently activated, stop the system and contact your service contractor.

### **CAUTION**

- If the supply cord is damaged, it must be replaced by the manufacturer, its service agent or similarly qualified persons in order to avoid a hazard.
- Means for disconnection from the supply mains, which have a contact separation in all poles that provide full disconnection under overvoltage category III conditions, must be incorporated in the fixed wiring in accordance with AS/NZS 3000.
- The appliance shall be installed in accordance with relevant local and national wiring regulations. The maximum working pressure is 4.15MPa. This maximum working pressure shall be considered when connecting the indoor unit to outdoor unit.
- The indoor unit is suitable for refrigerant R32 only and shall only be connected to outdoor unit suitable for the same refrigerant (R32). Please refer to the instruction manual of the outdoor unit to be used combined with the indoor unit for the refrigerant charging.

#### NOTE:

- It is recommended that the room be ventilated every 3 to 4 hours.

## 2. System Description

## 2. System Description

The heat pump air conditioner is designed to offer cooling, heating, dehumidification and fan operations. These operation modes are controlled by the remote control switch.

Table 2.1 Indoor Unit Type List

Indoor Unit Type	Standard Capacity (HP)					
	2.0	2.5	3.0	4.0	5.0	6.0
Ceiling Suspended Type	○	○	○	○	○	○

○ : Available

## 3. Before Operation

### CAUTION

- Supply electrical power to the system for approximately 12 hours before start-up after long shut down. Do not start the system immediately after power supply, it may cause a compressor failure, because the compressor is not heated well.
- Make sure that the outdoor unit is not covered with snow or ice. If covered, remove it by using hot water (approximately 50°C). If the water temperature is higher than 50°C, it will cause damage to plastic parts.

When the system is started after a shutdown longer than approximately 3 months it is recommended that the system be checked by your service contractor.

Turn OFF the main switch when the system is stopped for a long period of time. If the main switch is not turned OFF, electricity is consumed, because the oil heater is always energized during compressor stopping.



## 4. Operation Method

Refer to the appropriate manual for the wired remote controller (PC-ARFG2-Z) or wireless remote controller (PC-LH8QE).

## 5. Setting of Automatic Swing Louver

### 5.1 Common

When the SWING LOUVER switch is pressed, the swing louver starts its operation.

When “” is moving, it indicates the operation of the louver continuously. When the swinging operation of the louver is not required, press the SWING LOUVER switch again. The louver is stopped at an angle indicated by the direction of this mark “”.

#### NOTES:

- There is a short time lag between the indication on the wired controller and the units actual louver angle.
- When the louver is set to auto-swing and then fixed to blow in a set direction, the louver will go through another swing cycle and then stop at the set direction.
- In order to prevent cold draughts in the heating mode, at certain times, the louver direction will be set to blow in a horizontal direction. This occurs during the defrost cycle and when heating cycle (re)starts. Once the discharge air temperature is greater than 30°C, the louver will resume the swing operation or angle.
- During the defrosting operation, fan stops running.

### CAUTION

- Do not turn the air louver by hand. If moved, the louver mechanism will be damaged.

## 6. Filter Cleaning

### CAUTION

- Do not operate the system without the air filter to protect the indoor unit heat exchanger against being clogged.

Turn Off the main power switch before taking out the filter. (The previous operation mode may appear.)

### 6.1 Taking Out the Filter

The indication, "FILTER" is shown on the display of the remote control switch after approximately 1,200 hour operation. Take out the air filter according to the following steps.

#### Step1

Open the air inlet grille after removing screw covers and fixing screws.

#### Step2

Take out the air filter from the air inlet grille by supporting the air grille and lifting the air filter after detaching the filter from clips.

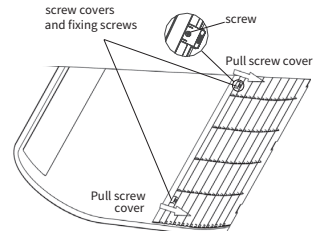

Fig.7.1 Open the air inlet grille

### 6.2 Clean the Filter

Clean the air filter according to the following steps.

#### Step1

Use a vacuum cleaner or let water flow onto the air filter for removing the dirt from the air filter.

### CAUTION

- Do not use hot water higher than approximately 40°C.

#### Step2

Dry the air filter in the shade after shaking off moisture.

### 6.3 Reset of Filter Indication

After cleaning the air filter, press the "RESET" button on the wired controller. The FILTER indication will disappear and the filter timer will be reset.

## 7. Troubleshooting

### CAUTION

- When overflow of drain water from the indoor unit occurs, stop the operation and contact your contractor.
- When you smell or see white smoke coming from the unit, turn OFF the main power supply and contact your contractor.

### 7.1 If Trouble Still Remains

If the trouble still remains even after checking the following, contact your contractor and inform them of the following items.

- Unit Model Name
- Content of Trouble
- Alarm Code No. on Liquid Crystal Display

### 7.2 No Operation

Check whether "TEMP" is set at the correct temperature.

### 7.3 Not Cooling or Heating Well

- Check for obstruction of air flow of the outside or inside units.
- Check if too much heat source exists in the room.
- Check if the air filter is clogged with dust.
- Check to see if the doors or windows are opened or not.
- Check if the temperature condition is not within the operation range.

### 7.4 This is Not Abnormal

- **Smells from Indoor Unit**

Smell adheres on indoor unit after a long period of time. Clean the air filter and panels or allow a good ventilation.

- **Cracking or Ticking Noise from The Unit**

During the cooling and heating modes, a slight cracking or ticking noise may be heard occasionally. This is due to the expansion and contracting of parts. This is normal.

- **Steam from Outdoor Heat Exchanger**

During defrosting operation, ice on the outdoor heat exchanger is melted, resulting in mist being discharged from the outdoor fans. This is normal.

- **Condensation on The Air Discharge Louvre**

When the cooling operation continues for a long period of time under high humidity conditions (Higher than 27°C/80% R.H.), dew can form on the air panel.

- **Refrigerant Flow Sound**

While the system is being started or stopped, sound from the refrigerant flow may be heard.

NOTE:

- Except for a long period of shutdown, keep the main switch ON, since the oil heater is energized when the compressor is stopping.

# Installation & Maintenance Manual

## 1. Safety Summary

### WARNING

- Do not perform installation work, refrigerant piping work, drain piping and electrical wiring connection without referring to the installation manual.
- Check that the ground wire is securely connected.
- Connect a fuse of specified capacity.
- Pay a special attention to the installation location, such as a basement, etc. where refrigerant can stay, since refrigerant is heavier than air.

### CAUTION

- Do not install the indoor unit, outdoor unit, remote control switch and cable within approximately 3 meters from strong electromagnetic wave radiators such as medical equipment.

## 2. Structure

### 2.1 Indoor Unit & Refrigerant Cycle

Regarding the structural drawings and the refrigerant cycle diagrams, refer to Technical Catalogue.

### 2.2 Necessary Tools and Instrument List for Installation

No.	Tool	No.	Tool
1	Handsaw	12	Charging Cylinder
2	Screwdriver	13	Gauge Manifold
3	Vacuum Pump	14	Cutter for Wires
4	Refrigerant Gas Hose	15	Gas Leak Detector
5	Megohmmeter	16	Leveler
6	Copper Pipe Bender	17	Clamper for Solderless Terminals
7	Manual Water Pump	18	Hoist (for Indoor Unit)
8	Pipe Cutter	19	Ammeter
9	Brazing Kit	20	Voltage Meter
10	Hexagon Wrench	21	Wrench
11	Spanner		

#### NOTE:

- About vacuum pump, gas hose, charging cylinder, gauge manifold, please use suitable equipments for R32 respectively. Do not mix other refrigerant.

## 3. Transportation and Handling

### 3.1 Transportation

Transport the product as close to the installation location as practical before unpacking.



- Do not put any material on the product.

### 3.2 Handling of Indoor Unit



- Do not insert any objects into the indoor unit and check to ensure that none exists in the indoor unit before the installation and test run. Otherwise, a fire or failure, etc. may occur.



- Do not hold the resin covers when holding or lifting the indoor unit.

To avoid damage to the resin covers, before lifting or moving the indoor unit, put a cloth on the resin covers.

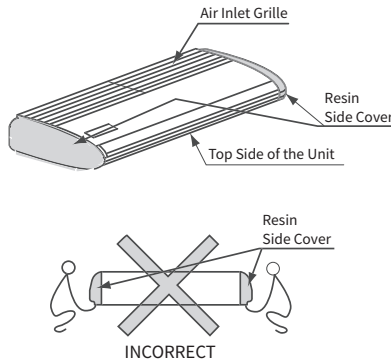

Fig.3.1 Side Covers

Remove the air inlet grille and resin side cover before installation.

- Remove the air inlet grille
  - (1) Open the air inlet grille after removing screw covers and fixing screws as is shown in Fig 7.1 of section 1.
  - (2) Carefully push the air inlet grille away from the mounting plate of indoor unit.
  - (3) Remove the air inlet grille.
- Remove the resin side cover
  - (1) Remove fixing screw of side cover.
  - (2) Carefully push the side cover away from the indoor unit approximately 10mm forward.
  - (3) Remove the resin side cover.



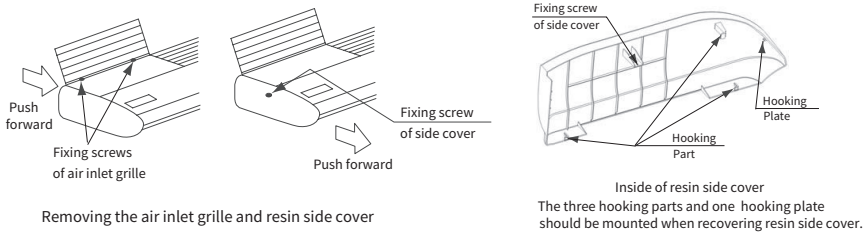
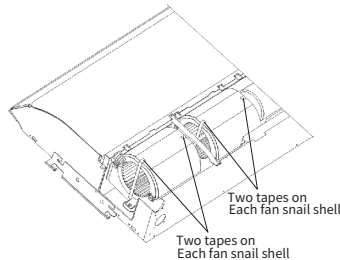

Fig.3.2 Removing the air inlet grille and resin side cover

Remove the fixing adhesive tape on the fan shell and outer panel before installation. The tape is just used for fixing during transportation.



The swing louver is operated by a small motor and gears. Do not move the swing louver by hand or other objects. This can damage the mechanism of the automatic swing louver.

## 4. Indoor Unit Installation

### ! DANGER

- Do not install the indoor unit in a flammable environment to avoid fire or an explosion.
- Do not install the indoor unit in the laundry.
- The indoor unit should be positioned in a place where:
  - (1) both the air inlet and air outlet are unobstructed,
  - (2) the unit is not exposed to direct sunlight,
  - (3) drainage occurs easily,
  - (4) the unit is away from sources of heat or steam,
  - (5) there is no source of machine oil vapor (this may shorten the indoor unit service life),
  - (6) cool/warm air is circulated throughout the room,
  - (7) the unit is away from electronic ignition type fluorescent lamps (inverter or rapid start type) as they may affect the remote controller range,

### ! WARNING

- Check to ensure that the ceiling slab is strong enough. If not strong enough, the indoor unit may fall down on you.
- Do not install the indoor unit outdoors. If installed outdoors, an electric hazard or electric leakage will occur.
- This indoor unit must be installed in ceiling suspended type. Floor type installation is forbidden in field. It is recommended that indoor units be installed 2.5 to 3 meters from the floor level when mounted below the ceiling.

## 4. Indoor Unit Installation











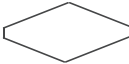



### 4.1 Factory-supplied Accessories

Check to ensure that the following accessories are packed with the indoor unit.

**NOTE:**

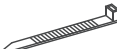
- If any of these accessories are not packed with the unit, please contact your contractor.

Table 4.1 Factory-supplied Accessories

Accessory	Q'ty	Purpose
Cardboard template 	1	For adjusting space and position of the unit
Washer with Insulation Material (M10) 	4	For unit installation
Washer (M10) 	4	
Drain Hose 	1	For drain hose connection
Hose Clamp 	2	
Clamp of Drain Pipe Connection 	1	
Drain Pipe Connection 	1	
Packing (10×T38×165) 	1	For covering clamp of drain pipe connection
Insulation (22ID) 	1	For refrigerant piping connection
Insulation (43ID) 	1	
Cord Clamp 	2	For fixing remote control switch wiring and insulation of piping
Cord Clamp 	7	
Packing (5T×50×200) 	1	For covering wiring connection
Packing (5T×270×270) 	1	For covering drain connection
Ring Core 	1	For anti-electromagnetic interference of transmission cables between outdoor and indoor units

## 4.2 Initial Check

- Install the indoor unit with a proper clearance around it for operation and maintenance working space, as shown in Fig.4.1.

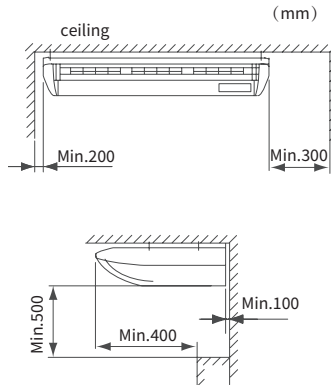

Fig.4.1 Operation and Maintenance Space

- Check to ensure that the ceiling or wall has a sufficient strength to hang the indoor unit.
- Consider the air distribution from the indoor unit to the space of the room, and select a suitable location so that uniform air temperature in the room can be obtained.
- Do not install flammable parts in the service space for the indoor unit.
- Avoid obstacles which may hamper the air intake or the air discharge flow.
- Do not install the indoor unit in a machinery shop or kitchen where vapor from oil enter into the indoor unit. The oil deposits will adhere to components within the unit - including the heat exchanger, which may corrode or weaken internal components.
- Pay attention to the following points when the indoor unit is installed in a hospital or other facilities where there are electronic waves from medical equipment, etc.
  - (a) Do not install the indoor unit. There is a risk of electromagnetic interference particularly to the wired controller, the electrical box and interconnecting wiring.
  - (b) Install the indoor unit and components as far as practical or at least 3 meters from the electromagnetic source.
  - (c) Prepare a steel box and install the remote control switch in it. Prepare a steel conduit tube and wire the remote control cable in it. Then, connect the ground wire with the box and the tube.
  - (d) Install a noise filter when the power supply emits harmful noises.
- To avoid corrosion to the heat exchangers, do not install the indoor unit in an acid or alkaline environment.

## 4. Indoor Unit Installation

### 4.3 Installation

#### 4.3.1 Mounting of Suspension Bolts

##### Step1

Select final location and installation direction of the indoor unit paying careful attention to the space for the piping, wiring and maintenance.

##### Step2

Mount suspension bolts, as shown in Fig.4.2.

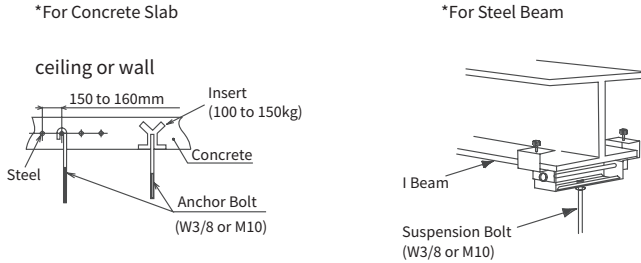

Fig.4.2 Mounting of Suspension Bolts

#### 4.3.2 Installation Template

- (1) A template for installation is in the carton of indoor unit. Use it to decide an installation location and direction of the unit.
- (2) Press the Pattern Board tightly onto the surface, mark out the hole position for suspension bolts with a pencil.

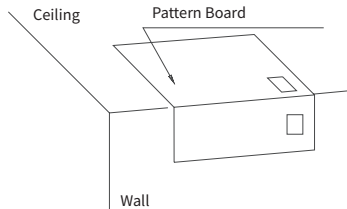
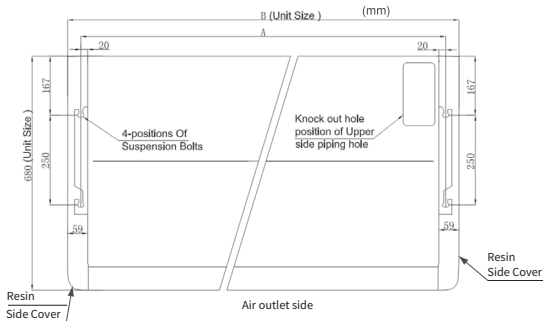

Fig.4.3 Pattern Board

#### 4.3.3 Mounting Position of the Indoor Unit



Model(HP)	A	B
2.0-2.5	912	990
3.0-6.0	1502	1580

Fig.4.4 Mounting Position

### 4.3.4 Mounting the Indoor Unit

(1) Mount the nuts and washers to the suspension bolts.

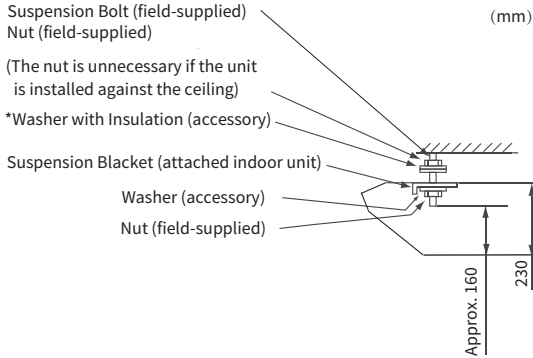

Fig.4.5 Mounting Nuts and Washers

(2) Lift the Indoor Unit by hoist, and do not put any force on the resin covers.

(3) Secure the indoor unit using the nuts, washers.

(4) Adjusting of the Unit Level

(a) Check to ensure that foundation is flat, taking into account the maximum foundation gradient.

Install the unit with an incline of at least 10mm towards the rear of the unit to ensure proper condensate drainage.

Install the unit with an incline of at least 10mm towards the drain outlet side to ensure proper condensate discharge.

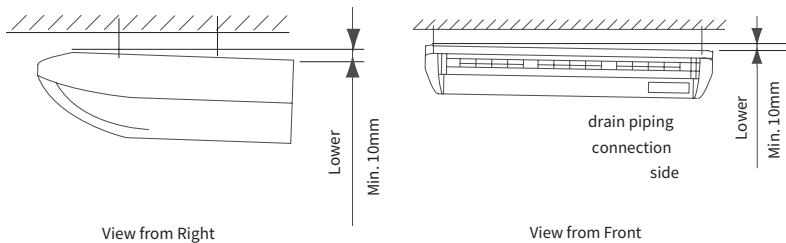

Fig.4.6 Inclination of Unit for Drain for ceiling installation

(b) Tighten the bolts of the sling nuts with the suspension brackets after adjustment is completed.

## 5. Refrigerant Piping Work



- Use refrigerant R32 in the refrigerant cycle. Do not charge oxygen, acetylene or other flammable and poisonous gases into the refrigerant cycle when performing a leakage test or an air-tight test. These types of gases are extremely dangerous and cause an explosion. It is recommended that dry nitrogen be used for these types of tests.

## 5. Refrigerant Piping Work

### 5.1 Piping Materials

- (1) Prepare locally-supplied copper pipes suitable for use with R32 refrigerant and comply with local regulations.
- (2) Select the piping size from the following table.

Table 5.1 Piping Size mm (in.)

Model(HP)	Gas Piping	Liquid Piping
2.0-3.0	Φ 12.7 (1/2)	Φ 6.35 (1/4)
4.0-6.0	Φ 15.88 (5/8)	Φ 9.53 (3/8)

- (3) Select clean copper pipes. Make sure there is no dust and moisture inside. Blow the inside of the pipes with nitrogen or dry air, to remove any dust or foreign materials before connecting pipes.

### 5.2 Piping Connection

- (1) Position of piping connection is shown in Fig.5.1.

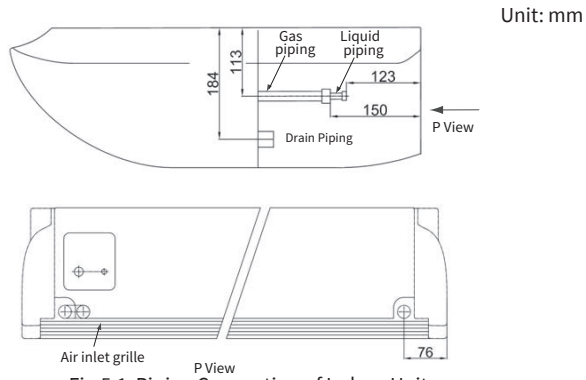
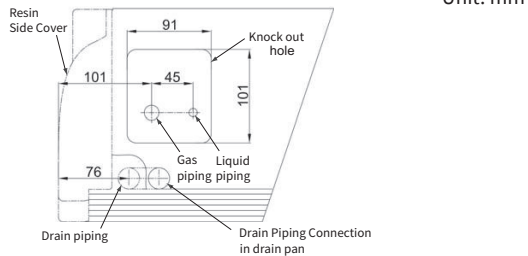
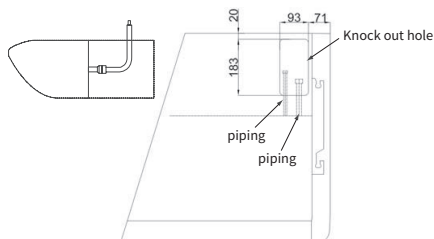

Fig.5.1 Piping Connection of Indoor Unit

- (a) Piping from Rear Side



- (b) Piping from Upper Side



(c) Piping from Right Side Cover

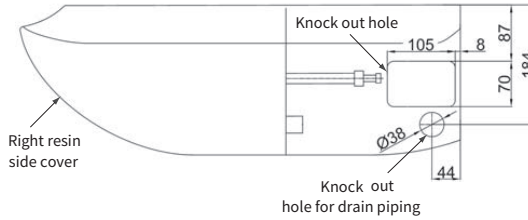

(2) Piping work should be performed under the unit. Open the air inlet grille as is shown in Fig.7.1 of section 1 and remove the side cover as is shown in Fig.3.2 before the piping work.

**NOTES:**

- Cut out the knock-out hole along the groove in the Right Side Cover using saw blade to avoid sharp edges of piping from right side.
- Seal the clearance around pipes with seal material to prevent ingress of dirt and protect wires from damage by sharp edge after piping and wiring.

(3) When tightening the flare nut, use two spanners as shown in Fig.5.2.

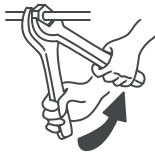

Pipe Size	Tightening Torque (N·m)
Φ6.35mm	20
Φ9.53mm	40
Φ15.88mm	80

Fig.5.2 Tightening Work of Flare Nut

**※Flaring Dimension**

Perform the flaring work as shown below.

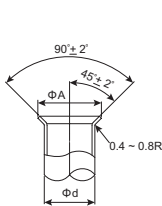

Unit: mm(in.)

Diameter Φd	A <sup>+0</sup> <sub>-0.4</sub>
	R32
6.35(1/4)	9.1
9.53(3/8)	13.2
12.7(1/2)	16.6
15.88(5/8)	19.7

(4) After connecting the refrigerant piping, seal the refrigerant pipes by using the factory-supplied insulation material as shown in Fig.5.3.

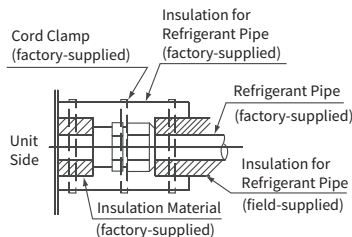
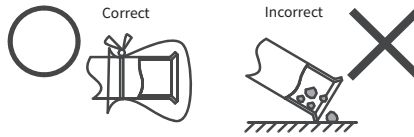

Fig.5.3 Insulation on Pipes

## 6. Drain Piping

### CAUTION

- Cap the end of the pipe when the pipe is to be inserted through a hole.
- Do not put pipes on the ground directly without a cap or vinyl tape at the end of the pipe.



- (5) Evacuation and refrigerant charging procedures should be performed according to “Installation & Maintenance Manual” of the outdoor unit.

## 6. Drain Piping

### CAUTION

- Ensure a downward slope for the drain pipe, since condensate can flow back to the indoor unit and leak into the room.
- Do not connect the drain pipe to sanitary or sewage drains or any other type of drainage piping.
- When the common drain pipe is connected with other indoor units, the connected position of each indoor unit must be higher than the common pipe. The pipe size of the common drain pipe must be large enough to cater for the condensate from multiple units connected to the common drain pipe.
- After performing drain pipe work and electrical wiring, check to ensure that water flows smoothly.

The standard direction of drain pipe connection is right side as viewed from the discharge grilles. However, drain pipe can be connected to the left side of the unit to suit the installed location and access to the drainage point.

### (1) For Right Side Connection

- Insert the Drain Pipe Connection into Drain Boss with clamp until the connection reaches the end of the drain pan.
- Insert the Drain Hose and Drain Pipe with clamps until reaching the end.
- Tighten the screw for the hose clamp in order to hold the hose around the drain connection without any leakage of drain water as shown in Fig.6.1.
- Insulate the drain hose around the hose clamp to prevent any condensation as shown in Fig. 6.1.

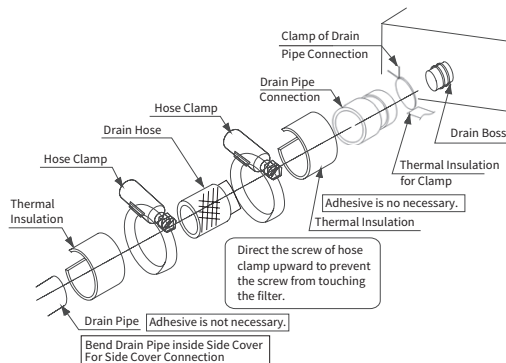

Fig.6.1 Connecting Drain Piping



(2) For Left Side Connection

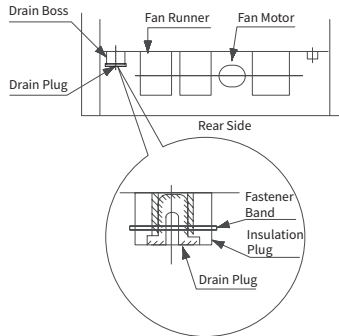

Fig.6.2 Drain Plug

Remove the drain plug of the left-side drain boss as indicated in the following procedure.

- (a) Cut the fastener.
- (b) Remove the insulation material.
- (c) Remove the drain plug.
- (d) Insert the drain plug into the right-side drain boss by using a driver as shown in Fig.6.3.

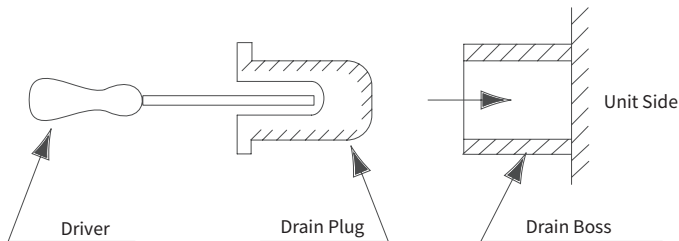

Fig.6.3 Inserting Drain Plug

- (e) After inserting the drain plug into the right-side drain boss, seal it by using a water-proof chloride type sealing material and secure it with fastener.

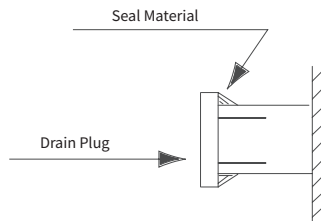

Fig.6.4 Sealing Joint Part

- (f) Wrap the insulation material around the drain connection.
- (g) Connect the drain hose to the left-side drain connection as the same as the right side drain connection procedure.

(3) Connecting a Drain Piping

- (a) Prepare a polyvinyl chloride (PVC) tube with an outer diameter of 32mm. (VP25)
- (b) Pay attention to the position of the drain pipe. Maintain a downward slope of 1/25 to 1/100. Do not create an upper slope or rise for the drain piping.
- (c) Seal the connecting part of the drain pipe by using the water-proof chloride type sealing material.

## 7. Electrical Wiring

- (d) Wrap the insulation material around the connecting part.
- (e) Fasten the drain pipe to the connecting part with the factory-supplied clamp.

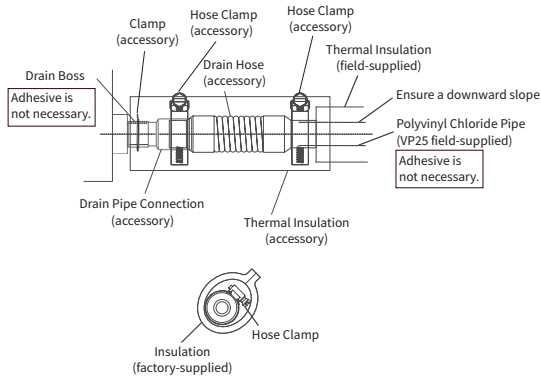

Fig.6.5 Wrapping Insulation Material

- (f) Do not connect the drain pipes to a sanitary or sewage drain or any other type of drainage pipe.
- (g) When installing the pipe, do not tie the drain pipe and refrigerant pipe together.
- (h) After completing the drain pipe work, pour water into the drain pan and check to ensure that water can flow smoothly.

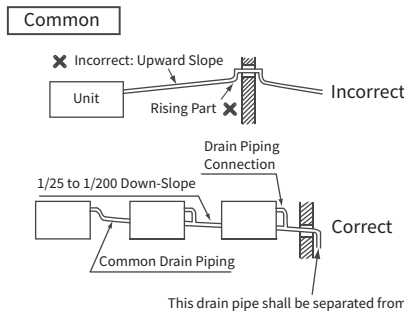

Fig.6.6 Drain Piping

## 7. Electrical Wiring

### ⚠ WARNING

- Turn OFF the main power switch to the indoor unit and the outdoor unit and wait for more than 10 minutes before electrical wiring work or a routine check is performed.
- Check to ensure that the indoor fan and the outdoor fan have stopped before electrical wiring work or a routine check is performed.
- Protect the wires, drain pipe, electrical parts, etc. from rodents or other pests.
- Tighten screws according to the following torque.
  - M3.5 : 1.2 N·m
  - M5 : 2.0~2.4 N·m
- The ground wire must be longer than the current-carrying conductor when installing the power cord.
- Using the air conditioner power terminal to transfer the power cord is strictly prohibited. A power distribution box can be used to expand the power distribution on the indoor unit.
- A switch that can ensure all-pole disconnection should be installed between the power supply and air conditioning unit, and the contact spacing of this switch should be no less than 3mm.

### ⚠ CAUTION

- Wrap the accessory packing around the wires, and plug the wiring connection hole with the sealing

material to protect the product from any condensate water or pests.

- Tightly secure the wires with the cord clamp inside the indoor unit.
- Secure the cable of the remote control switch using the cord clamp inside the electrical box.

### 7.1 General Check

- (1) Make sure that the field-supplied electrical components (main power switches, circuit breakers, wires, conduit connectors and wire terminals) have been properly selected in accordance with local laws and regulations.
- (2) Check to ensure that the power supply voltage is within  $\pm 10\%$  of the rated voltage.
- (3) Check the capacity of the electrical wires. If the power source capacity is too low, the system cannot be started due to the voltage drop.
- (4) Check to ensure that the ground wire is connected.
- (5) Power Source Main Switch  
Install a Power Source Main Switch in accordance with relevant local laws and regulations. The distance between switch contacts should be greater than 3.5mm when the switch is off.

### 7.2 Electrical Wiring Connection

The electrical wiring connection for the indoor unit is shown in Fig.7.3.

- (1) Connect the cable of the wired controller or an optional extension cable to the terminals inside the electrical box through the connecting hole.
- (2) Connect the power supply and earth wires to the terminals in the electrical box.
- (3) Connect the wires between the indoor unit and the outdoor unit to the terminals in the electrical box.
- (4) Tightly clamp the wires using the cord clamp.

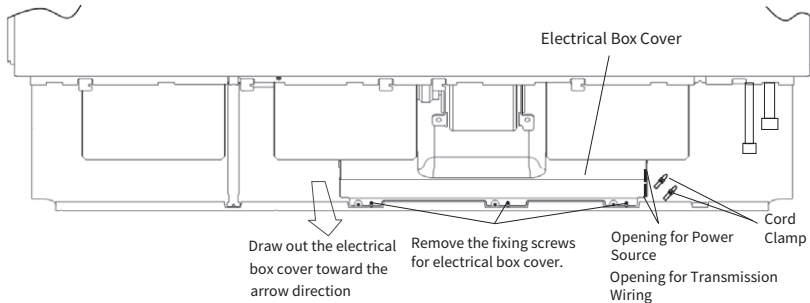

Fig.7.1 Remove electrical box cover

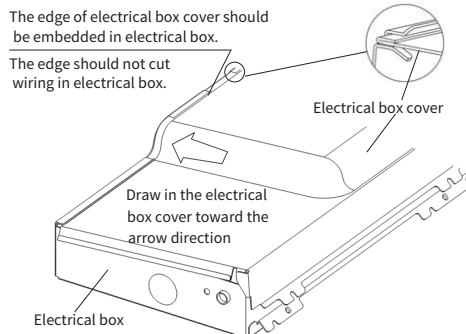

Fig.7.2 Attach electrical box cover

## 7. Electrical Wiring

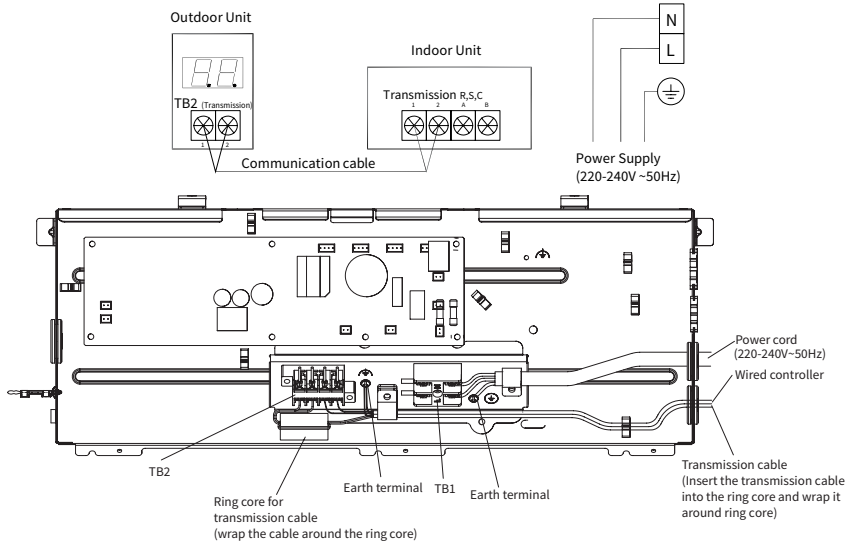

Fig.7.3 Electrical Wiring Connection for Indoor Unit

### CAUTION

- Before electrical wiring work, turn OFF the power source. If the connectors are connected without turning OFF the power source, the auto-swing louver can not activate.

### NOTES:

- Please knock down the knockout hole as required, and plug the excess gap after installation to prevent insects and other foreign material from entering.

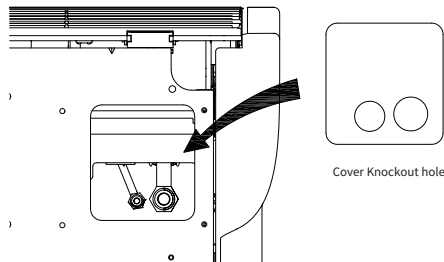

- The ring core needs to be installed on the transmission cable between the fixed wire clamp and TB2, where additional insulation rubber is peeled off.

### [Procedure]

Insert the transmission cable into the ring core as shown in the below figure before connecting to the terminal board. Wrap the transmission cable around the ring core. Fix the cable and the ring core by using the band (accessory) in the electrical box.

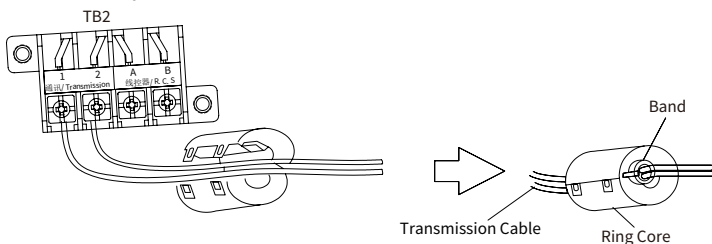

## 8. Test Run

Test run should be performed according to “Installation & Maintenance Manual” of the outdoor unit or wired remote controller.

### WARNING

- Do not operate the system until all need to add a table with the checks to be made.
  - (a) Check to ensure that the electrical resistance is more than 1 megohm, by measuring the resistance between ground and the terminal of the electrical parts. If not, do not operate the system until the electrical leakage is found and repaired.
  - (b) Check to ensure that the stop valves of the outdoor unit are fully opened, and then start the system.
  - (c) Check to ensure that the switch on the main power source has been ON for more than 12 hours, to warm the compressor oil by the crankcase heater.
- Pay attention to the following items while the system is running.
  - (a) Do not touch any of the parts by hand at the discharge gas side, since the compressor chamber and the pipes at the discharge side are heated higher than 90°C.
  - (b) DO NOT PUSH THE BUTTON OF THE MAGNETIC SWITCH (ES). It will cause a serious accident.

## 9. Safety and Control Device Setting

Indoor Unit

Model		PPFC-(2.0-6.0)UFA1NQ	
For Control Circuit Fuse Capacity		A	5
Freeze Protection Thermostat	Cut-Out	°C	0
	Cut-In	°C	14
Thermostat Differential		°C	2

## 10. Common

### 10.1 Field Minimum Wire Sizes for Power Source

#### WARNING

- Use the ELB(Electric Leakage Breaker) which is above medium reaction speed (residual-current circuit breaker, action time of 0.1s or less). Otherwise, it may lead to electric shock or fire.
- Run the cables through an appropriately sized conduit completely sealing the openings on either ends.

Field Minimum Wire Sizes for Power Source

Model	Power Source	Maximum Current (A)	Power Cord Size	Transmitting Cable Size
			IEC 60335-1 <sup>*1</sup>	IEC 60335-1 <sup>*1</sup>
PPFC-2.0UFA1NQ	220-240V ~50Hz	0.43	2.5mm <sup>2</sup>	0.75mm <sup>2</sup>
PPFC-2.5UFA1NQ		0.61		
PPFC-3.0UFA1NQ		0.56		
PPFC-4.0UFA1NQ		1.02		
PPFC-5.0UFA1NQ		1.02		
PPFC-6.0UFA1NQ		1.40		

#### NOTES:

- Follow local codes and regulations when selecting field wires.
- The wire sizes marked with \*1 in the above table are selected at the maximum current of the unit according to the European Standard, IEC 60335-1. Use the wires which are not lighter than the ordinary tough rubber sheathed flexible cord (code designation H05RR-F) or ordinary polychloroprene sheathed flexible cord (code designation H05RN-F) when get power from outside.

## 10. Common

- Use a shielded cable for the transmitting circuit and connect it to ground.
- In the case that power cables are connected in series, add each unit maximum current and select wires below.

Current i (A)	Wire Size (mm <sup>2</sup> )
$i \leq 6$	2.5
$6 < i \leq 10$	2.5
$10 < i \leq 16$	2.5
$16 < i \leq 25$	4
$25 < i \leq 32$	6
$32 < i \leq 40$	10
$40 < i \leq 63$	16
$63 < i$	※1

※1 In the case that current exceeds 63A, do not connect cables in series.

## 10.2 Setting of Dip Switches

### (1) Position of Dip Switches

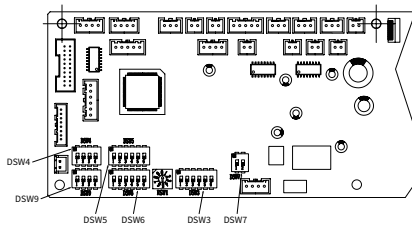

- (2) The PCB in the indoor unit is equipped with 1 rotary switch and 6 dip switches. Before testing the unit, set these dip switches according to the following instructions. These dip switches need to be set in order to operate the unit.

#### (a) Unit No. Setting, Low Air Volume Setting (DSW6)

Setting is required.

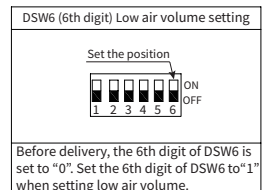
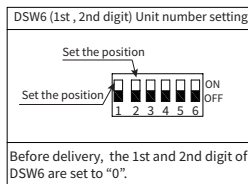

No.1 Unit	No.2 Unit	No.3 Unit	No.4 Unit
1 2 3 4 5 6 OFF	1 2 3 4 5 6 OFF	1 2 3 4 5 6 OFF	1 2 3 4 5 6 OFF

#### (b) Regional Identification(DSW6(4th digit), RWS1)

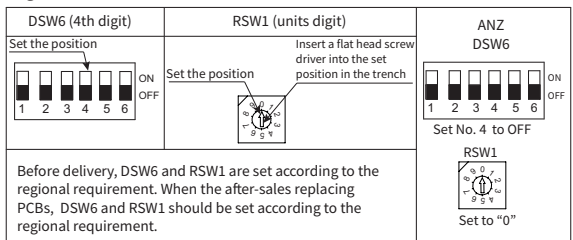

#### (c) Unit Mode Code Setting (DSW4)

No setting is required.

Setting the model code of the indoor unit.



(d) Capacity Code Setting (DSW3)

This dip switch is utilized for setting the capacity code which corresponds to the Horse Power of the indoor unit.

Factory setting:

DSW3

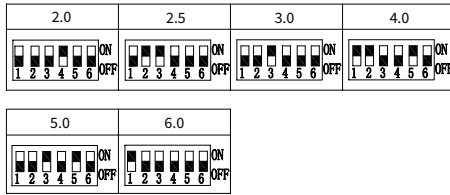

(e) Refrigerant Cycle No. Setting (DSW5)

Setting is required.

Factory setting:

DSW5 can be set from 0 to 63.

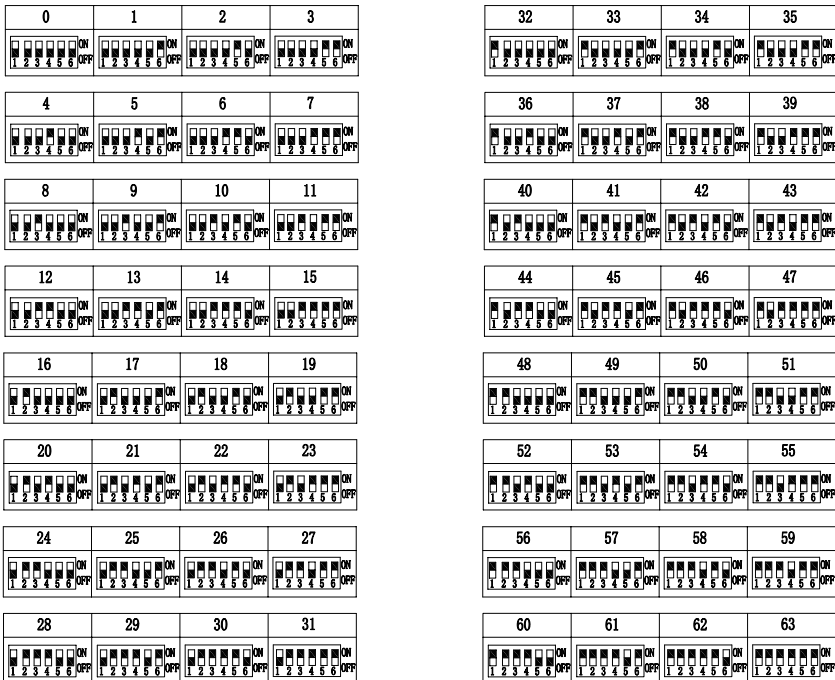
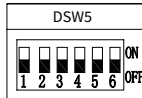

(f) Fuse Recover (DSW7)

No setting is required. Setting positions before shipment are all OFF.



NOTE:

- The “■” mark indicates position of dip switches. Figures show setting before shipment.



- Before setting dip switches, firstly turn OFF power source and set the position of the dip switches. If the switches are set without turning OFF the power source, the switch settings made are not recognized.

# Packing List

Item	Q'ty
Indoor Unit	1
Operation Installation and Maintenance Manual	1
Cardboard template	1
Washer with Insulation Material (M10)	4
Washer (M10)	4
Drain Hose	1
Hose Clamp	2
Clamp of Drain Pipe Connection	1
Drain Pipe Connection	1
Packing (10×T38×165)	1
Insulation (22ID)	1
Insulation (43ID)	1
Cord Clamp(small)	2
Cord Clamp(big)	7
Packing (5T×50×200)	1
Packing (5T×270×270)	1
Ring Core	1



1184168

## Hitachi-Johnson Controls Air Conditioning, Inc.

Add: 1-16-1, Kaigan Minato-ku, Tokyo, Japan

Specifications in this catalogue are subject to change without notice, in order that Hitachi-Johnson Controls may bring the latest innovations to customers.