

HITACHI

# OPERATION INSTALLATION & MAINTENANCE MANUAL

**air**Core 700  
SINGLE SPLIT  
INVERTER SERIES  
**INDOOR UNITS**

## MODELS

### 4-WAY CASSETTE TYPE

PCI-2.0UFA1NQ

PCI-2.5UFA1NQ

PCI-3.0UFA1NQ

PCI-4.0UFA1NQ

PCI-5.0UFA1NQ

PCI-6.0UFA1NQ

PCI-6.5UFA1NQ

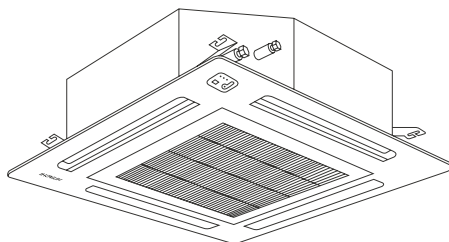

EN INSTRUCTION MANUAL

Scan the code to get the electronic manual.

Cooling & Heating

P02133Q

air



# IMPORTANT NOTICE

- Hitachi pursues a policy of continuous improvement in design and performance of products. The right is therefore reserved to vary specifications without notice.
- Hitachi cannot anticipate every possible circumstance that might involve a potential hazard.
- This heat pump air conditioner is designed for human comfort air conditioning only. Do not use this heat pump air conditioner for other purposes such as drying clothes, refrigerating foods or for any other cooling or heating purposes.
- The installer and system specialist shall ensure safety against leakage according to local regulations or standards. The following standards may be applicable if local regulations are not available. British Standard, BS4434 or Japan Standard, KHKS0010.
- No part of this manual may be reproduced without written permission.
- This manual should be considered as a permanent part of the air conditioning equipment and should remain with the air conditioning equipment.
- Signal words (DANGER, WARNING, CAUTION and NOTE) are used to identify levels of hazard seriousness. Definitions for identifying hazard levels are provided below with their respective signal words.



**DANGER** : **DANGER** indicates a hazardous situation which, if not avoided, will result in death or serious injury.



**WARNING** : **WARNING** indicates a hazardous situation that, if not avoided, could result in death or serious injury.

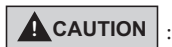

**CAUTION** : **CAUTION** indicates a hazardous situation which, if not avoided, could result in minor or moderate injury.

**NOTE** : **NOTE** is useful information for operation and/or maintenance.

- It is assumed that this heat pump air conditioner will be operated and serviced by persons conversant in English. If this is not the case, the distributor should add safety, caution and operating signs in the native language.
- If you have any questions, contact your distributor or dealer of Hitachi.
- This unit shall be installed in accordance with local codes and regulations.
- Do not install the unit in the following places. It may cause a fire, deformation, corrosion or failure.
  - Places where oil (including machinery oil) may be present in quantities.
  - Places where a lot of sulfide gas drifts such as in a hot spring.
  - Places where inflammable gas may generate or flow.
  - Places where strong salty wind blows such as coast regions.
  - Places with an atmosphere of acidity or alkalinity.
- This manual gives a common description and information for this heat pump air conditioner which you operate as well for other models.
- This system has been designed and tested to operate within the indoor temperature limits as stated below. The manufacturer cannot guarantee satisfactory performance if the unit is operated for prolonged periods outside of these limits.

(°C)

Temperature Range	Maximum	Minimum
Cooling Operation	32 DB / 23 WB	21 DB / 15 WB
Heating Operation	27 DB	20 DB

DB: Dry Bulb WB: Wet Bulb

## Correct Disposal of this product

This marking indicates that this product should not be disposed with other household wastes. To prevent possible harm to environment or human health from uncontrolled waste disposal, recycle it responsibly to promote the sustainable reuse of material resources. To return your used device, please use the return and collection systems or contact the retailer where the product was purchased. They can take this product for environmental safe recycling.



## **CHECKING PRODUCT RECEIVED**

- Upon receiving this product, inspect it for any shipping damage. Claims for damage, either apparent or concealed, should be filed immediately with the shipping company.
- Check the model number, electrical characteristics (power supply, voltage and frequency) and accessories to determine if they are correct.

The standard utilization of the unit shall be explained in these instructions. Therefore, the utilization of the unit other than those indicated in these instructions is not recommended. Please contact your local agent, as the occasion arises.

Hitachi's liability shall not cover defects arising from the alteration performed by a customer without Hitachi's consent in a written form.

# Table of Contents

1. Safety Summary .....	1
2. Name of Parts .....	10
3. Indoor Unit Installation .....	10
3.1 Unit Installation.....	11
4. Refrigerant Piping.....	14
4.1 Piping Connection.....	14
5. Drain Piping .....	15
5.1 General Information .....	15
5.2 Drain Pipe Connection .....	16
6. Electrical Wiring.....	17
6.1 General Information.....	17
6.2 Electrical Wiring Connection for Indoor Unit.....	18
6.3 Settings of Dip Switches .....	19
7. Remote Controller Operation .....	21
8. Installation of Optional Air Panel PHKF160PAQ1 .....	21
8.1 Factory-supplied Accessories .....	21
8.2 Installation.....	21
8.3 Wiring Connection for Air Panel.....	24
9. Maintenance .....	24
9.1 Take Out the Filter .....	24
9.2 Clean the Filter .....	25
9.3 Reset of Filter Indication.....	25
9.4 Safety and Control Device Setting.....	25

# 1. Safety Summary

No part of this publication may be reproduced, copied, filed or transmitted in any shape or form without the permission of Hitachi-Johnson Controls.

Within the policy of continuous improvement of its products, Hitachi-Johnson Controls reserves the right to make changes at any time without prior notification and without being compelled to introducing them into products subsequently sold. This document may therefore have been subject to amendments during the life of the product.

Hitachi makes every effort to offer correct, up-to-date documentation. Despite this, printing errors cannot be controlled by Hitachi and are not its responsibility.

As a result, some of the images or data used to illustrate this document may not refer to specific models. No claims will be accepted based on the data, illustrations and descriptions included in this manual. No type of modification must be made to the equipment without prior, written authorization from the manufacturer.

During normal air conditioning system design work or unit installation, greater attention must be paid in certain situations requiring particular care in order to avoid injuries and damage to the unit, the installation or the building or property.

Situations that jeopardize the safety of those in the surrounding area or that put the unit itself at risk will be clearly indicated in this manual.

To indicate these situations, a series of special symbols will be used to clearly identify these situations. Pay close attention to these symbols and to the messages following them, as your safety and that of others depend on it.



- Hitachi is not able to foresee all the circumstances which may result in a potential danger.
- Do not pour water in the indoor or outdoor unit. These products are fitted with electric components. If water comes into contact with electric components, it will cause a serious electric shock.
- Do not handle or adjust the safety devices inside the indoor and outdoor units. The handling or adjustment of these devices may result in serious accident.
- Do not open the service cover or access panel of the indoor and outdoor units without disconnecting the main supply.
- In the event of fire, switch off the mains, put out the fire immediately and contact your service supplier.
- Check that the earth cable is correctly connected.
- Connect the unit to a circuit breaker of the specified capacity, refer to “6.1 General Information” for details.
- The storage of equipment should be in accordance with the manufacturer's instructions.
- Do not install pipe work with diameters that are not specified for that model.
- Do not ground units to water pipes, gas pipes, telephone wires, or lightning rods as incomplete grounding can cause a severe shock hazard resulting in severe injury or death. Additionally, grounding to gas pipes could cause a gas leak and potential explosion causing severe injury or death.
- Do not install unit in an area where flammable materials are present due to risk of explosions that can cause serious injury or death.
- Safely dispose all packing and transportation materials in accordance with federal/state/local laws or ordinances. Packing materials such as nails and other metal or wood parts, including plastic packing materials used for transportation may cause injuries or death by suffocation.
- Refrigerant gas is heavier than air and replaces oxygen. A massive leak can lead to oxygen depletion, especially in basements, and an asphyxiation hazard could occur leading to serious injury or death.
- If refrigerant gas leaks during installation, ventilate the area immediately. Refrigerant gas may produce toxic gas if it comes into contact with fire. Exposure to this gas could cause severe injury or death.

### WARNING

- Only qualified personnel licensed or certified in their jurisdiction must carry out the installation work. Installation must be done in accordance with this installation manual. Improper installation may result in water leakage, electric shock, or fire.
- Pipe work and installation shall be in compliance with national codes (ASHRAE15 or IRC).
- Use only specified accessories and parts for installation work. Failure to use specified parts may result in water leakage, electric shock, fire, or the unit falling.
- Install the air conditioner or heat pump on a foundation strong enough that it can withstand the weight of the unit. A foundation of insufficient strength may result in the unit falling and causing injuries.
- Take into account strong winds, typhoons, or earthquakes when installing. Improper installation may result in the unit falling and causing accidents.
- Make sure that a separate power supply circuit is provided for this unit and that all electrical work is carried out by qualified personnel licensed or certified in their jurisdiction according to local, state, and national regulations. An insufficient power supply capacity or improper electrical construction may lead to electric shock or fire.
- Make sure that all wiring is secured, that specified wires are used, and that no external forces act on the terminal connections or wires. Improper connections or installation may result in fire.
- When wiring, position the wires so that the electrical wiring box cover can be securely fastened. Improper positioning of the electrical wiring box cover may result in electric shock, fire, or the terminals overheating.
- Before touching electrical parts, turn off the unit.
- The circuit must be protected with safety devices in accordance with local and national codes, i.e. a circuit breaker.
- Securely fasten the outdoor unit terminal cover (panel). If the terminal cover/panel is not installed properly, dust or water may enter the outdoor unit causing fire or electric shock.
- Do not use means to accelerate the defrosting process (if possible) or to clean, other than those recommended by the manufacturer.
- Assure that the maximum operating pressure is checked when connecting to Outdoor UNIT.
- This unit <PCI-UFA1NQ> is a PARTIAL UNIT AIR CONDITIONER, shall only be connected to an appliance suitable for the same refrigerant.
- This unit<PCI-UFA1NQ> is a PARTIAL UNIT AIR CONDITIONER, complying with PARTIAL UNIT requirements of IEC 60335-1 and IEC 60335-2-40, and must only be connected to other units that have been confirmed as complying to corresponding PARTIAL UNIT requirements of IEC 60335-1 and IEC 60335-2-40.
- System contains oversize protective earthing (grounding) terminal which shall be properly connected.
- When a fire occurs, cut off the power supply immediately.

### CAUTION

- Refrigerant leaks may hinder respiration as the gas displaces the air in the room. It is assumed that this heat pump air conditioner will be operated and serviced by English speaking people. If this is not the case, the customer should be added safely, caution and operating signs in the native language.
- Fit the indoor unit, the outdoor unit, the remote controller and the cable at a minimum of 3 meters away from sources of strong radiation from electromagnetic waves, such as medical equipment.
- Do not use sprays, such as insecticides, varnishes or enamels or any other inflammable gas within a meter of the system.
- If the circuit breaker or supply fuse of the unit comes on frequently, stop the system and contact the service supplier.
- Do not carry out maintenance or inspection work yourself. This work must be carried out by qualified service personnel with suitable tools and resources for the work.
- Do not place any foreign material (branches, sticks, etc.) in the air inlet or outlet of the unit. These units are fitted with high-speed fans and contact with any object is dangerous.

## 1. Safety Summary

---

- If the supply cord is damaged, it must be replaced by the manufacturer, its service agent or similarly qualified persons in order to avoid a hazard.
- Means for disconnection from the supply mains, which have a contact separation in all poles that provide full disconnection under overvoltage category III conditions, must be incorporated in the fixed wiring in accordance with AS/NZS 3000.
- The appliance shall be installed in accordance with national wiring regulations. The maximum working pressure is 4.15 MPa. This maximum working pressure shall be considered when connecting the indoor unit to outdoor unit.
- Do not touch the switch with wet fingers. Touching a switch with wet fingers can cause electric shock.
- This appliance can be used by children aged from 8 years and above and persons with reduced physical, sensory or mental capabilities or lack of experience and knowledge if they have been given supervision or instruction concerning use of the appliance in a safe way and understand the hazards involved. Cleaning and user maintenance shall not be made by children without supervision.
- Wear adequate personal protective equipment (protective gloves, safety glasses,...) when installing, maintaining or servicing the system.
- The heat exchanger fins are sharp enough to cut. To avoid injury, wear gloves or cover the fins while working around them.
- Do not touch the refrigerant pipes during and immediately after operation as the refrigerant pipes may be hot or cold, depending on the condition of the refrigerant flowing through the refrigerant piping, compressor, and other refrigerant cycle parts. Your hands may suffer burns or frostbite if you touch the refrigerant pipes. To avoid injury, give the pipes time to return to normal temperature or, if you must touch them, be sure to wear proper gloves.
- Install drain piping to ensure proper drainage. Improper drain piping may result in water leakage and property damage.
- Insulate piping to prevent condensation.
- Be careful when transporting the product.
- Do not install the air conditioner or heat pump in the following locations:
  - Where a mineral oil mist or oil spray or vapor is produced, for example, in a kitchen. Plastic parts may deteriorate and fall off or result in water leakage.
  - Where corrosive gas, such as sulfurous acid gas, is produced. Corroding copper pipes or soldered parts may result in refrigerant leakage.
  - Near machinery emitting electromagnetic waves. Electromagnetic waves may disturb the operation of the control system and cause the unit to malfunction.
  - Where flammable gas may leak, where there is carbon fiber, or ignitable dust suspension in the air, or where volatile flammables such as thinner or gasoline are handled. Operating the unit in such conditions can cause a fire.
- Take adequate measures to prevent the outdoor unit from being used as a shelter by small animals. Small animals making contact with electrical parts can cause malfunctions, smoke, or fire. Instruct the user to keep the area around the unit clean.
- Servicing shall be performed only as recommended by the manufacturer and licensed or certified in their jurisdiction.
- This air conditioner has been designed for standard air conditioning for human beings. For use in other applications, please contact your Hitachi dealer or service contractor.
- The air conditioning system should only be installed by qualified personnel, with the necessary resources, tools and equipment, who are familiar with the safety procedures required to successfully carry out the installation.
- PLEASE READ THE MANUAL AND THE FILES ON THE CD-ROM CAREFULLY BEFORE STARTING WORK ON THE INSTALLATION OF THE AIR CONDITIONING SYSTEM.
- Failure to observe the instructions for installation, use and operation described in this documentation may result in operating failure including potentially serious faults or even the destruction of the air conditioning system.
- It is assumed that the air conditioning system will be installed and maintained by responsible personnel trained for the purpose. If this is not the case, the customer should include all the safety, caution and operating signs in the native language of the personnel responsible.







- Do not install the unit in places where silicon gas is present. Any silicon gas deposited on the surface of the heat exchanger will repel water. As a result, the condensate water will splash out of the collection tray and into the electrical box. Water leaks or electrical faults may eventually be caused.
- Do not install the unit in a place where the current of expelled air directly affects animals or plants as they could be adversely affected.
- This appliance is not intended for use by persons (including children) with reduced physical, sensory or mental capabilities, or lack of experience and knowledge, unless they have been given supervision or instruction concerning use of the appliance by a person responsible for their safety. Children should be supervised to ensure that they do not play with the appliance.

### NOTES:

- The air in the room should be renewed and the room ventilated every 3 or 4 hours.
- The indoor unit should be positioned where the unit and interunit wires (outdoor to indoor) are at least 3.3ft (1m) away from any televisions or radios. (The unit may cause interference with the picture or sound.) Depending on the radio waves, a distance of 3.3ft (1m) may not be sufficient to eliminate the noise.
- Dismantling the unit, treatment of the refrigerant, oil and additional parts must be done in accordance with the relevant local, state, and national regulations.
- As maximum allowable pressure is 4.15MPa, minimum allowable pressure is 2.21MPa, the wall thickness of field-installed pipes should be selected in accordance with the relevant local, state, and national regulations.

### Explanation of symbols displayed on the indoor unit or outdoor unit

	<b>WARNING</b>	These symbols show that appliance uses a flammable refrigerant. If the refrigerant is leaked and exposed to an external ignition source, there is a risk of fire.
		
	<b>CAUTION</b>	This symbol shows that the operation manual should be read carefully.
	<b>CAUTION</b>	This symbol shows that a service personnel should be handling this equipment with reference to the installation manual.
	<b>CAUTION</b>	This symbol shows that information is available such as the operating manual or installation manual.

## Precuations for R32

**This air conditioner uses R32 flammable refrigerant.** Air conditioner with R32 refrigerant, if not be treated carefully, may cause serious harm to the human body or surrounding things. Please read the following instructions carefully before installing, using and maintaining.

### **WARNING**

- Do not use means to accelerate the defrosting process or to clean, other than those recommended by the manufacturer.
- The appliance shall be stored in a room without continuously operating ignition sources (for example: open flames, an operating gas appliance or an operating electric heater).
- Do not pierce or burn the refrigerant system to avoid the leakage.
- Be aware that refrigerants might not contain an odour.
- Do not charge R32 into system other than those designated for R32.  
Do not charge R32 system with oil other than those designated for R32.
- Do not use a reclaim cylinder other than an R32 reclaim cylinder.
- Be sure to only use refrigerant piping approved for use with R32 refrigerant. The use of unapproved piping may result in explosive rupture.
- The pipe-work shall be securely mounted and guarded from physical damage.
- The national gas regulations shall also be observed when field-installed refrigerant pipes are

## 1. Safety Summary

---

required.

- Field-made refrigerant joints indoors shall be tightness tested. The test method shall have a sensitivity of 5 grams per year of refrigerant or better under a pressure of at least 0,25 times the maximum allowable pressure. No leak shall be detected; Mechanical connections shall be accessible for maintenance purposes.
- The joints shall not be reused, unless after re-flaring the pipe.
- Joints made in the installation between parts of the refrigerating system, with outdoor part charged, shall be made in accordance with the following.
  - A brazed, welded, or mechanical connection shall be made before opening the valves to permit refrigerant to flow between the refrigerating system parts. A vacuum valve shall be provided to evacuate the interconnecting pipe and/or any uncharged refrigerating system part.
  - Mechanical connectors used indoors shall comply with ISO 14903. When mechanical connectors are reused indoors, sealing parts shall be renewed. When flared joints are reused indoors, the flare part shall be re-fabricated.
  - Refrigerant tubing shall be protected or enclosed to avoid damage.
- That after completion of field piping for split systems, the field pipework shall be pressure tested with an inert gas and then vacuum tested prior to refrigerant charging, according to the following requirements:
  - The minimum test pressure for the low side of the system shall be the low side design pressure and the minimum test pressure for the high side of the system shall be the high side design pressure, unless the high side of the system, cannot be isolated from the low side of the system in which case the entire system shall be pressure tested to the low side design pressure.
- The appliance shall be stored in a well-ventilated area where the room size corresponds to the room area as specified.
- The appliances are designed for use at altitudes less than 2000m, may cause serious harm to the human body or surrounding things if used at altitudes 2000m and above.
- Keep any required ventilation openings clear of obstruction, don't block air inlet or air outlet, Otherwise, the cooling or heating capacity will be weakened, even cause system stop operating or safety hazard.
- Maintenance or repair of air conditioner using R32 refrigerant must be carried out after security check to minimize risk of incidents.
- Ensure no following objects under the indoor unit:
  - Microwaves, ovens and other hot objects.
  - Computers and other high electrostatic appliances.
  - Sockets that plug frequently.
- Installation, maintenance, service, repairing, removing and disposal operations, shall only be performed by the qualified personnel or recommended by the manufacturer.
- Every working procedure that affects safety means shall only be carried out by competent persons. Examples for such working procedures are:
  - breaking into the refrigerating circuit;
  - opening of sealed components;
  - opening of ventilated enclosures.
- Precautions shall be taken to avoid excessive vibration or pulsation to refrigerating piping for the transport and installation.
- Protection devices, piping and fittings shall be protected as far as possible against adverse environmental effects, for example the danger of water collecting and freezing in relief pipes or the accumulation of dirt and debris.
- When installing or repairing the air conditioner and the connecting line is not long enough, the entire connecting line shall be replaced with the connecting line of the original specification; extension is not allowed.
- Refrigerating systems shall be so installed as to minimize the likelihood of hydraulic shock damaging the system.
- The appliance shall be stored and installed so as to prevent mechanical damage from occurring.
- Work shall be undertaken under a controlled procedure so as to minimise the risk of a flammable gas

or vapour being present while the work is being performed.

- All maintenance staff and others working in the local area shall be instructed on the nature of work being carried out. Work in confined spaces shall be avoided.
- The area shall be checked with an appropriate refrigerant detector prior to and during work, to ensure the non-existence of potentially toxic or flammable atmospheres. Ensure that the leak detection equipment being used is suitable for use with all applicable refrigerants, i.e. nonsparking, adequately sealed or intrinsically safe.
- If any hot work is to be conducted on the refrigerating equipment or any associated parts, appropriate fire extinguishing equipment shall be available to hand. Have a dry powder or CO<sub>2</sub> fire extinguisher adjacent to the charging area.
- No person carrying out work in relation to a refrigerating system which involves exposing any pipe work shall use any sources of ignition in such a manner that it can lead to the risk of fire or explosion. All possible ignition sources, including cigarette smoking, should be kept sufficiently far away from the site of installation, repairing, removing and disposal, during which refrigerant can possibly be released to the surrounding space. Prior to work taking place, the area around the equipment is to be surveyed to make sure that there are no flammable hazards or ignition risks. "No Smoking" signs shall be displayed.
- Ensure that the area is in the open or that it is adequately ventilated before breaking into the system or conducting any hot work. A degree of ventilation shall continue during the period that the work is carried out. The ventilation should safely disperse any released refrigerant and preferably expel it externally into the atmosphere.
- Anti-static precautions is necessary for installing and maintenance, for example, wear pure cotton clothes and gloves.
- If R32 refrigerant leakage occurs during the installation, operators shall immediately detect the concentration in indoor environment until it reaches a safe level. If the leakage affects the performance of the machine, please immediately stop the operation, and the air conditioner must be vacuumed firstly and be returned to the maintenance station for processing.
- Where electrical components are being changed, they shall be fit for the purpose and to the correct specification. At all times the maintenance and service guidelines of this manual shall be followed. If in doubt, consult the manufacturer's technical department for assistance. The following checks shall be applied to installations using R32:
  - The refrigerant charge is in accordance with the room size within which the refrigerant containing parts are installed.
  - The ventilation machinery and inlets and outlets are operating adequately and are not obstructed; and shall keep away from heat source, inflammable or explosive conditions.
  - Marking to the equipment continues to be visible and legible. Markings and signs that are illegible shall be corrected.
  - Refrigerating pipe or components are installed in a position where they are unlikely to be exposed to any substance which can corrode refrigerant containing components, unless the components are constructed of materials which are inherently resistant to being corroded or are suitably protected against being so corroded.
- Repair and maintenance to electrical components shall include initial safety checks and component inspection procedures. If a fault exists that could compromise safety, then no electrical supply shall be connected to the circuit until it is satisfactorily dealt with. If the fault cannot be corrected immediately but it is necessary to continue operation, an adequate temporary solution shall be used. This shall be reported to the owner of the equipment so all parties are advised. Initial safety checks shall include:
  - that capacitors are discharged: this shall be done in a safe manner to avoid possibility of sparking.
  - that no live electrical components and wiring are exposed while charging, recovering or purging the system.
  - that there is continuity of earth bonding.
- Sealed electrical components shall not be repaired.
- Check that cabling will not be subject to wear, corrosion, excessive pressure, vibration, sharp edges or any other adverse environmental effects. The check shall also take into account the effects of

## 1. Safety Summary

---

aging or continual vibration from sources such as compressors or fans.

- Under no circumstances shall potential sources of ignition be used in the searching for or detection of refrigerant leaks. A halide torch (or any other detector using a naked flame) shall not be used.
- Air-tightness test shall be carried out as guaranteed. Charging oxygen, acetylene or other inflammable and toxic gases during leakage inspection and air-tightness test may lead to explosions. It recommended to use nitrogen gas for this test.
- The following leak detection methods are deemed acceptable for all refrigerant systems.
  - Electronic leak detectors may be used to detect refrigerant leaks but, in the case of flammable refrigerants, the sensitivity can be inadequate, or can need re-calibration. (Detection equipment shall be calibrated in a refrigerant-free area.) Ensure that the detector is not a potential source of ignition and is suitable for the refrigerant used. Leak detection equipment shall be set at a percentage of the LFL of the refrigerant and shall be calibrated to the refrigerant employed, and the appropriate percentage of gas (no more than 25 %) is confirmed.
  - The fluid used in leak detection is applicable to most refrigerants. But do not use chloride solvents to prevent the reaction between chlorine and refrigerants and the corrosion of copper pipeline.
  - If a leak is suspected, all naked flames shall be removed/extinguished.
  - If a leakage of refrigerant is found which requires brazing, all of the refrigerant shall be recovered from the system, or isolated in a part of the system remote from the leak. Removal of refrigerant shall be according to this manual.
- When breaking into the refrigerant circuit to make repairs – or for any other purpose – conventional procedures shall be used. However, for flammable refrigerants it is important that best practice is followed since flammability is a consideration. The following procedure shall be adhered to:
  - safely remove refrigerant following local and national regulations;
  - evacuate;
  - purge the circuit with inert gas;
  - continuously flush with inert gas when using flame to open circuit;
  - open the circuit.
- The refrigerant charge shall be recovered into the correct recovery cylinders.
- Purging of the refrigerant circuit shall be achieved by breaking the vacuum in the system with inert gas and continuing to fill until the working pressure is achieved, then venting to atmosphere, and finally pulling down to a vacuum. This process shall be repeated until no refrigerant is within the system. The system shall be vented down to atmospheric pressure to enable work to take place.
- Ensure that the outlet of the vacuum pump is not close to any potential ignition sources and that ventilation is available.
- In addition to conventional charging procedures, the following requirements shall be followed.
  - Ensure that contamination of different refrigerants does not occur when using charging equipment. Hoses or lines shall be as short as possible to minimise the amount of refrigerant contained in them.
  - Cylinders shall be kept in an appropriate position according to the instructions.
  - Ensure that the refrigerating system is earthed prior to charging the system with refrigerant.
  - Label the system when charging is complete (if not already labelled).
  - Extreme care shall be taken not to overfill the refrigerating system.
- Prior to recharging the system, it shall be pressure-tested with the appropriate purging gas. The system shall be leak-tested on completion of charging but prior to commissioning. A follow up leak test shall be carried out prior to leaving the site.
- Before carrying out the decommissioning procedure, it is essential that the technician is completely familiar with the equipment and all its detail. It is recommended good practice that all refrigerants are recovered safely. Prior to the task being carried out, an oil and refrigerant sample shall be taken in case analysis is required prior to re-use of recovered refrigerant. It is essential that electrical power is available before the task is commenced.
  - Become familiar with the equipment and its operation.
  - Isolate system electrically.
  - Before attempting the procedure, ensure that:
    - (a) mechanical handling equipment is available, if required, for handling refrigerant cylinders;
    - (b) all personal protective equipment is available and being used correctly;

- (c) the recovery process is supervised at all times by a competent person;
- (d) recovery equipment and cylinders conform to the appropriate standards.
- Pump down refrigerant system, if possible.
- If a vacuum is not possible, make a manifold so that refrigerant can be removed from various parts of the system.
- Make sure that the cylinder is situated on the scales before recovery takes place.
- Start the recovery machine and operate in accordance with instructions.
- Do not overfill cylinders (no more than 80% volume liquid charge).
- Do not exceed the maximum working pressure of the cylinder, even temporarily.
- When the cylinders have been filled correctly and the process completed, make sure that the cylinders and the equipment are removed from site promptly and all isolation valves on the equipment are closed off.
- Recovered refrigerant shall not be charged into another refrigerating system unless it has been cleaned and checked.
- Equipment shall be labelled stating that it has been de-commissioned and emptied of refrigerant. The label shall be dated and signed. For appliances containing flammable refrigerants, ensure that there are labels on the equipment stating the equipment contains flammable refrigerant.
- When removing refrigerant from a system, either for servicing or decommissioning, it is required to follow good practice so that all refrigerants are removed safely.
- When transferring refrigerant into cylinders, ensure that only appropriate refrigerant recovery cylinders are employed. Ensure that the correct number of cylinders for holding the total system charge is available. All cylinders to be used are designated for the recovered refrigerant and labelled for that refrigerant (i.e. special cylinders for the recovery of refrigerant). Cylinders shall be complete with pressure-relief valve and associated shut-off valves in good working order. Empty recovery cylinders are evacuated and, if possible, cooled before recovery occurs.
- The recovery equipment shall be in good working order with a set of instructions concerning the equipment that is at hand and shall be suitable for the recovery of the flammable refrigerant. Consult manufacturer if in doubt. In addition, a set of calibrated weighing scales shall be available and in good working order. Hoses shall be complete with leak-free disconnect couplings and in good condition.
- The recovered refrigerant shall be processed according to local legislation in the correct recovery cylinder, and the relevant waste transfer note arranged. Do not mix refrigerants in recovery units and especially not in cylinders.
- If compressors or compressor oils are to be removed, ensure that they have been evacuated to an acceptable level to make certain that flammable refrigerant does not remain within the lubricant. The compressor body shall not be heated by an open flame or other ignition sources to accelerate this process. Draining of oil from a system shall be carried out safely.
- Disposal of equipment shall follow the national regulations.
- The storage of the appliance should be in accordance with the applicable regulations or instructions, whichever is more stringent.
- The maximum number of pieces of equipment permitted to be stored together notes by each product package information and standard follows ISO 780-2015.
- After completing the installation work, check that the refrigerant gas does not leak throughout the system.
- When installing the unit in a small room, take measures to keep the refrigerant concentration from exceeding allowable safety limits. Excessive refrigerant leaks, in the event of an accident in a closed ambient space, can lead to oxygen deficiency.
- When installing or relocating the air conditioner, do not let any other substances besides R32, such as air, enter the refrigerant circuit. The presence of air or foreign matter in the refrigerant circuit causes an abnormal pressure rise, which may result in equipment damage and even injury.
- Refrigerant R32 in the system must be kept clean, dry, and tight.
  - Clean and Dry -- Foreign materials (including mineral oils such as SUNISO oil or moisture) should be prevented from getting into the system.
  - Tight -- R32 does not contain any chlorine, does not destroy the ozone layer, and does not reduce the earth's protection against harmful ultraviolet radiation. R32 can contribute to the greenhouse effect if it is released.

## 1. Safety Summary

- Only use tools for R32, such as a gauge manifold, charge hose, gas leak detector, reverse flow check valve, refrigerant charge base, vacuum gauge, or refrigerant recovery equipment.
- If the conventional refrigerant and refrigerator oil are mixed in R32, the refrigerant may deteriorate.
- Appliance shall be installed, operated and stored in a room with a floor area larger than  $A_{min}(m^2)$  [ $A_{min}(m^2)$  - see table below].
- The installation of pipe-work shall be kept to a room with a floor area larger than  $A_{min}(m^2)$  [ $A_{min}(m^2)$  - see table below].
- The unit has requirements on the minimum required room area ( $A_{min}$ ) used with different refrigerant charging amount (m). The total amount of refrigerant charged in the system corresponds to the room area installed in the table below. The calculation result is based on the cassette-mounted unit, and the installation height is no less than 2.2m.

Minimum required room area for each refrigerant amount charged

4-Way Cassette (for single room)					
Installation Height: 2.2m					
m(kg)	$A_{min}(m^2)$	m(kg)	$A_{min}(m^2)$	m(kg)	$A_{min}(m^2)$
≤1.842	-	2.80	8.291	4.00	11.845
1.843	5.458	3.00	8.884	4.20	12.437
2.00	5.922	3.20	9.476	4.40	13.029
2.20	6.515	3.40	10.068	4.60	13.622
2.40	7.107	3.60	10.660	4.80	14.585
2.60	7.699	3.80	11.253	5.00	15.826

## 2. Name of Parts

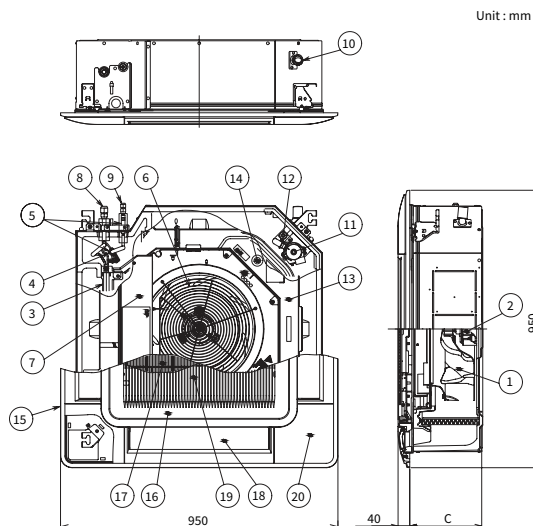

Item.	Part Name	
1	Fan	
2	Fan Motor	
3	Heat Exchanger	
4	Distributor	
5	Strainer	
6	Protective Cover(PCI(4.0-6.5) only)	
7	Electrical Box	
8	Refrigerant Gas Pipe Connection	
9	Refrigerant Liquid Pipe Connection	
10	Drain Pipe Connection	
11	Drain Discharge Mechanism	
12	Float Switch	
13	Drain Pan	
14	Rubber Plug for Drain	
15	Air Panel PHKF160PAQ1	
16	Air Inlet Grille	
17	Air Filter	
18	Air Outlet	
19	Air Inlet	
20	Cover for Corner Pocket	
C	PCI(2.0-3.0):238	PCI(4.0-6.5):288

## 3. Indoor Unit Installation

**⚠ DANGER**

- Check to ensure that the accessories are packed with the indoor unit.
- Do not install the indoor units outdoors. If installed outdoors, an electric hazard or electric leakage will occur.
- Consider the air distribution from each indoor unit to the space of the room, and select a suitable location so that uniform air temperature in the room can be obtained. The unit must not be installed below 2.5 meters from the floor level, with a recommend installation height between 2.5 and 3 meters. If the unit is installed higher than 3 meters, it is also recommended that a fan be utilized to obtain uniform air temperature in the room.
- Avoid obstacles which may hamper the air intake or the air discharge flow.
- Pay attention to the following points when the indoor units are installed in a hospital or other places where there are electronic waves from medical equipment, etc.
- Do not install the indoor units where electromagnetic wave is directly radiated to the electrical box, remote control cable or remote control switch.
- Prepare a steel box and install the remote control switch in it. Prepare a steel conduit tube and wire the remote control cable in it. Then connect the ground wire with the box and tube.
- Install a noise filter when the power supply emits harmful noises.
- This unit is exclusive nonelectrical heater type indoor unit. It is prohibited to install an electrical heater in the field.
- Do not put any foreign material into the indoor unit and check to ensure that none exist in the indoor unit before the installation and test running. Otherwise, a fire or failure, etc., may occur.

**⚠ CAUTION**

- Do not install the indoor units in a flammable environment to avoid a fire or an explosion.
- Do not install the indoor unit in the laundry.

### 3. Indoor Unit Installation

- Check to ensure that the ceiling slab is strong enough. If not strong enough, the indoor unit may fall down on you.
- Do not install the indoor units in a machinery shop or kitchen where vapor from oil or mist flows to the indoor units. The oil will deposit on the heat exchanger, thereby reducing the indoor unit performance, and may deform. In the worst case, the oil damages the plastic parts of the indoor unit.
- To avoid any corrosive action to the heat exchangers, do not install the indoor units in an acid or alkaline environment.
- When lifting or moving the indoor unit, use appropriate slings to avoid damage and be careful not to damage the insulation material on units' surface.

## 3.1 Unit Installation

### 3.1.1 Factory-supplied Accessories

Accessory		Qty.	Purpose
Washer with insulation material (M10)		4	For unit installation
Washer (M10)		4	
Drain hose		1	For drain hose connection
Hose clamp		1	
Ring core		1	For anti-electromagnetic interference of transmission cables between outdoor and indoor units
Wire clamp		1	For fixing wirings (only in PCI 2.0 / 2.5/ 3.0UFA1NQ)
Wire Harness		1	For human sensor panel installation, connected on CN33 port of main board

Accessory		Qty.	Purpose
Pipe insulation		1	For refrigerant piping connection
Pipe insulation		1	
Cord clamp		2	For fixing remote control switch wiring, louver sensor and insulation of piping
Cord clamp		7	
Insulation (5Tx 50 x200)		1	For covering wiring connection
Insulation (5Tx 270 x270)		1	For covering drain connection
Screw (M4x10)		2	For fixing wire clamps(only in PCI 2.0 / 2.5/ 3.0UFA1NQ)

### 3.1.2 Initial Check

1. Install the indoor unit with a proper clearance around it. Pay careful attention of installation direction for the piping, wiring and maintenance working space as shown below.
2. Provide a service access door near the unit piping connection area on the ceiling.

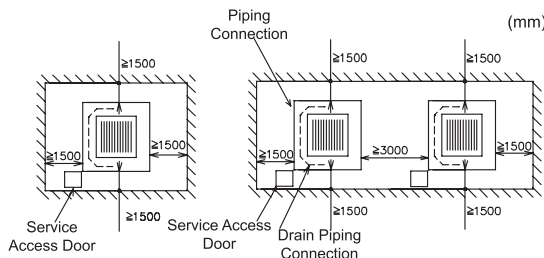



- Check space between ceiling and false ceiling is enough as indicated below.
- Check the ceiling surface is flat for the air panel installation work.

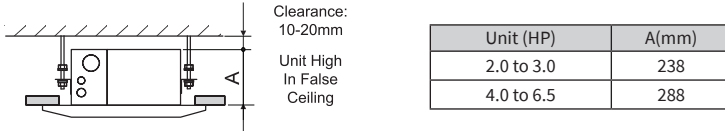

- Check down slope Pitch of Drain Piping is following the specifications indicated in chapter “5. Drain Piping”.

#### Opening of false ceiling

- Cut out the area for the indoor unit in the false ceiling and install suspension bolts, as shown below.

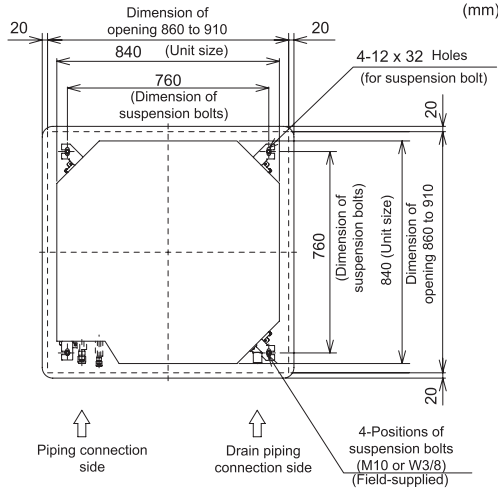

- Check to ensure that the ceiling is horizontally level, otherwise water can not flow.
- Strengthen the opening parts of the false ceiling.

### 3.1.3 Installation

#### Mounting of suspension bolts

- Mount suspension bolts using M10 (W3/8) as size, as shown.

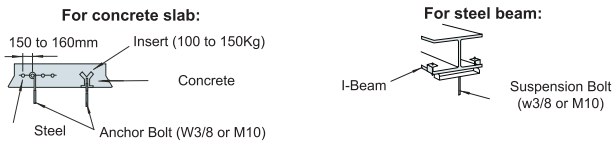

#### Mounting of indoor unit

- Mount the nuts and the washers to the suspension bolts. Put the washer so that the surface with insulation can face downwards as shown below.

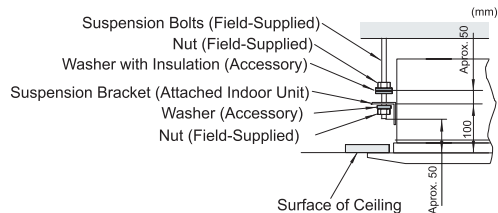

### 3. Indoor Unit Installation

- Consider piping connection side before lifting indoor unit.
- Lift the indoor unit by hoist and do not put any force on the drain pan.
- Secure the indoor unit using the nuts and washers.

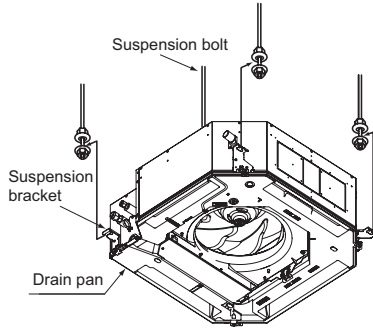

**NOTES:**

- If a false ceiling has already been installed, complete all piping and wiring work inside the ceiling before hooking-up the indoor unit.
- Secure the indoor unit using the nuts, and flat washers.

**Adjusting of space between indoor units and false ceiling opening**

Adjust the indoor unit to the correct position while checking with the pattern for installation.

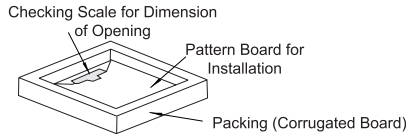

**For ceiling already completed with panels**

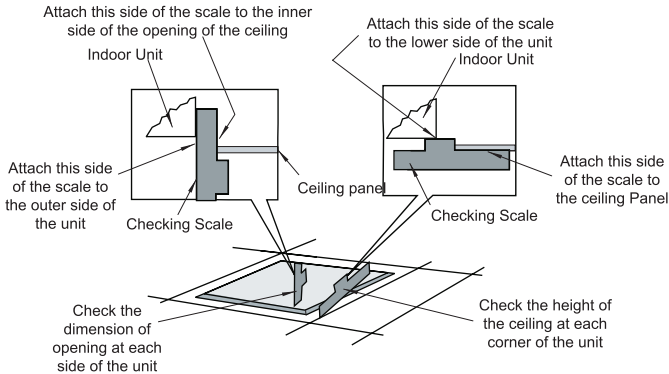

**Ceiling not completed with panels yet**

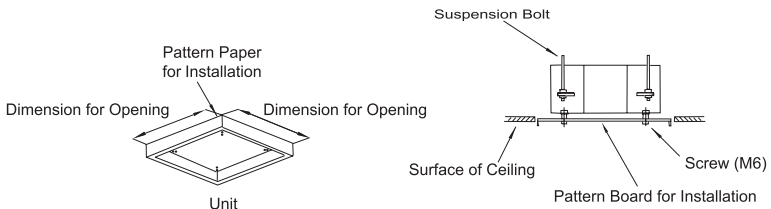

Tighten the nuts of the suspension brackets after the adjustment is completed. Apply LOCK-TIGHT paint to the bolts and nuts in order to prevent them from loosening. If not done, abnormal noises or sounds may occur and the indoor unit may come loose.

# 4. Refrigerant Piping

## 4.1 Piping Connection

### 4.1.1 Piping Positions

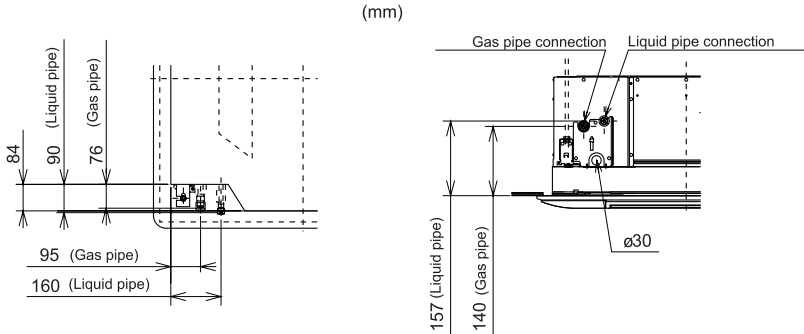

### 4.1.2 Size of Piping Connection

#### Piping size

Model	Liquid piping (mm(in.))	Gas piping(mm(in.))
PCI-2.0 to 3.0UFA1NQ	φ 6.35 (1/4)	φ 12.70 (1/2)
PCI-4.0 to 6.5UFA1NQ	φ 9.52 (3/8)	φ 15.88 (5/8)

#### Thickness of copper pipes

φ (in)	φ (mm)	Thickness (mm)
1/4	6.35	0.80
3/8	9.53	0.80
1/2	12.70	0.80
5/8	15.88	1.00

#### Flare Pipe Dimensions

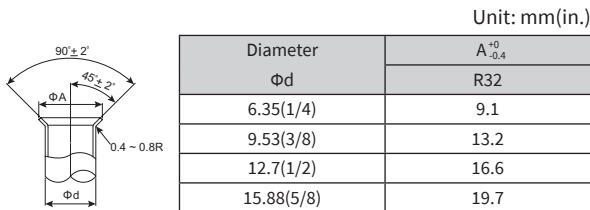

#### Flare Nut Dimensions

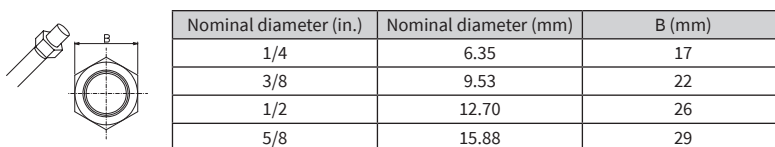

# 5. Drain Piping

## 5.1 General Information

### INCORRECT

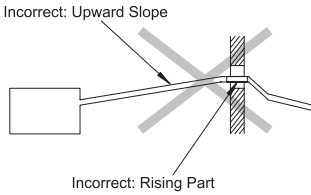

### CORRECT

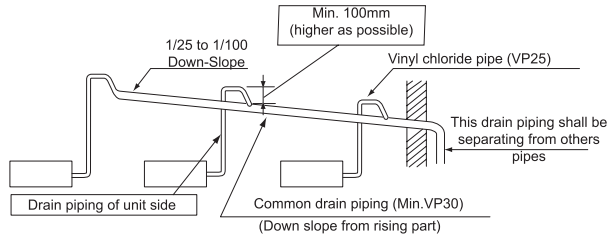

### CAUTION

- Do not create an upper-slope or rise for the drain piping, since drain water will flow back to the unit and leakage to the room will occur when the unit operation is stopped.
- Do not connect the drain pipe with sanitary or sewage piping or any other drainage piping.
- When the common drain piping is connected with other indoor units, the connected position of each indoor unit must be higher than the common piping. The pipe size of the common drain pipe must be large enough according to the unit size and number of unit.
- Drain piping will require insulating if the drain is installed in a location where condensation forming on the outside of drain pipe may drop and cause damage. The insulation for the drain pipe must be selected to insure vapor sealing and prevent condensation forming.
- Drain trap should be installed next to indoor unit. This trap must be designed to good practice and be checked with water (charged) and tested for correct flow. Do not tie or clamp the drain pipe and refrigerant pipe together.

### NOTES:

- Install drainage in accordance with national and local codes.
- After performing drain piping work and electrical wiring, check to ensure that the water flows smoothly as in the following procedure.

### Checking with drain-up mechanism and float switch

- Switch ON the power supply.
- Pour approximately 2.0 to 2.5 liters of water gradually into the drain pan, then float switch up and drain pump start working automatically.
- Check to ensure that the water flows smoothly inside the transparent drain pipe connection whether no water leakage occurs. When water cannot be found at the end of the drain piping, pour more water smoothly into the drain pan.
- If the water overflows from the drain pan, recheck the drain piping.
- Switch OFF the power supply after.

### NOTE:

- Pay attention to the thickness of the insulation when the left side piping is performed. If it is too thick, piping can not be installed in the unit.

## 5.2 Drain Pipe Connection

1. The position of the drain pipe connection is shown below.

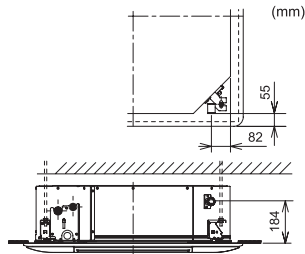

2. Prepare a polyvinyl chloride pipe with a 32mm outer diameter.

3. Fasten the tubing to the drain hose with an adhesive and the factory-supplied clamp.

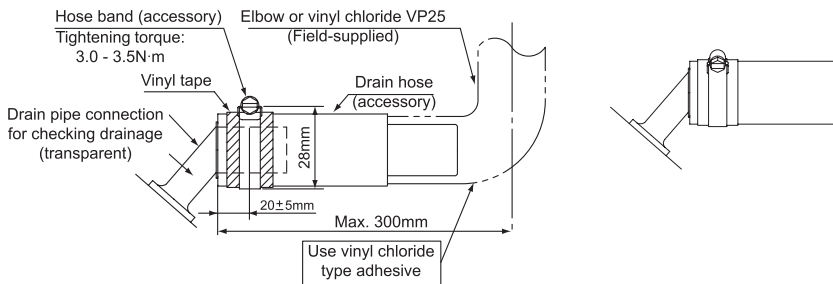

4. The drain piping must be performed with a down-slope pitch of 1/25 to 1/100.

5.  $a+b+c \leq 1100\text{mm}$ .

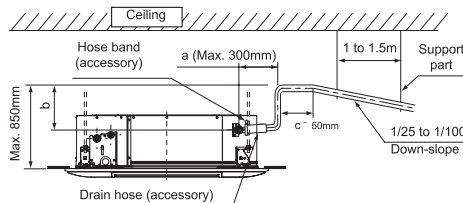

6. Do not apply excessive force to the Drain Pipe connection. It could cause a damage.

7. Do not use a bent or twisted Drain Hose, it will cause water leakage.

8. Insulate the drain pipe after connecting the drain hose.

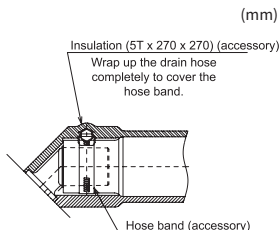

### NOTE:

- If there is excessive clearance between the drain pipe connection and the drain hose, add a sealing material between both parts in order to fit and not deform the drain hose.

## 6. Electrical Wiring

### 6.1 General Information



- Turn OFF the main power switch to the indoor unit and the outdoor unit and wait for more than 10 minutes before electrical wiring work or a periodical check is performed.
- Check to ensure that the indoor fan and the outdoor fan have stopped before electrical wiring work or a periodical check is performed.
- Protect the wires, drain pipe, electrical parts, etc. from rats or other small animals. If not protected, rats may gnaw at unprotected parts and at the worst, a fire will occur.
- The ground wire must be longer than the current-carrying conductor when installing the power cord.
- Using the air conditioner power terminal to transfer the power cord is strictly prohibited. A power distribution box can be used to expand the power distribution on the indoor unit.
- A switch that can ensure all-pole disconnection should be installed between the power supply and air conditioning unit, and the contact spacing of this switch should be no less than 3mm.



- Use the ELB(Electric Leakage Breaker) which is above medium reaction speed (residual-current circuit breaker, action time of 0.1s or less). Otherwise, it may lead to electric shock or fire.
- Use twisted shielded pair cable or shield pair cable for transmission cables between the indoor and the outdoor units, and connect the shielded part to the earth screw in the electrical box of the indoor unit as shown below.
- Wrap the field-supplied insulation around the wires, and plug the wiring connection hole with the seal material to protect the product from any condensate water or insects.
- Tightly secure the wires with the cord clamp inside the indoor unit.
- Lead the wires through the knockout hole in the side cover when using conduit.
- Secure the cable of the remote control switch using the cord clamp inside the electrical box.

#### General check

1. Make sure that the field-selected electrical components (main power switches, circuit breakers, wires, conduit connectors and wire terminals) have been properly selected. Make sure that the components follow local codes and regulations.
2. Check to ensure that the power supply voltage is within  $\pm 10\%$  of the rated voltage.
3. Check the capacity of the electrical wires. If the power source capacity is too low, the system cannot be started due to the voltage drop.
4. Select the wire sizes according to the European Standard IEC 60335-1. Use the wires which are not lighter than the ordinary tough rubber sheathed flexible cord (code designation H05RR-F) or ordinary polychloroprene sheathed flexible cord (code designation H05RN-F) when get power from outside.

Field Minimum Wire Sizes for Power Source

Model	Power Source	Maximum Current (A)	Power Cord Size	Transmitting Cable Size
			IEC 60335-1	IEC 60335-1
PCI-2.0UFA1NQ	220-240V ~50Hz	0.39	2.5mm <sup>2</sup>	0.75mm <sup>2</sup>
PCI-2.5UFA1NQ		0.39		
PCI-3.0UFA1NQ		0.48		
PCI-4.0UFA1NQ		0.83		
PCI-5.0UFA1NQ		1.03		
PCI-6.0UFA1NQ		1.03		
PCI-6.5UFA1NQ		1.18		

Current(A)	Wire Size (mm <sup>2</sup> )	Current(A)	Wire Size (mm <sup>2</sup> )
i<6	2.5	25<i≤32	6
6<i≤10	2.5	32<i≤40	10
10<i≤16	2.5	40<i≤63	16
16≤i≤25	4	63<i	*1

\*1 In the case that current exceeds 63A, do not connect cables in series.

5. Check to ensure that the ground wire is connected.

## 6.2 Electrical Wiring Connection for Indoor Unit

1. The electrical wiring connection for the indoor unit is shown below.

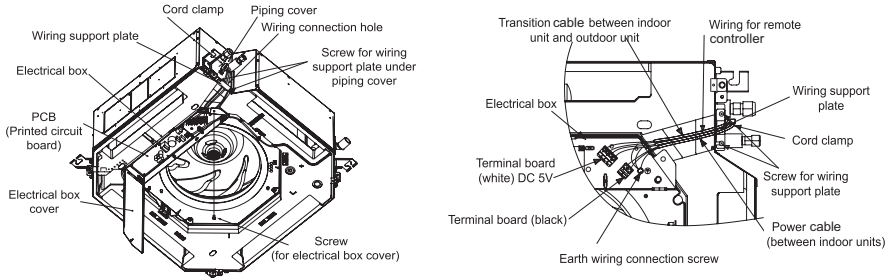

2. Remove the electrical box cover (1 screw).
3. Loosen two (2) screws for the wiring support plate.
4. Connect the cable of an optional remote control switch or an optional extension cable to the terminals inside the electrical box through the connecting hole in the cabinet.
5. Connect the power cord and earth wirings to the terminals in the electrical box.
6. Connect the wirings between the indoor unit and the outdoor unit to the terminals in the electrical box.

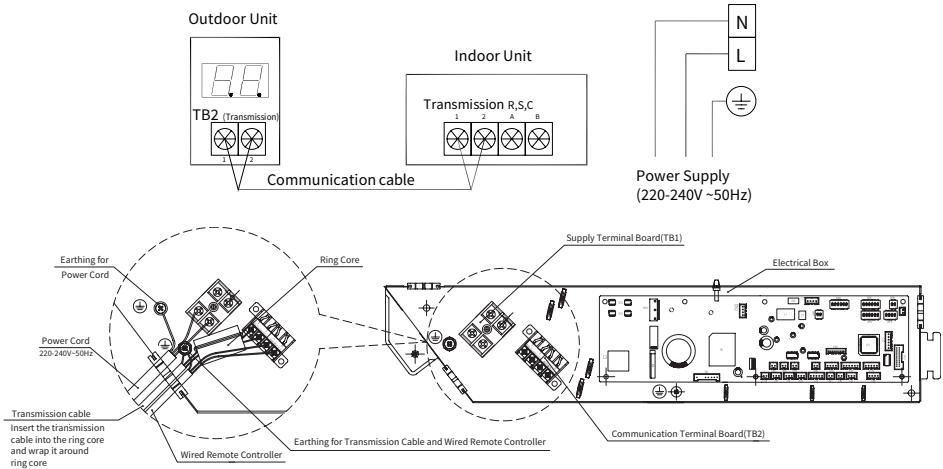

- The ring core needs to be installed on the transmission cable between the fixed wire clamp and TB2, where additional insulation rubber is peeled off.

### [Procedure]

Insert the transmission cable into the ring core as shown in the below figure before connecting to the terminal board. Wrap the transmission cable around the ring core. Fix the cable and the ring core by using the band (accessory) in the electrical box.

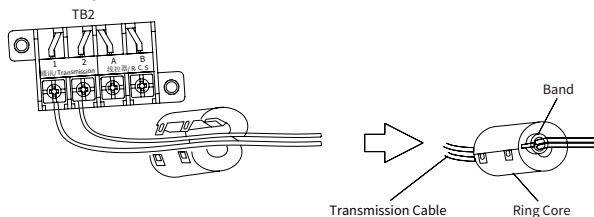

### 6.3 Settings of Dip Switches

#### Quantity and position of dip switches

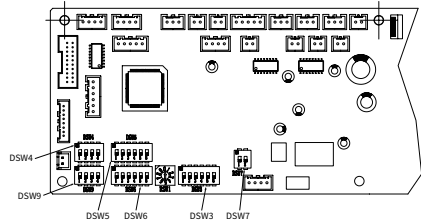

**CAUTION**

- Before setting dips switches, firstly turn off power source and set the position of the dips switches. If the switches are set without turning off the power source, the contents of the setting are invalid.

**NOTES:**

- The mark " ■ " indicates position of dips switches. Figures show setting before shipment or after selection.
- Indication position of rotatory switches.

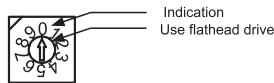

**DSW3: capacity code setting**

This dip switch is utilized for setting the capacity code which corresponds to the Horse Power of the indoor unit.

Factory setting:

DSW3

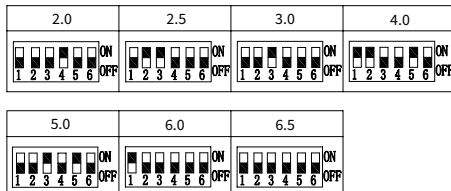

**DSW4: unit model code setting**

This switch is utilized for setting the model code which corresponds to the indoor unit type.

Factory setting:

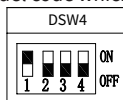



**DSW5: refrigerant cycle No. setting**

Setting is required

Factory setting:

DSW5 can be set from 0 to 63.

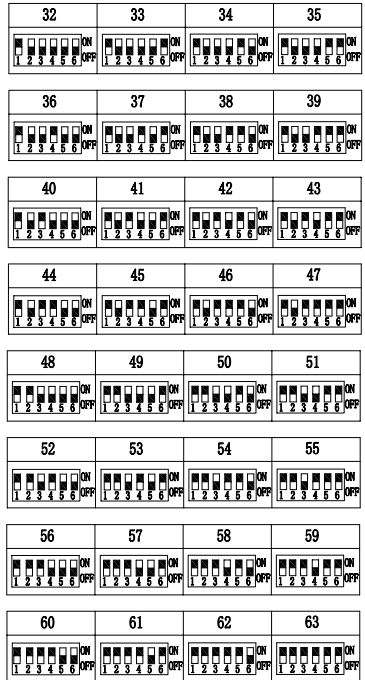
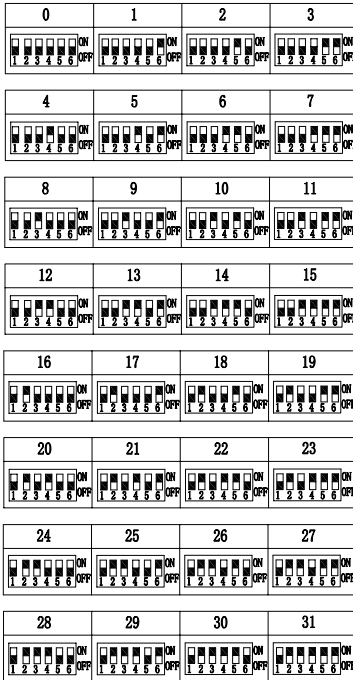
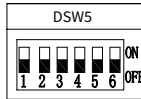

**DSW6: unit No. setting, low air volume setting**

Setting is required.

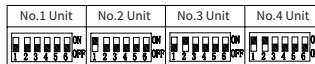
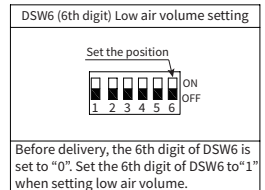
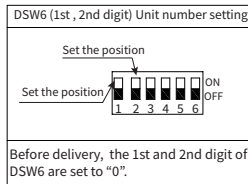

**DSW6(4th digit), RWS1: regional identification**

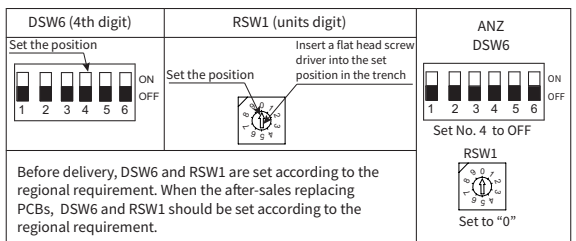

## 7. Remote Controller Operation

### DSW9: Iconic panel setting

Iconic panel is an accessory part.  
Refer to the right picture for the setting.

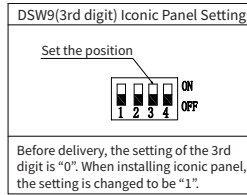

## 7. Remote Controller Operation

Please refer to the Installation and Operation manual of wired remote controller(PC-ARFG2-Z) or wireless remote controller (PC-LH8QE).

## 8. Installation of Optional Air Panel PHKF160PAQ1

### 8.1 Factory-supplied Accessories

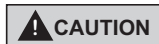

When the air panel is unpacked, place it on insulation material, etc. to protect the sealing insulation from scratches.

Check to ensure that the accessories are packed with the air panel.

Accessory	PHKF160PAQ1	Purpose
Long Screw (M6 Cross Screw)	4	For fixing air panel

If any of these accessories are not packed in the packing, please contact your contractor.

### 8.2 Installation

#### Check the indoor unit height from the false ceiling surface

Check the distance between the indoor unit and the false ceiling.  
It is 12±5mm as shown below.

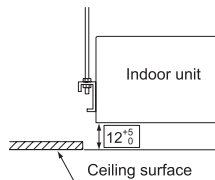

If not, adjust the distance by using the checking scale with maintaining the levelness of the indoor unit.

### Removing air intake grille from air panel

1. Push both ends of knobs at the air inlet grille toward the arrow direction, open the air inlet grille until the angle of approximately 45° from the air panel surface. After lifting the air inlet grille keeping it inclined, draw the air inlet grille forward. (Remove the filament tape (4 portions) fixing the air filter.).

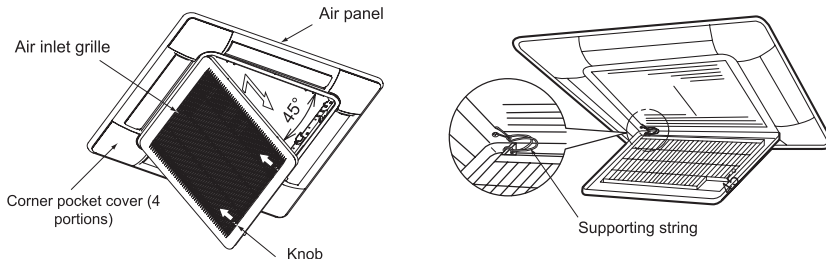

2. Lift the grille keeping it inclined.
3. Draw the grille towards the open space after lifting.

#### NOTE:

- Perform the attaching work in the reverse procedure of removing for install the air intake grille. The air inlet grille can be attached from any 4 directions by rotating it. The air grille direction can be selected freely.

### Installing air panel

1. Remove the cover of the corner pocket (4 portions). Remove pulling A part toward the arrow direction.

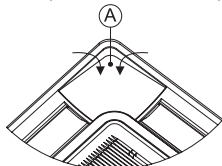

2. Pull down the U-shaped hook (at 2 positions) located at the indoor unit side.
3. Mount the air panel temporarily. Fit the corner position of the refrigerant pipe connection at the indoor unit and the position stamped as "Ref. Pipe" Then, catch the C-shaped hinges (2 portions) onto the U-shaped hooks (2 portions).
4. Fix the air panel to the fixing plate by factory-supplied long screws (M6 cross screws).

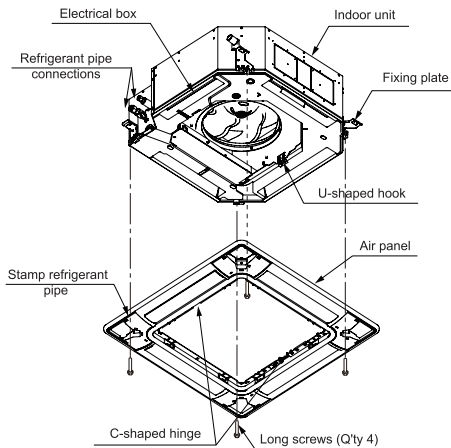

## 8. Installation of Optional Air Panel PHKF160PAQ1

5. Tighten the long screws until touching the stopper to the fixing plate. Check to ensure that the distance between the fixing plate undersurface and the corner panel undersurface is 26mm.
6. When tightening the long screws to prevent air leakage and to be no gap between the false ceiling surface and the indoor unit, the inner circumference of the air panel (the position to attach the air inlet grille) may be slightly deformed. However, it is not abnormality.

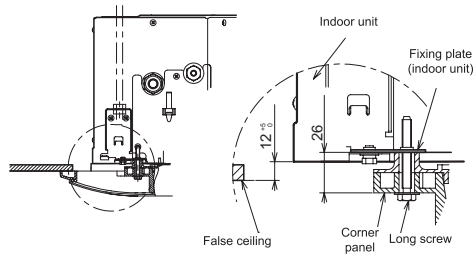

### CAUTION

- If tighten long screws insufficient, may cause something wrong as below.

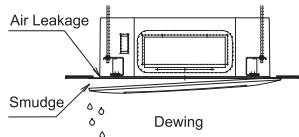

- If any gap has even though tighten long screws sufficient, readjust the height of indoor unit.

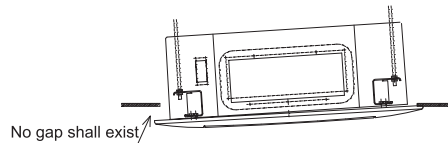

- It's able to adjust the indoor unit height by using wrench from the corner pocket.

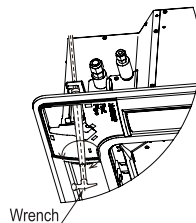

- Too considerable adjustment of height cause dewing from drain-pan.
- Do not turn the air louver by hand. If moved, the louver mechanism would be damaged.

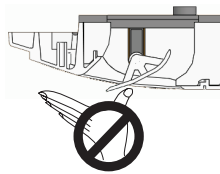

### 8.3 Wiring Connection for Air Panel

1. The following connectors are used in the air panel. Remove the tape fixing the wiring connectors on the air panel and pull out them as shown in the figure below. Connect them with the wiring connectors on the indoor unit.

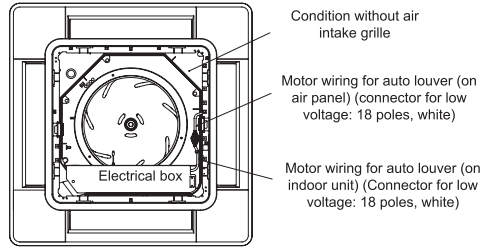

2. After connecting the wire connection of the air panel, attach the air inlet grille. Perform the attaching work in the reverse procedure of removing.

## 9. Maintenance

When the indication, "🌫️" is shown on the display of the remote control switch, take out the air filter according to the indicated steps for each unit.

Do not operate the system without the air filter to protect the indoor unit heat exchanger against being clogged.

Turn OFF the main power switch before taking out the filter. (The previous operation mode may appear.)

### 9.1 Take Out the Filter

1. Open the air inlet grille after pushing the two knobs toward the arrow mark.

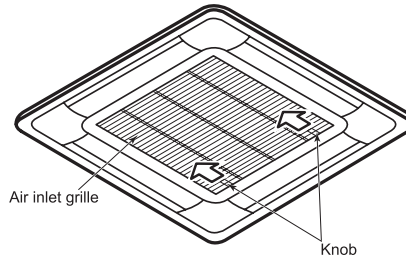

2. Hold the lower side of the air inlet grille keeping it inclined. Remove the hooks of air filter from the air inlet grille and remove the air filter.

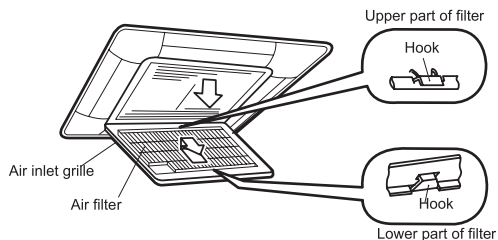

### 9.2 Clean the Filter

Clean the air filter according to the following steps.

1. Use a vacuum cleaner or let water flow onto the air filter to removing the dirt from the air filter.



- Do not use hot water higher than approximately 40°C.
2. Dry the air filter in the shade after shaking of moisture.
  3. Do not use cleaner or other chemicals.
  4. After the air filter is dried, attach and close correctly to the air inlet grille.

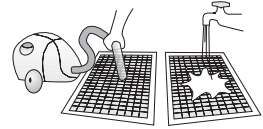

### 9.3 Reset of Filter Indication

After cleaning the air filter, reset the filter sign according to the remote control procedure.

### 9.4 Safety and Control Device Setting

Model		PCI-(2.0-6.5)UFA1NQ	
For Control Circuit Fuse Capacity	A		5
Freeze Protection Thermostat	Cut-Out	°C	0
	Cut-In	°C	14
Thermostat Differential		°C	2

# MEMO

# Packing List

Item	Q'ty
Indoor Unit	1
Operation Installation and Maintenance Manual	1
Washer with insulation material (M10)	4
Washer (M10)	4
Drain hose	1
Hose clamp	1
Ring core	1
Wire clamp (only in PCI 2.0/2.5/3.0UFA1NQ)	1
Pipe insulation(small)	1
Pipe insulation(big)	1
Cord clamp(small)	2
Cord clamp(big)	7
Insulation(5Tx 50 x200)	1
Insulation (5Tx 270 x270)	1
Screw(M4x10) (only in PCI 2.0/2.5/3.0UFA1NQ)	2
Wire Harness	1



1184258

## Hitachi-Johnson Controls Air Conditioning, Inc.

Add: 1-16-1, Kaigan Minato-ku, Tokyo, Japan

---

Specifications in this catalogue are subject to change without notice, in order that Hitachi-Johnson Controls may bring the latest innovations to customers.