

INSTALLATION & MAINTENANCE MANUAL

Premium Zoning Kit for

airCore 700



MODELS

GC-AZKP

GC-ZKT

PC-ARFG2-Z



Cooling & Heating

Preface

- The Zone Interface Box is required to be connected to at least one wired remote controller (model PC-ARFG2-Z) and at least one temperature sensor (using sensor of indoor unit, wired remote controller, or optional part like remote sensor (model THM-R2A) or thermostat(model GC-ZKT)). Refer to sample configuration in figure 2.1.
- Do not install this Zone Interface Box in the following places. If installed, it may cause a fire, malfunction and corrosion.
 - Places that are subject to oily fumes.
 - Places where inflammable gas may be generated or flowed.
 - When the paired air conditioner is an R32 refrigerant type, the installation height of the Zone Interface Box cannot be lower than that of the air conditioner installed in the same space.
 - Places where strong salty wind blows such as coastal regions.
 - Highly corrosive environments such as places where sulphide gas forms near hot spring.
- Do not install this Zone Interface Box in the following places. If installed, it will cause corrosion.
 - Environments that have high acidity or alkalinity content.
- Do not install this Zone Interface Box in the following places. If installed, it may cause malfunction and failure.
 - Places where the Zone Interface Box is exposed to the direct sunlight.
 - Places where the temperature exceeds 60°C.
 - Places where the Zone Interface Box may be wet.
- Do not install this Zone Interface Box where the electromagnetic wave is directly radiated to the electrical parts.
- Do not install this Zone Interface Box within 3 meters from strong electromagnetic wave radiators such as medical equipment.

Important Notice

- Johnson Controls-Hitachi Air Conditioning pursues a policy of continuing improvement in design and performance in its products. As such, Johnson Controls-Hitachi Air Conditioning reserves the right to make changes at any time without prior notice.
- Johnson Controls-Hitachi Air Conditioning cannot anticipate every possible circumstance that might involve a potential hazard.
- This Zone Interface Box is designed for human comfort air conditioning applications only. Do not use this Zone Interface Box for anything other than the purposes for which it was intended for.
- The installer and system specialist must safeguard against leakage in accordance with local plumbing and electrical codes. The following standards may be applicable, if local regulations are not available. International Organization for Standardization: (ISO 5149 or European Standard, EN 378).
- No part of this manual may be reproduced in any way without the expressed written consent of Johnson Controls-Hitachi Air Conditioning.
- It is assumed that the Zoning Kit (including Zone Interface Box, Wired Remote Controller and Thermostat) will be operated and serviced by people conversant in English. If this is not the case, the customer should add safety such as caution and operating signs in a familiar language for non English speakers.
- If you have questions, please contact your distributor or dealer.
- This manual provides common descriptions, basic and advanced information to maintain and service this Zone Interface Box which you operate as well for other models.
- This manual should be considered as a permanent part of the Zone Interface Box and should be kept by user for future reference.

Product Inspection upon Arrival

1. Upon receiving this product, inspect it for any damages incurred in transit. Claims for damage, either apparent or concealed, should be filed immediately with the shipping company.
2. Check the model number, electrical characteristics (power supply, voltage, and frequency rating), and any accessories to determine if they meet the requirements of the installation.
3. The standard utilization for this unit is explained in these instructions. Use of this equipment for purposes other than what it designed for is not recommended.
4. Please contact your installer or local service agent to discuss any issues involving installation, performance or maintenance.
5. Liability does not cover defects originating from unauthorized modifications performed by a customer without the written consent of Johnson Controls-Hitachi Air Conditioning. Performing any mechanical alterations on this product without the consent of the manufacturer renders your warranty null and void.

NOTICE

- Please keep this manual in a safe place for future installation and operation reference.
- This zone control kit is designed to be used only with the list of equipment shown in table 2.4 Compatible Air Conditioning Units and when connected, forms part of the air conditioning system.
- This installation manual applies to Zoning Kit. Please also refer to the installation manual of Wired Remote Controller (PC-ARFG2-Z) and connected air conditioners for detailed installation instructions for these.
- Read and understand this manual before installing the Zone Interface Box.

Table of Contents

1. Safety Summary	1
2. Zoning Kit Configuration.....	4
2.1 Product and Accessories	4
2.2 Optional Parts (Sold and Supplied Separately)	5
2.3 Zoning Kit Application	5
2.4 Compatible Air Conditioning Unit.....	6
3. Specifications	7
3.1 Zone Interface Box Specifications.....	7
3.2 Thermostat Specifications	8
3.3 Other Specifications	9
4. Procedure Overview	9
5. Installation Work	10
5.1 Zone Interface Box Installation	10
5.2 Wired Remote Controller Installation.....	11
5.3 Thermostat Installation.....	13
6. Electrical Wiring.....	15
6.1 Wiring Procedures.....	15
6.2 Wiring Work.....	15
6.3 Wiring Diagrams.....	21
7. Field Setting	22
7.1 Zone Installation Setting.....	22
7.2 Indoor Unit Configuration Setting	33
7.3 Premium Zoning Kit Notes	34
8. Test Run	35
9. Indoor Unit Control	35
10. Zone Control	36
10.1 Zone Control by Wired Remote Controller	36
10.2 Zone Control by Thermostat	40
11. Alarm Codes.....	45
12. Maintenance and Service	46

1. Safety Summary

- Please carefully read this section before installing the Zoning Kit.
- Contents with “**⚠ WARNING**” shows the certain cases where improper operation WILL result in severe personal injury or even death. For your safety, please follow the instruction.
- Ensure that the entire system is correctly wired and installed before turning on power. Once the appropriate checks have been made, turn the power on to the zoning kit and the air conditioning system.

Signal Words

⚠ WARNING	Indicates a hazardous situation that, if not avoided, could result in death or serious injury.
⚠ CAUTION	Indicates a hazardous situation that, if not avoided, could result in minor or moderate injury.
NOTICE	Indicates information considered important, but not hazard-related (for example, messages relating to property damage).

General Precautions

⚠ WARNING	To reduce the risk of serious injury or death, read these instructions thoroughly and follow all warnings or cautions included in all manuals that accompanied the product and are attached to the unit. Refer back to these safety instructions as needed.
------------------	---

- This air conditioning system, including this Zoning Kit, should be installed by personnel qualified according to local, state and national building and safety codes and regulations. Incorrect installation could cause leaks, electric shock, fire or an explosion. In areas where Seismic Performance requirements are specified, the appropriate measures should be taken during installation to guard against possible damage or injury that might occur in an earthquake. If the unit is not installed appropriately, injuries may occur because of a falling unit.
- Use appropriate Personal Protective Equipment (PPE), such as gloves, protective goggles and electrical protection equipment and tools suited for electrical installation purposes.
- When transporting, be careful when picking up, moving and mounting these units. Although the controller (including Wired Remote Controller and Thermostat) may be packed using plastic straps, do not use them for transporting from one location to another. Do not stand on or put any material on the controller.
- When connecting the controller cabling to the units, do not touch or adjust any safety devices inside the products. All safety features, disengagement, and interlocks must be in place and functioning correctly before the equipment is put into operation. If these devices are improperly adjusted or tampered with in any way, a serious accident can occur. Never bypass or short-out any safety device or switch.
- Use only Johnson Controls-Hitachi Air Conditioning genuine replacement parts.
- Johnson Controls-Hitachi Air Conditioning will not assume any liability for injuries or damage caused by not following steps outlined or described in this manual. Unauthorized modifications to Johnson Controls-Hitachi Air Conditioning products are prohibited as they:
 - May create hazards which could result in death, serious injury or equipment damage;
 - Will void product warranties;
 - May invalidate product regulatory certifications.

NOTICE

Take the following precautions to reduce the risk of property damage.

- Do not touch the main circuit board or electronic components in the controller or remote devices. Make sure that dust and/or steam does not accumulate on the circuit board.
- Avoid installing the unit in areas where electromagnetic waves are generated, as Electromagnetic interference (EMI) may cause the equipment to malfunction. Do not install where the waves can directly radiate into the electrical box, controller cable, or controller. The operation of the unit may also adversely affect these same devices. Install the unit at least 3m away from such devices.
- If the controller is installed in a location where electromagnetic energy is generated, make sure that the Wired Remote Controller is shielded and cables are run inside conduit tubing.
- If there is a source of electrical interference near the power source, install noise suppression equipment (filter).
- This manual must be read in conjunction with the installation and operation manuals of other equipment being installed to get a full understanding of the equipment and installation related topics.

Installation Precautions**⚠ WARNING**

Take the following precautions to reduce the risk of electric shock, fire, or explosion resulting in serious injury or death:

- Prior to commencing the installation process, please carefully read and follow this manual. Improper installation can cause electric shock, fire or unexpected accidents.
- Ensure that the installation location is strong enough and the Zone Interface Box is adequately secured. If not, the Zone Interface Box may fall down and could result in injury.
- Perform a test run using the Wired Remote Controller to ensure normal operation. Safety guards, shields, barriers, covers, and protective devices must be in place while the compressor/unit is operating. During the test run, keep fingers and clothing away from any moving parts.

After installation work for the air conditioning system (including Zoning Kit) has been completed, explain the "Safety Summary", use and maintenance of the unit to the customer according to the information in all manuals that accompanied the system. All manuals and warranty information must be given to the end user for safekeeping and future reference.

Electrical Precautions

WARNING

Take the following precautions to reduce the risk of electric shock, fire, or explosion resulting in serious injury or death:

- All electrical work must be undertaken by a suitably qualified electrician.
- Follow the local codes and regulations, and this manual when performing electrical wiring. Please also ensure to utilize specified circuit. Circuit capacity shortage and improper wiring may cause electric shock and/or fire.
- Utilize specified cable for wiring power, air conditioners, damper motors, remote sensors, Wired Remote Controller, Thermostat and/or other external devices. Other cables may cause electric shock and/or fire.
- Before removing the cover of the Zone Interface Box, turn off the power supply to avoid accidental electrical shocks.
- Only use electrical protection equipment and tools suited for this installation.
- Insulate the Wired Remote Controller and Thermostat against moisture and temperature extremes.
- Use specified cables between controller and other products.
- Communication cabling must be a minimum of 18-Gauge, 2-Conductor, Stranded Copper. Shielded cable must be considered for applications and routing in areas of high EMI and other sources of potentially excessive electrical noise to reduce the potential for communication errors. When shielded cabling is applied, proper bonding and termination of the cable shield is required as per Johnson Controls-Hitachi Air Conditioning guidelines. Plenum and riser ratings for communication cables must be considered per application and local code requirements.
- The polarity of the input terminals is important, so be sure to match the polarity when using contacts that have polarity.
- Highly dangerous electrical voltages may be used in this Zoning Kit. Carefully refer to the wiring diagram and these instructions when wiring. Improper connections and inadequate grounding can cause serious injury or death.
- Before installing the Zoning Kit or remote devices, ensure that the indoor and outdoor unit operation has been stopped. Further, be sure to wait at least five minutes before turning off the main power switch to the indoor or outdoor units. Otherwise, water leakage or electrical breakdown may result.
- Do not open the service cover or access panel to the indoor or outdoor units without turning OFF the main power supply. Before connecting or servicing the Zoning Kit or cables to indoor or outdoor units, open and tag all disconnect switches. Never assume electrical power is disconnected. Verify with a meter and equipment.
- Use an exclusive power supply at the controller's rated voltage.
- Be sure to install circuit breakers (earth leakage breakers, isolating switch, molded case circuit breaker, and so forth) with the specified capacity. Ensure that the wiring terminals are tightened securely to recommended torque specifications.
- Clamp electrical wires securely with cable ties after all wiring is connected to the terminal block. In addition, run wires securely through the wiring access channel.
- When installing the power lines, do not apply tension to the cables. Secure the suspended cables at regular intervals, but not too tightly.
- Make sure that the terminals do not come into contact with the surface of the electrical box. If the terminals are too close to the surface, it may lead to failures at the terminal connection.
- Do not pour water on the controller as it could cause electric shock and/or damage the unit. Do not use strong detergent such as a solvent. Clean with a soft cloth.
- Check that the ground wire is securely connected. Do not connect ground wiring to gas piping, water piping, lighting conductor, or telephone ground wiring. Only use electrical protection equipment and tools suited for this installation.



2. Zoning Kit Configuration

The terminologies used in this specification are as following:

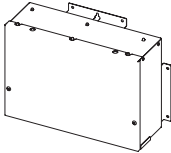

Terminology	Definitions
Enable/Disable Zone	Zone Interface Box supports the control of 8 zones, but during installation, any zone of the 8 zones that is not used can be disabled through primary Wired Remote Controller. The ON/OFF, airflow control, temperature control of a disabled zone cannot be accessed by users and Zone Interface Box does not process the info from a disabled zone.
Spill Zone	A zone that has a zone motor and damper installed that is set to automatically open when either too few zones are open or all zones are turned off. This prevents the ducting working under excessive pressure condition and being blown out if too many zones are closed. It also assists in keeping the air flow ratio of the indoor unit above the minimum allowable volume. The spill zone is usually the zone with the largest room area and the most amount of supply air grills.
Common Zone	A zone without a zone motor or damper that will always deliver air to the conditioned space whenever the system is running.
Minimum Airflow Ratio	The air conditioning system requires the amount of air being delivered to the conditioned space to be within a minimum and maximum range. As zones are turned off, the volume of air being delivered reduces and must be kept above the minimum airflow ratio.
Base Set Temperature	The base set temperature of zoning system, set temperature of all individual enabled zones is limited to $\pm 3^{\circ}\text{C}$ from this base set temperature.

2.1 Product and Accessories

The product is provided with following parts as in table below .

Name	Shape	Qty.
Zone Interface Box (GC-AZKP)		1
Installation & Maintenance Manual		1

2.2 Optional Parts (Sold and Supplied Separately)

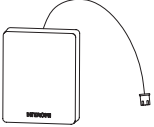
Name	Model	Shape	Summary
Wired Remote Controller	PC-ARFG2-Z		For air conditioner and Zone Interface Box operation, at least 1 controller is needed.
Thermostat	GC-ZKT		For individual zone operation and room temperature detection.
Remote Sensor	THM-R2A		For room temperature detection, THM-R2A is with a cable of eight meters.

2.3 Zoning Kit Application

This installation & maintenance manual is exclusively for the Zone Interface Box (GC-AZKP). Sample of Zoning Kit application is illustrated in figure 2.1. Please also refer to corresponding installation & maintenance manuals of connected air conditioners, Wired Remote Controller (PC-ARFG2-Z) and other devices connected to the system.

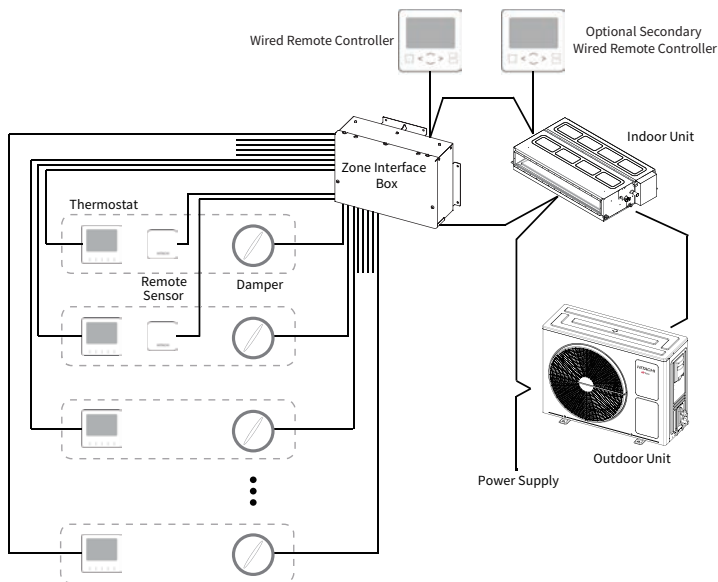

Figure 2.1 Sample of System Configuration

NOTES:

1. Zone control functions are available only with a Wired Remote Controller PC-ARFG2-Z connected. Zone control functions are not available with other types of controllers.
2. Any other types of central controller can not be connected.
3. The zoning kit can comprise of only
 - one zone interface box connected to a single split system with indoor units listed in table 2.4 Compatible Air Conditioning Units.
 - up to two wire remote controllers (PC-ARFG2-Z), one installed to ZIB and one to indoor unit E-BOX.
 - up to eight zone motors and thermostats.
 - up to two remote temperature sensors.
4. The Wired Remote Controller connected in Zoning Kit can only connect to one Indoor Unit.
5. Remote Sensors must not be connected to Indoor Unit PCB. To enable correct operation and sensing, the remote temperature sensors must be connected to the Zone Interface Box.
6. Careful attention must be given to ensure that the air flow rate through the indoor fan coil unit is within the allowable range as specified in the technical data manuals.
7. The zone damper motors must be connected to respective terminals in the Zone Interface Box.
8. Under certain conditions in the cooling cycle - particularly when the air flow rate is low, the temperature of the supply air may reduce to a level that may cause condensation on the indoor unit and/or the duct and fittings. Due care must be taken to ensure that the condensate does not drip onto the ceiling or into the conditioned space. Additionally, it is recommended that a safety drain tray be installed under the indoor unit and drained away separately.

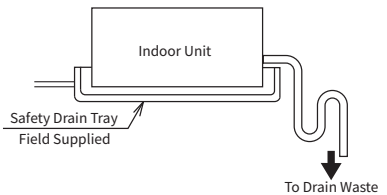

Figure 2.2 Safety Drain Tray

9. When using a zoning kit, the optional accessories below cannot be connected:
 - Panel with louver
 - Electricity heater or reheat coil
 - Human sensor
 - IR receiver for wireless controller

2.4 Compatible Air Conditioning Unit

Indoor Unit Type	Model	Minimum Airflow Ratio
Medium ESP ducted	PPIIM-2.0UFA1NQ	46%
	PPIIM-2.5UFA1NQ	46%
	PPIIM-3.0UFA1NQ	58%
	PPIIM-4.0UFA1NQ	56%
	PPIIM-5.0UFA1NQ	53%
	PPIIM-6.0UFA1NQ	56%
High ESP ducted	PPIIH-3.0UFA1NQ	58%
	PPIIH-4.0UFA1NQ	57%
	PPIIH-5.0UFA1NQ	61%
	PPIIH-6.0UFA1NQ	59%
	PPIIH-6.5UFA1NQ	56%

3. Specifications

3.1 Zone Interface Box Specifications

Item	Specification
Model	GC-AZKP
Dimension (mm)	W324 x H226 x D110
Net Weight	3.95Kg
Installation Place	For indoor installation
Ambient Temperature	-20 °C ~60 °C
Ambient Humidity	10%~95% RH (applied under no condensation condition)
Rated Power Supply	AC 230V±10%/50Hz/1Ph
Power Consumption	Standard input 10w
Pollution Degree	II
Impulse Test Voltage	2500V
Action Type	1.B

Dimensions:

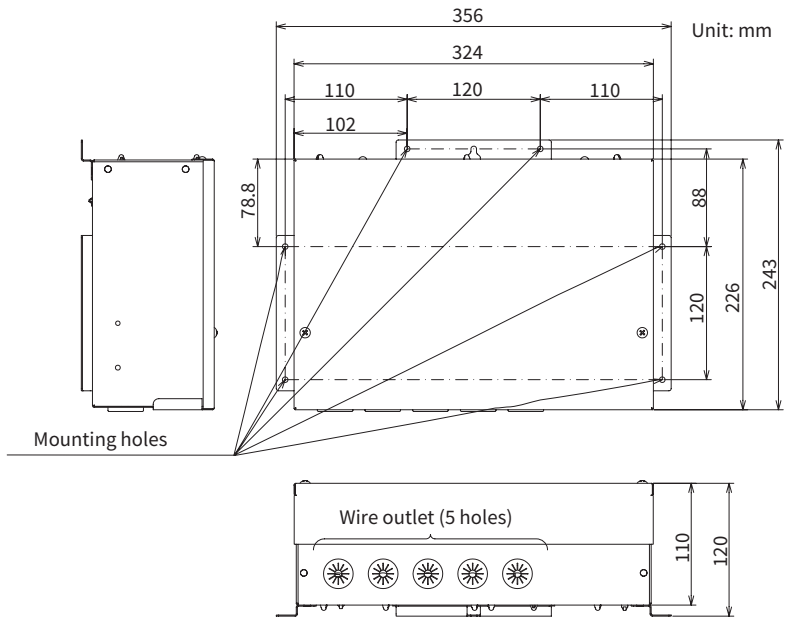

Figure 3.1 Zone Interface Box Dimensions

Component Names

Figure 3.2 below shows the Zone Interface Box with the cover removed. The names of each component is labeled in the figure below with the function of each in brackets (). For detailed wiring instructions, please refer to section "6. Electrical Wiring".

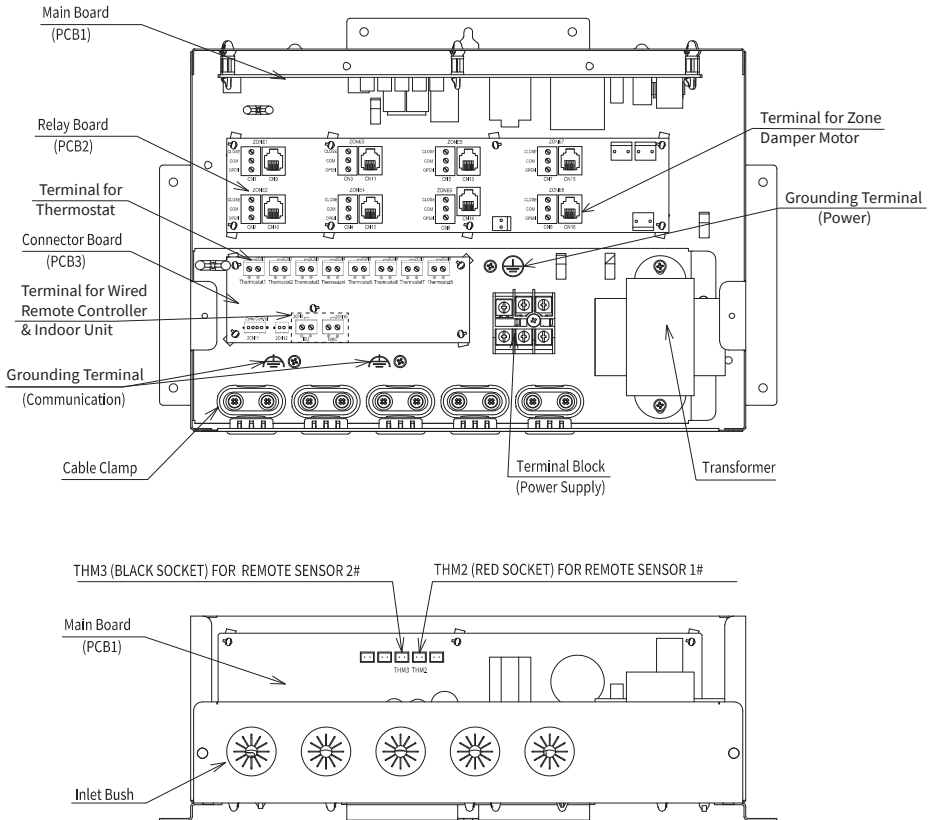

Figure 3.2 Names of Inner Parts

3.2 Thermostat Specifications

Item	Specification
Model	GC-ZKT
Dimension (mm)	W90 x H90 x D15.5mm (thinnest part) W90 x H90 x D18.5mm (thickest part)
Net Weight	100g(approx.)
Installation Place	Installed on the wall or switch box
Ambient Temperature	0°C ~40 °C
Ambient Humidity	35%~90%RH (applied under no condensation condition)
Rated Power Supply	DC 15V±10%
Power Consumption	1W
Pollution Degree	II

3.3 Other Specifications

Zone Damper Motors (field supplied)

Item		Specification
Damper Motor	Damper Motor Type	Drive open or drive close
	Voltage	AC 24 V
	Frequency	50 Hz
	Maximum Operating Current (per damper motor)	167 mA or less
	Maximum Electric Power (per damper motor)	4 VA or less
Damper Motor Connection Type		RJ12 or 3 wires

NOTE:

- Spring return motors cannot be used.

Remote Sensor (optional)

Item	Specification
Model	THM-R2A
Cable Length	8 m
Configuration in System	Up to 2

4. Procedure Overview

This manual describes how to install Zone Interface Box. Follow instructions 1~3 to install Zone Interface Box. Please prepare the following manuals.

A	Wired Remote Controller Installation & Maintenance Manual
B	Wired Remote Controller Operation Manual
C	Indoor Unit Installation and Maintains Manual

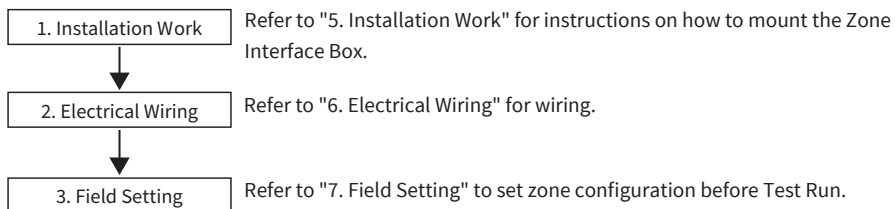

5. Installation Work

5.1 Zone Interface Box Installation

5.1.1 Place to Install

Select a place that meets following requirements:

- (1) Refer to the clause "1. Safety Summary" of this installation manual.
- (2) Place where Zone Interface Box can be securely fixed.
- (3) Place where the Zone Interface Box cannot be tampered with.

5.1.2 Installation Procedure

- (1) Minimum installation space requirements as illustrated in figure 5.1.

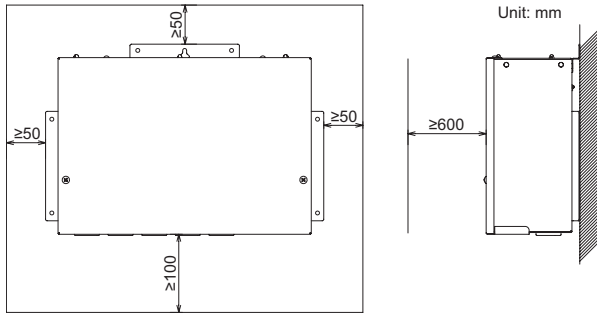

Figure 5.1 Installation Space

- (2) Installation on a flat surface

- a. The Zone Interface Box can be mounted in the horizontal or vertical position. When installed in the vertical position, please make sure that the wire outlets are facing downwards.

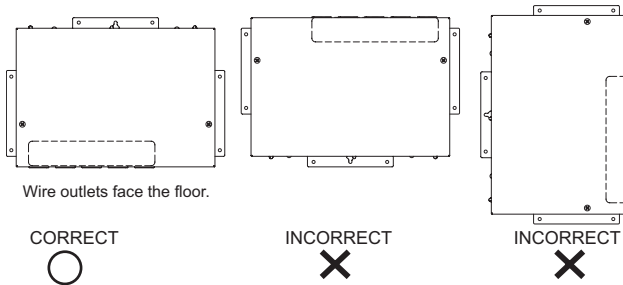

Figure 5.2 Direction for Installing Zone Interface Box





- b. Firmly fix Zone Interface Box on a flat surface through six holes with M5 screws (M5 screws are field-supplied).

5.2 Wired Remote Controller Installation

The Wired Remote Controller model compatible with the Zone Interface Box is PC-ARFG2-Z. For detailed installation, please see steps below.

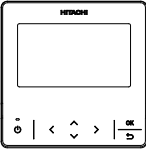
[Before Installation]

(1) This packing contains the following parts.

Name	PC-ARFG2-Z	Operation Manual	Installation & Maintenance Manual	Screw
Appearance				 M4 x 16mm
Qty.	1	1	1	2

(2) When installing two controllers one above the other, allow a gap of at least 50mm between the two.

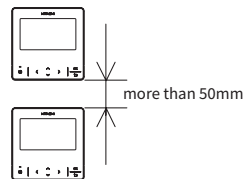

[Installation Procedures]

(1) Insert the edge of the slotted screwdriver into the groove at the bottom of the holding bracket, push and turn the slotted screwdriver to separate and remove the controller from the mounting plate.

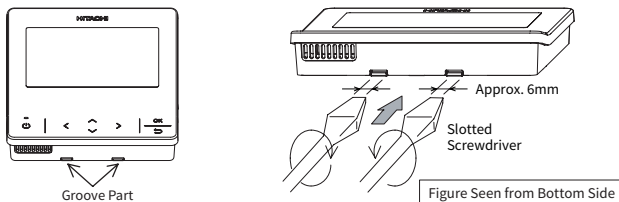

NOTE:

- Do not insert the slotted screwdriver into the tab beside the groove. The tab may be damaged and the advanced color wired remote controller cannot be installed.

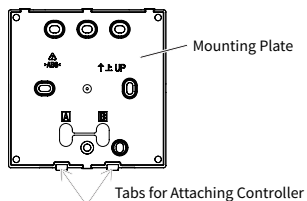

INSTALLATION & MAINTENANCE MANUAL

- (2) According to different controller installation methods, choose one of the following two ways to install the mounting plate and connect the cable .

Method 1 : To mount the controller directly on the surface of a wall:

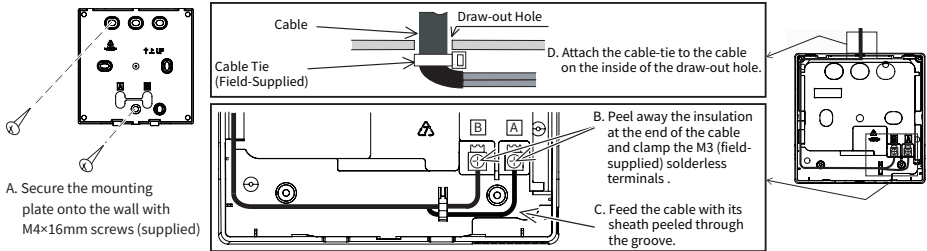

Method 2 : to install the controller on a surface mounting box:

- Prepare the optional field-supplied surface mounting box which can fit the mounting plate.
- Feed the cable through the conduit in the wall.

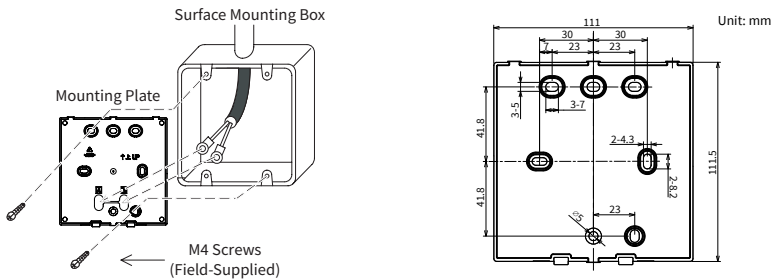

- Cut away the insulation at the end of the cable and clamp the M3 solderless terminals (field-supplied).

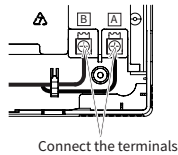

- (3) Re-attach the controller body to the controller mounting plate. Be careful not to pinch the cable when attaching it.

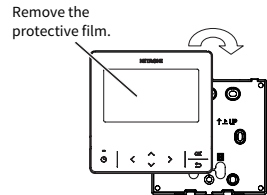

- (4) After installation, remove the protective film from the LCD screen.



5.3 Thermostat Installation

[Before Installation]

(1) This packing contains the following parts.

Item	Thermostat(GC-ZKT)	Screw	Connecting Wire
Appearance		 M4 × 16mm	
Qty.	1	2	1

(2) When installing two thermostats one above the other, allow a gap of at least 50mm between the two.

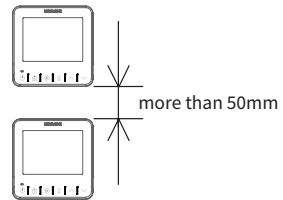

[Installation Procedures]

(1) Insert the edge of the slotted screwdriver into the groove at the bottom of the mounting plate, push and turn the slotted screwdriver to separate and remove the thermostat from the mounting plate.

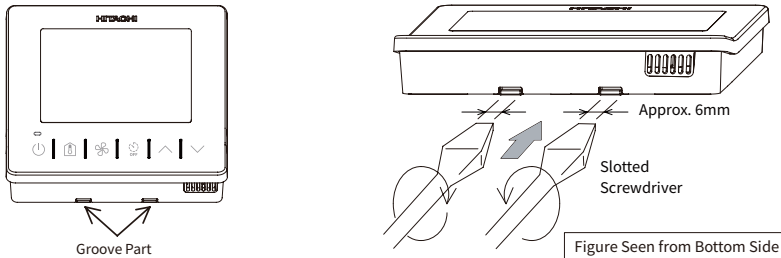

NOTE:

- Do not insert the slotted screwdriver into the tab beside the groove. The tab may be damaged and the thermostat cannot be installed.

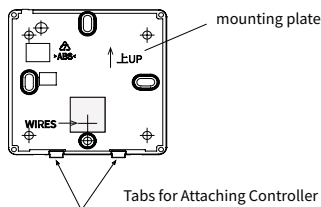

(2) According to different controller installation methods, choose one of the following two methods to install the mounting plate and connect the cable .

Method 1 : To mount the controller directly on the surface of a wall:

- a. Secure the mounting plate onto the wall with M4 × 16mm screws (supplied).
- b. Plug the connector of the connecting wire into CN1 connector.
- c. Connect the supplied cable that has been plugged in to CN1 to the field-supplied cable with suitable connectors or by soldering. Insulate the connections with electrical tape.
- d. Attach a cable-tie to the cable on the inside of the draw-out hole.

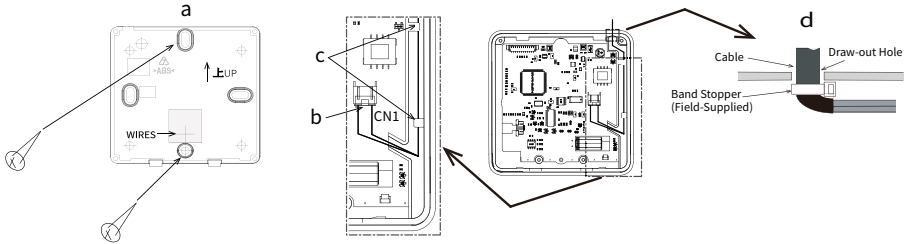

Method 2 : to install the controller on a 86 x 86mm surface mounting box:

- a. Prepare field-supplied 86 x 86mm mounting box.
- b. Feed the cable through the conduit tube in the wall.
- c. Connect the supplied cable that has been plugged in to CN1 to the field-supplied cable with suitable connectors or by soldering. Insulate the connections with electrical tape.
- d. Secure the mounting plate to the mounting box with M4 screws.

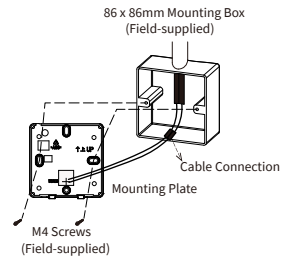

(3) Attach the controller body to the mounted mounting plate.

Be careful not to pinch the cable when attaching it.

(4) After installation, remove the protective film from the LCD screen.

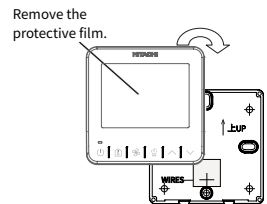

6. Electrical Wiring

6.1 Wiring Procedures

- (1) Read and understand well "1. Safety Summary" in this manual prior to commencing wiring connections.
- (2) The electrical wiring work must be performed by licensed electricians. If not, it may cause an electric shock or a fire.
- (3) Install a high-sensitive high speed ELB (Earth Leakage Breaker) when the rated sensitive current is less than 30mA (The motion time should be within 0.1 second) in the power supply. If it is not used, it will cause an electric shock or a fire.
- (4) Ensure that the power supply is switched off prior to opening the Zone Interface Box cover.
- (5) Take care, and do not pinch electrical wires when assembling the Zone Interface Box cover. It may cause an electrical shock or fire.
- (6) Make sure the field-selected electrical components (breaker, cables and wire terminals) have been properly selected. Make sure that the components comply with NEC (National Electrical Code).
- (7) Check to ensure that all earth wires are properly grounded.
- (8) Check to ensure that the power supply voltage is within $\pm 10\%$ of the rated voltage.
- (9) Check to ensure that each zone damper motor input power is not more than 4VA.
- (10) If the power supply cable is damaged in any way, it must be replaced by a licensed electrician prior to turning the power on.

6.2 Wiring Work

6.2.1 Field Cable Sizes

Model	Power Supply	Maximum Running Current	ELB	Power Cable Specification (L,N, \oplus)	Communication Wire for Wired Remote Controller and Thermostat
GC-AZKP	AC 230V $\pm 10\%$ / 50Hz/1Ph	0.25A	As per indoor installation requirement	0.75mm ²	0.75mm ²

NOTES:

- The Zone Interface Box shall use the same power supply as the indoor unit.
- Please follow the local codes and regulations when selecting field wires. Use the conductor identified by the color combination yellow/green for the ground wire.
- The selected power cables shall not be lighter than the neoprene sheathed cable No. 57 specified by IEC60245-1. The power cables should be copper cables.
- Use a shielded cable for the communication circuit and properly ground the shield layer.
- When using an Insulated Ring Terminal, M4 crimping terminal should be used. When a ring terminal is not used, curve the wire into the shape as shown in the figure below and connect it to tighten the washer uniformly. The screws at the terminal block should be handled according to the tightening torque as shown in the table "Tightening Torque for Terminals".

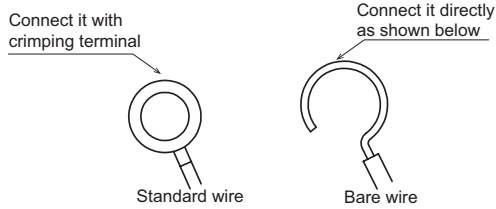

Figure 6.1 Shape of Single Wire for Connection

Tightening Torque for Terminals

Terminals	Size	Tightening Torque (N·m)
Terminal for Wired Remote Controller and Thermostat	M2.5	0.4
Terminal for Power supply	M4	1.0-1.3
Earth connection	M4	1.0-1.3

6.2.2 Wiring Connection

(1) Remove fixing screws and open the Zone Interface Box cover as shown in the figure below.

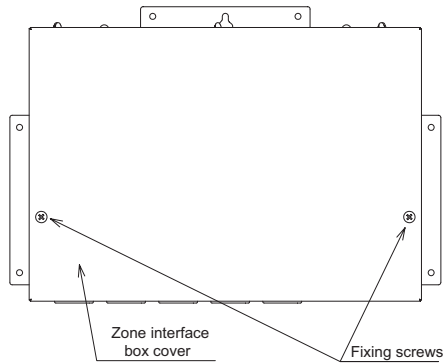

Figure 6.2 The Position of Fixing Screws of Box Cover

(2) Remove the screws of cable clamps cover and insert the wires through the bushes of the wiring inlet openings.

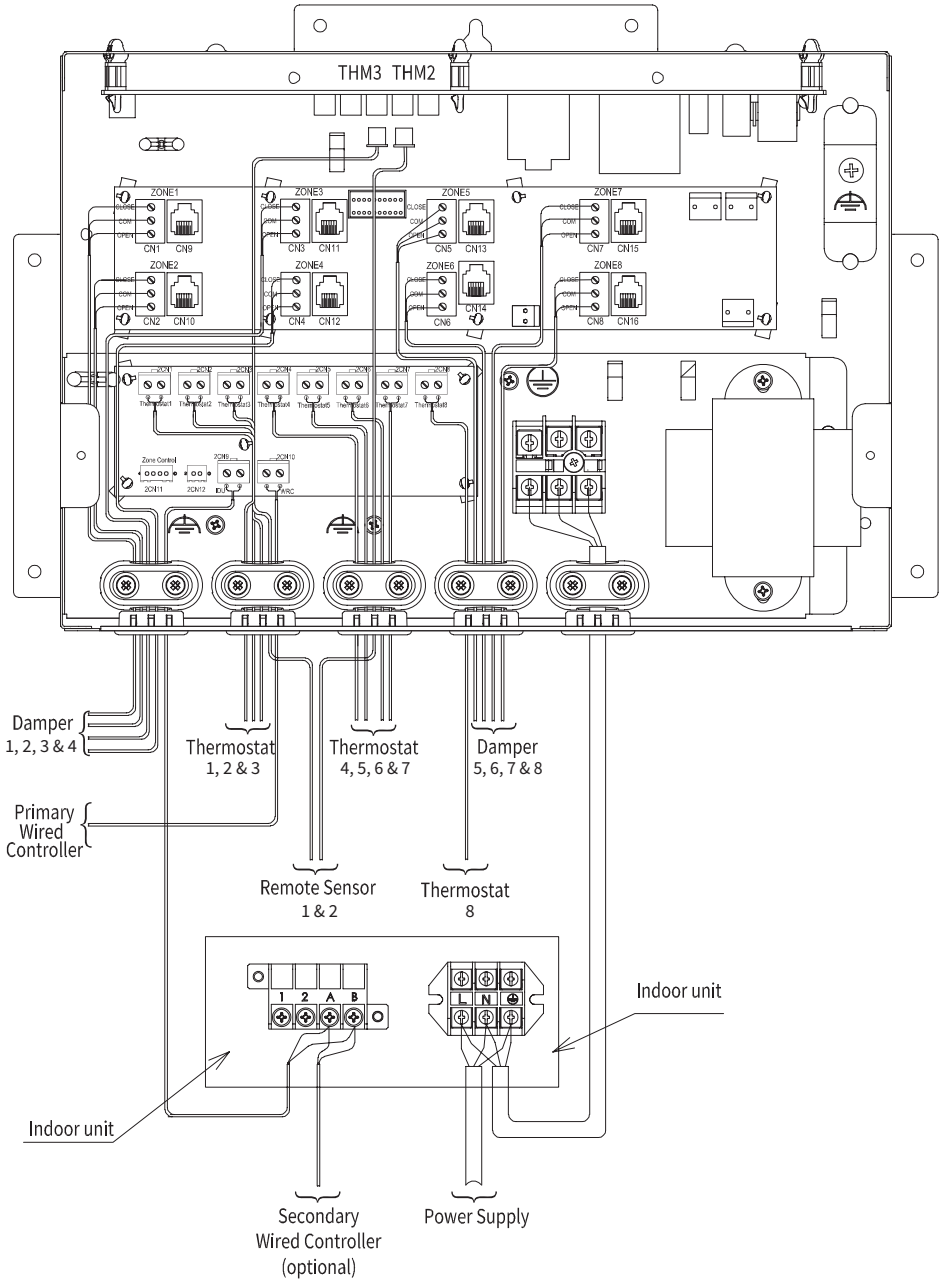

Figure 6.3 Wiring Connection for Screw Terminal Type

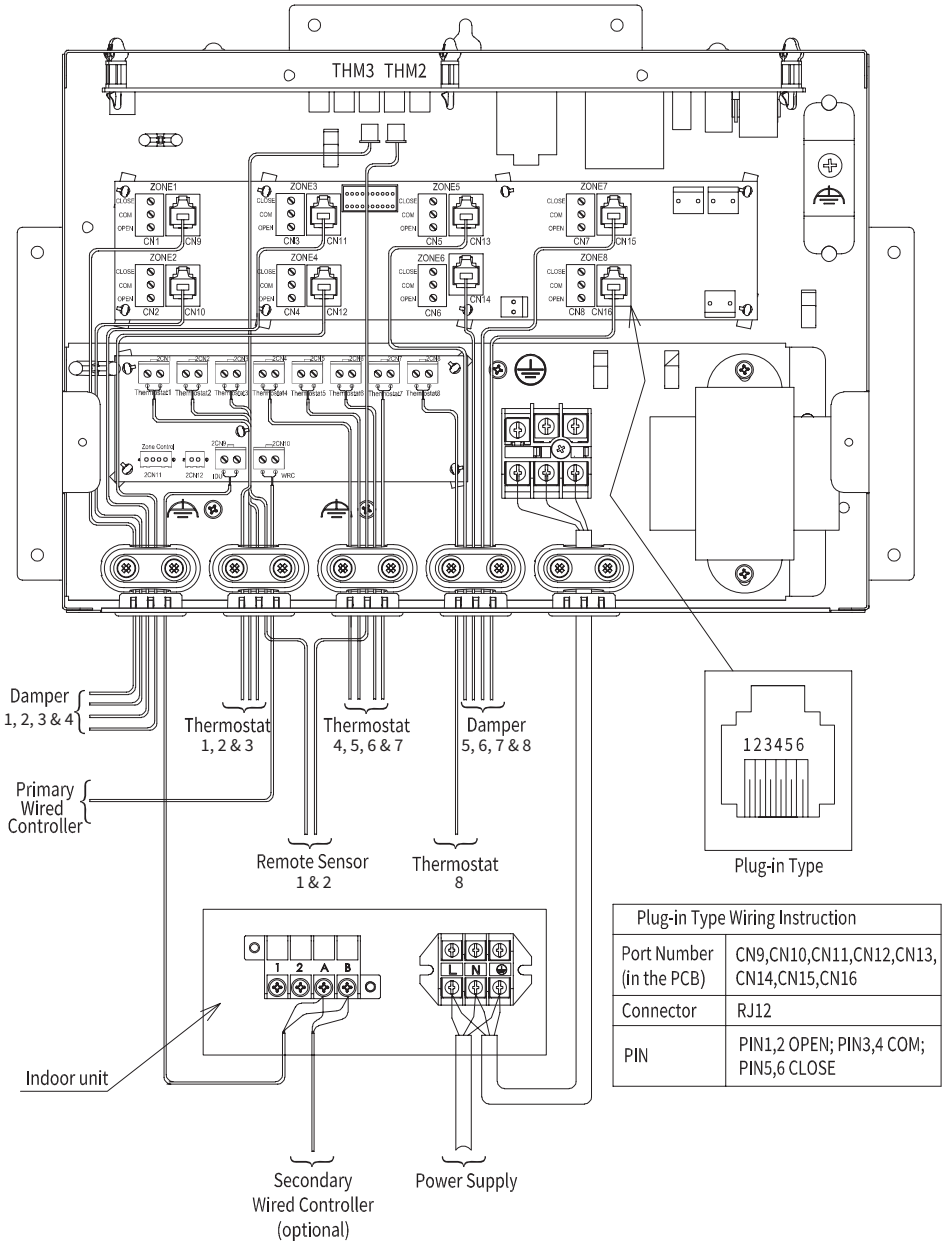

Figure 6.4 Wiring Connection for Plug-in Type

- (3) Carry out the field electrical wiring work as shown in the figure above.
- Connect the power cables to the terminal block (L, N) and earth wire to the grounding terminal in the electrical control box.
 - Connect the Primary Wired Remote Controller to terminal block in the Zone Interface Box, cable length no more than 100m.
 - Connect the communication cables from the terminal block in the Zone Interface Box to the terminal block (A, B) in the indoor unit electrical control box, cable length no more than 50m.
 - The Secondary Wired Remote Controller is optional. If installed, run the interconnecting cables to the terminal block (A,B) in the indoor unit electrical control box.
 - The Remote Sensors (sensor 1 & 2) are optional. If installed, connect these to connectors THM2 and THM3 located on the main board in the Zone Interface Box.
 - Connect zone damper motors to the corresponding connector(ZONE1~ZONE8) on the relay board in Zone Interface Box. For screw terminal type, connect to CN1~CN8 corresponding terminals (OPEN, COM, CLOSE). For plug-in type, dampers need to be connected to CN9~CN16 corresponding terminals (OPEN, COM, CLOSE).
 - Thermostat is connected to 2CN1~2CN8 (Therm. 1~Therm. 8) on the connector board in the Zone Interface Box, with a maximum length of 50m for a single thermostat.

NOTES:

- The zone damper motors must be connected to respective terminals.
 - Do not connect the communication terminal (A,B) of Zone Interface Box to outdoor unit.
 - The Zone Interface Box power cable must be connected to indoor unit power terminal block (see figure 6.3, figure 6.4), and use the same power supply of the indoor unit.
- (4) Re-fix the cable clamp cover and tighten the clamp screw to ensure that the connected harness is securely fastened.
- (5) Check to ensure that all the DIP switched are set to the off ("0") position on the main board as shown in figure below.

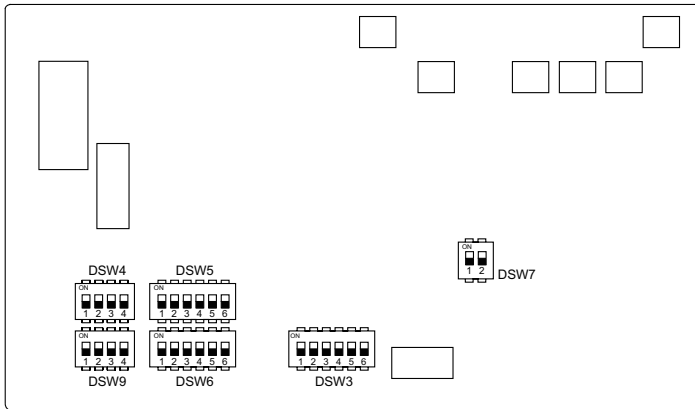

Figure 6.5 DIP Switch

- (6) Install the Zone Interface Box cover after the electrical wiring work is completed.

6.2.3 Wired Remote Controller Wiring Modes

(1) Direct connection (recommended).

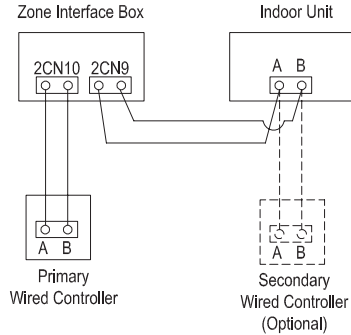

Figure 6.6 Wired Remote Controller Connection Mode1#

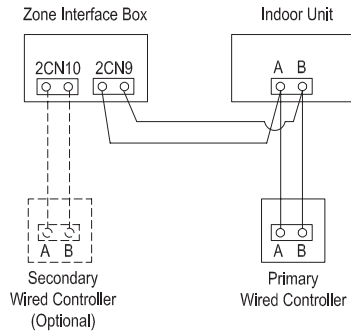

Figure 6.7 Wired Remote Controller Connection Mode2#

(2) Junction box applied.

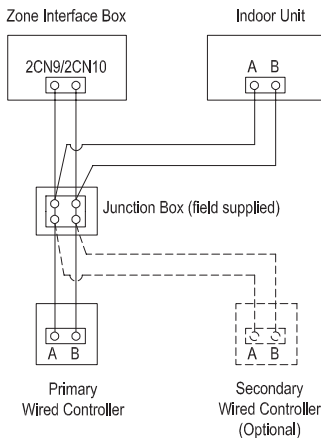
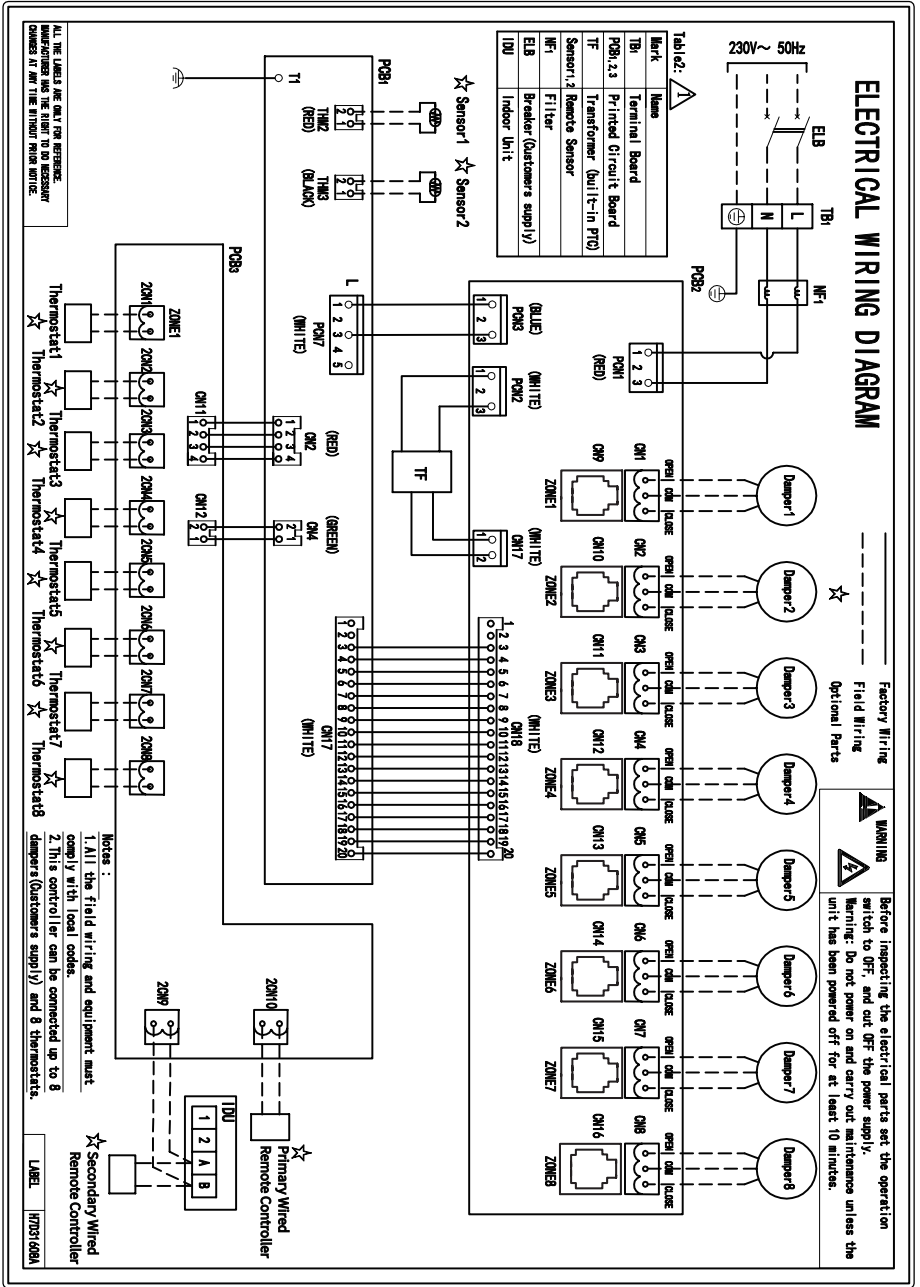

Figure 6.8 Wired Remote Controller Connection Mode3#

6.3 Wiring Diagrams



7. Field Setting

DO NOT Perform Test Run during system starting or before following settings are completed.

7.1 Zone Installation Setting

7.1.1 Zone Configuration Setting

If the wired controller is connected to the zone interface box, the “Zone Installation Menu” is displayed in the “Service & Installation Menu” of Wired Remote Controller.

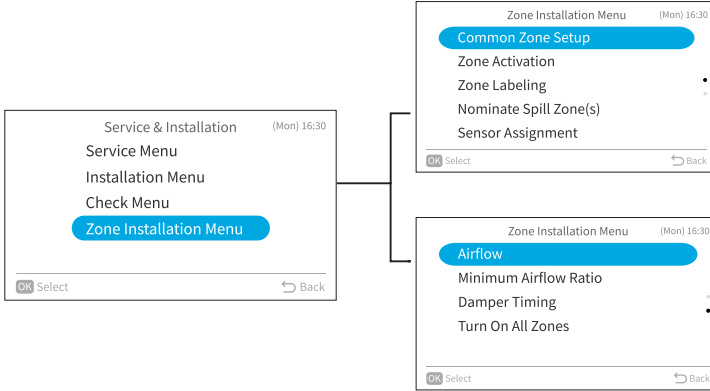

NOTICE

The total airflow ratio of common zone and spill zone(s) shall not be less than the Minimum Airflow Ratio.

(1) Common Zone Setup

Sets whether a common zone is used. A common zone is one that does not have a damper or damper motor installed and whenever the air conditioning system is operated, this zone is always on.

Layout 1 (With common zone)

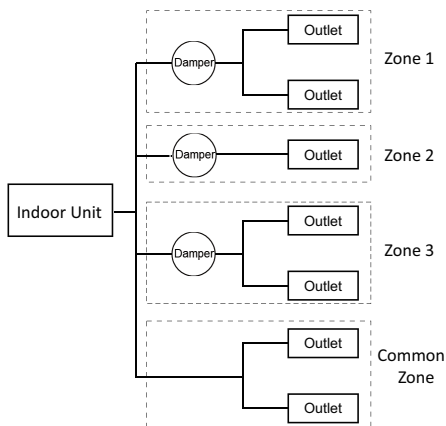

Figure7.1 Zoning Application with Common Zone

Layout 2 (Without common zone)

All the zones are installed with electrical dampers, and can be opened or closed freely.

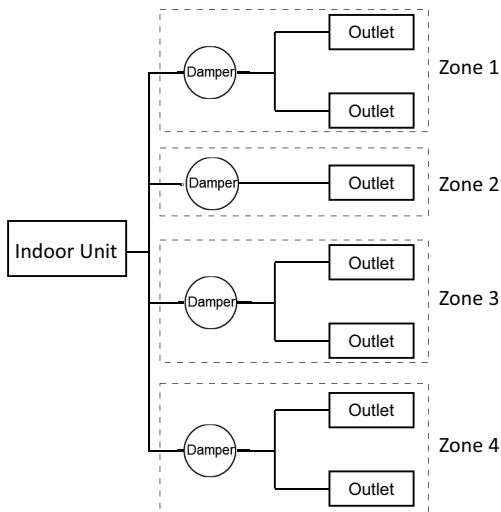

Figure7.2 Zoning Application without Common Zone

NOTE:

- When "common zone setup" is not set, "⊗" are displayed for other setting items and they cannot be set.

(2) Zone Activation

Zone activation is required to set the number of zone that will be used, and to activate the respective zone motor terminals on the zone interface box.

NOTE:

- When “common zone setup” has been set but “zone activation” has not been set, "☹" is displayed for other setting items after “Zone Labeling”.

(3) Zone Labeling

Personalise each zone and link the available sensors to suit the installation layout and usage.

(4) Nominate Spill Zone(s)

Nominate which zone(s) to be spill zone(s). If common zone is not available, at least one spill zone should be nominated. Spill zone1-3 should be set to different zones.

(5) Sensor Assignment

Assign the temperature sensors to each zone for better zone room temperature control. One zone needs to be assigned at least one sensor or thermostat. Multiple sensors can be assigned to the same zone.

(6) Airflow

Set the designed airflow of each enabled zone and common zone (if available).

(7) Minimum Airflow Ratio

Set the minimum airflow ratio of Indoor Unit. The ratio is specified in this manual "2.4 Compatible Air Conditioning Unit".

(8) Damper Timing

Set the time of the damper from fully open to fully close. The supported setting range is from 6 seconds to 150 seconds. All damper timings must be the same.

To calculate damper timing from damper RPM (revolutions per minute), damper timing = $0.25 \times (60 \text{ seconds} / \text{RPM})$. For example, if the damper motor RPM is 1, then damper timing = $0.25 \times (60 \text{ secs} / 1 \text{ RPM}) = 15 \text{ seconds}$. However, we strongly suggest to verify the actual timing in field test.

7.1.2 Zone Configuration Setting from Wired Remote Controller

The Wired Remote Controller model compatible with the Zone Interface Box is PC-ARFG2-Z.

The Wired Remote Controller installation setting steps are as follows.

Zone Installation Menu

If the wired controller is connected to the zone interface box, "Zone Installation Menu" is displayed in "Service & Installation Menu".

Step1. Select "Zone Installation Menu" and press "OK".

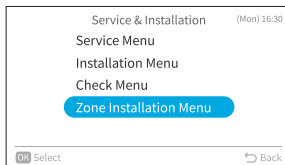

NOTES:

- When "common zone setup" is not set, "⊗" are displayed for other setting items and they cannot be set.
- When "common zone setup" has been set, but "zone activation" has not been set, "⊗" are displayed for other setting items after "Zone Labeling".

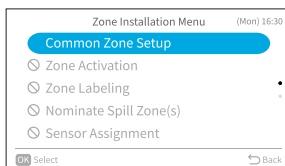

7.1.2.1 Common Zone Setup

A common zone is one that does not have a damper and damper motor installed. Whenever the air conditioning system is operated, this zone is always ON. Refer to Installation and Maintenance Manual of Zone Interface Box for detailed information.

Step1. Select "Common Zone Setup" and press "OK".

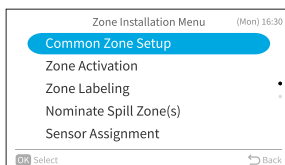

Step2. Press "OK".

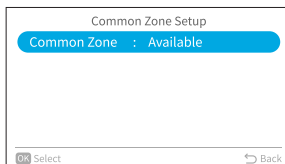

Step3. Press "∧" or "∨" to select the setting and press "OK".

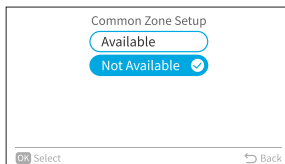

Step4. Press "↵" to return to Zone Installation Menu.

7.1.2.2 Zone Activation

This function is to enable or disable zone from zone1 to zone8.

Step1. Select "Zone Activation" and press "OK".

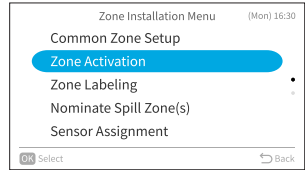

Step2. Press "^" or "v" to select zone, press "<" to set to "Activate", press ">" to set to "None".

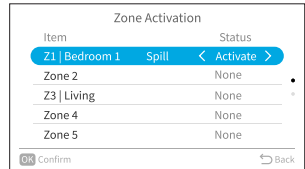

Step3. Press "OK" to save the setting and return to Zone Installation Menu. Or press "↶" to return to Zone Installation Menu without saving the setting.

NOTE:

- The spill zone cannot be set to "None", the spill zone need to be cancelled first.

7.1.2.3 Zone Labeling

This function is to personalize the naming of zones and sensors.

Step1. Select "Zone Labeling" and press "OK".

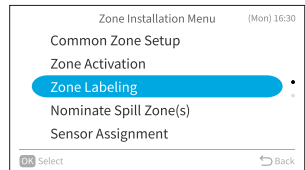

Step2. Press "^" or "v" to select zone and press "OK".

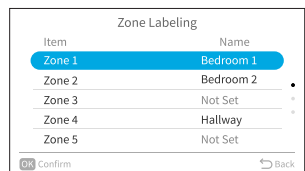

Step3. Press "<" to move cursor to font type.
 Press "^" or "v" to select the font type.
 *Each time you want to change the font type, press "<" to move the cursor back to font type.
 *" has a list of 12 typical zone names pre-entered, the name will appear in the input box directly once the one is selected.

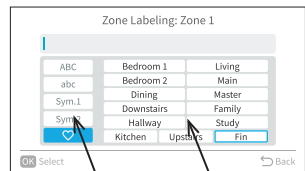

Font type

Keypad

Step4. Press ">" to move the cursor to the keypad.
 Press "^", "v", "<", or ">" to select the font and press "OK". (Up to 12 characters can be used for zone labelling.)

Step5. After all the characters have been set, select " and press "OK".

Step6. The confirmation screen is displayed.
 Select "Yes" and press "OK" to confirm the settings
 and Step2 is displayed.

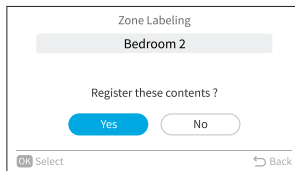

7.1.2.4 Nominate Spill Zone(s)

Step1. Select "Nominate Spill Zone(s)" and press "OK".

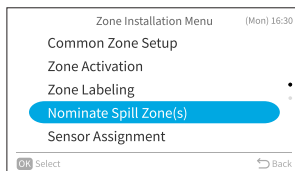

Step2. Press "▲" or "▼" to select spill zone.
 Press "<" or ">" to select zone.

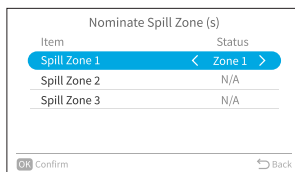

Step3. Press "OK" to save the setting and return to
 Zone Installation Menu. Or press "↵" to return
 to Zone Installation Menu without saving the setting.

NOTES:

- If common zone is not available, at least one spill zone should be nominated.
- Spill Zone1-3 should be set to different zones.

INSTALLATION & MAINTENANCE MANUAL

7.1.2.5 Sensor Assignment

This function is to assign the specified sensor to the activated zone.

Step1. Select "Sensor Assignment" and press "OK".

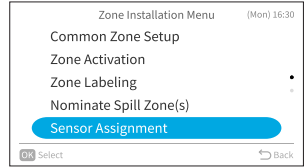

Step2. Press "^" or "v" to select sensor.
Press "<" or ">" to assign sensor to the target zone.

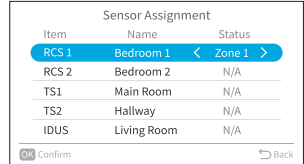

Step3. Press "OK" to save the setting and return to Zone Installation Menu. Or press "⏪" to return to Zone Installation Menu without saving the setting.

NOTES:

- Sensor name and description

Sensor Name	Description
RCS1	Temperature Sensor of primary WRC
RCS2	Temperature Sensor of secondary WRC (optional)
TS1	Remote Sensor 1 connected to ZIB (THM2, optional)
TS2	Remote Sensor 2 connected to ZIB (THM3, optional)
IDUS	Inlet Air Temperature Thermistor of IDU

- If only one wired remote controller is connected or Wi-Fi adapter is connected, sensor "RCS2" will not be displayed.
- Multiple sensors can be assigned to one zone.

7.1.2.6 Airflow

This function is to set the airflow value for each activated zone and common zone(if available).

Step1. Select "Airflow" and press "OK".

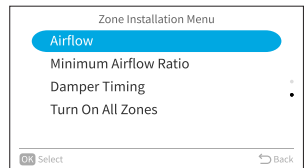

Step2. Press "^" or "v" to select zone and press "OK" to Step3.
Or press "⏪" to return Zone Installation Menu.

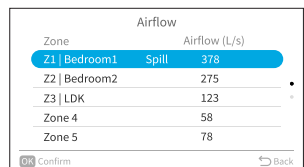

Step3. Press "<" or ">" to select the item.
Press "^" or "v" to set value(unit: L/s).

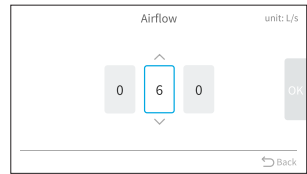

Step4. Select "OK" and press "OK" to save the setting and return to Step2. Or press "↶" to return to Step2 without saving the setting.

7.1.2.7 Minimum Airflow Ratio

Step1. Select "Minimum Airflow Ratio" and press "OK".

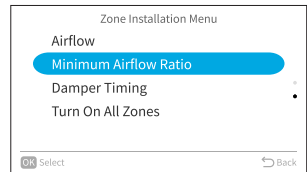

Step2. Press "<" or ">" to select the item.
Press "^" or "v" to set value.

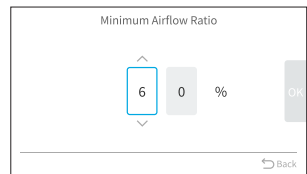

Step3. Select "OK" and press "OK" to save the setting and return to Zone Installation Menu.
Or press "↶" to return to Zone Installation Menu without saving the setting.

NOTE:

- The value range of Minimum Airflow Ratio is 01~99(%).

7.1.2.8 Damper Timing

Step1. Select "Damper Timing" and press "OK".

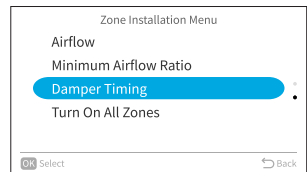

Step2. Press "<" or ">" to select the item.
Press "^" or "v" to set value(unit: Sec.).

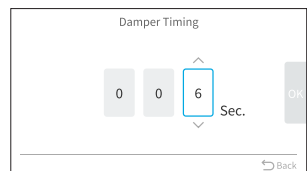

Step3. Select "OK" and press "OK" to save the setting and return to Zone Installation Menu.
Or press "↶" to return to Zone Installation Menu without saving the setting.

NOTE:

- The value range of Damper Timing is 006~150(Sec.).

7.1.2.9 Turn on All Zones

This function is to turn on all the activated zones at the same time.

Step1. Select "Turn on All Zones" and press "OK".

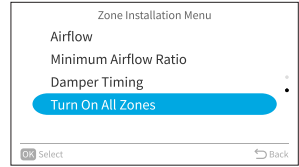

Step2. Press "<" or ">" to select to select "Yes" or "No", and press "OK" to return to Zone Installation Menu.

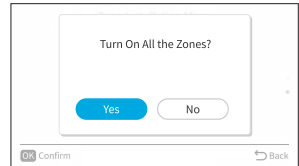

7.1.2.10 Check for Zoning Kit

This function is to display various statuses of the air conditioner.

Step1. Select "Check Menu" on "Service & Installation Menu" and press "OK".

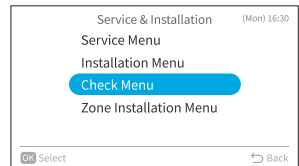

Step2. Select check item in table below and press "OK".

Step3. Select "Zoning Kit" and press "OK".

Item	Function
Check 1 (zoning kit)	Sensor condition of zoning kit are monitored and displayed.
Alarm History Display (zoning kit)	Previous alarm history data of zoning kit is displayed (Max 30). The alarm history can be deleted.
Check PCB of the Units (zoning kit)	The result and diagnosis of ZIB's PCB check is displayed.

7.1.3 Pairing of the Thermostat

7.1.3.1 Pairing Screen



Figure7.1



Figure7.2

- (1) If the thermostat has not been previously paired to a zone, then the screen display shows "00" in the top right hand corner of the display (Figure 7.1). If this is the case, then the thermostat needs to be paired to a zone by following the steps in "7.1.3.2 Pairing Process".
- (2) If the thermostat has been previously paired, then the controller will automatically pick up the paired zone and the zone number will be displayed on the top right hand side of the display (example - Figure 7.2 paired to zone 8)
- (3) If the controller has been wired to the Zone Interface Box and has been previously paired, but does not display correctly, then it may need to be paired again. In this case press and hold "🌀" and "🌞" for 3 seconds to re-enter the pairing screen and follow the steps below in "7.1.3.2 Pairing Process".

7.1.3.2 Pairing Process

Press "▲" or "▼" on the pairing screen to select zone (the already paired Zone ID is not displayed), and then press "🌀" to pair, enter the main screen. The following is an example of the pairing process:

- (1) As shown in Figure7.3, the thermostat has not been paired to any zone. The user can select zone2 ("🏠" indicates that zone2 is enabled), and then press "🌀" to pair thermostat to this zone, and change to the main screen as Figure7.4 displays.



Figure7.3



Figure7.4

- (2) As shown in Figure7.5, the thermostat has been paired to zone2. The user can select zone6 ("06" indicates that zone6 is enabled), and then press "🌀" to change the pairing to zone6 and change to the main screen as Figure7.6.



Figure7.5



Figure7.6

- (3) If for whatever reason the thermostat needs to be unpaired with a zone, enter the pairing mode again and set the zone number to "00".



Figure7.7



Figure7.8

7.2 Indoor Unit Configuration Setting

(1) Temperature control

NOTICE

Please change the value of Function Selection **C8** (Sensor selection for indoor temp. control) to **01**. This setting is required for the room temperatures to be sensed from the individual thermostats or sensors.

The detailed setting steps of c8-01 are as follows:

Function Selection

Function Selection is set from Installation Menu of the Wired Remote Controller.

Step1. Select "Installation Menu" and press "OK".

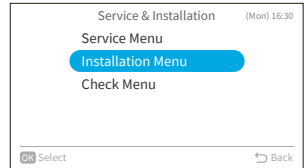

Step2. Select "Function Selection" and press "OK".

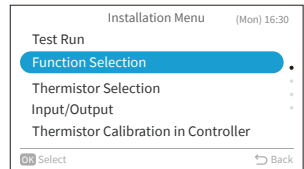

Step3. Press "OK".

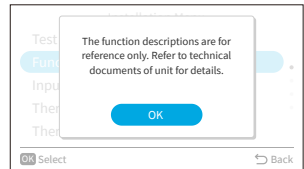

Step4. Press "^" or "v" to select the type tab and press "OK".
→It changes in the order of "b-J" ↔ "K-P" ↔ "q-S" ↔ "☺".

Step5. Press "^", "v", "<", or ">" to select the c8 item to set from the list area. Press "OK" and press "<" or ">" to change the setting value to 01.

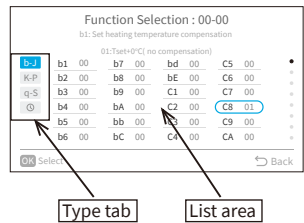

Step6. To confirm the setting, press "☺" in the tab selection mode.

Step7. Select "Yes" and press "OK" to confirm the setting and return to Step2.
Select "No" and press "OK" to discard the settings and return to Step2.
Press "☺" to return to Step5.

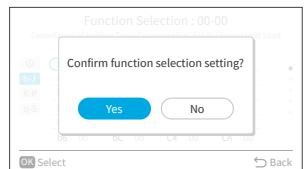

NOTES:

- C8=00 is the factory default setting. If C8 is left unchanged, the system will sense the conditioned space temperature from only one point (i.e.the sensor in the return air) and not from the individual zones as intended.
- If remote temperature sensors are used, they must be plugged into the Zone Interface Box and not into the indoor unit.

(2) Indoor Unit ESP Setting**NOTICE**

Before operating Indoor Unit auto ESP function, please set all zone ON and all zones' airflow tap to H tap first. This can be done using "Turn on All Zones" in Zone Installation Menu.

NOTES:

- Please use auto ESP setting mode or manual ESP setting mode in Indoor Unit ESP setting, and correctly set the ESP value, otherwise zone airflow volume may be influenced.
- Do not operate Indoor Unit auto ESP function when system starting.

7.3 Premium Zoning Kit Notes**(1) Installation related**

- At least one zone must be set enabled.
- Spill zone and common zone are recommended to be installed in public spaces such as living room, corridors or stairs space.
- The damper timing (the time taken for the dampers to move from the fully open to fully closed position and vice-versa) must be the same for all damper motors.
- Each zone (except common zone) must be paired with at least one of the following:
 - One or more room temperature sensors (Indoor Unit Inlet Air Sensor / Primary Wired Remote Controller Sensor / Secondary Wired Remote Controller Sensor / Remote Sensor 1 / Remote Sensor 2)
 - One Thermostat

(2) Function conflict

- To ensure reliable operation of both the air conditioner and zoning kit, please ensure that the function settings below are remain on the factory default setting of 00.

No.	Item	Default Setting
1	b9	00
2	C5	00
3	d5	00
4	EE	00
5	EF	00
6	FA	00
7	K6	00
8	P2	00
9	R1	00

- DSW6-6 of indoor unit PCB is not allowed to be set to ON.

(3) Other notes

- a. When the amount of air through the system is inadequate, the spill zone will automatically open and/or switch the airflow tap to a higher setting. In this situation, the Wired Remote Controller will indicate "Spill Zone Control On" in the display and the spill icon will flash slowly in the thermostat display.
Once the conditions have been satisfied (e.g. additional zones turned on), the spill zone will return to the state it was in previously.
- b. Before setting Test Run mode, please set all zone ON and all zones' airflow to H tap first.
- c. If a zone has Thermostat and other sensors paired simultaneously, there may be a deviation between the room temperature displayed on the Thermostat and on the Wired Remote Controller.
- d. To show the average room temperature of all zones (with cooling/heating demand) on the main screen of wired remote controller, function selection P3 has been set to 02.

8. Test Run

- (1) When all the system configuration settings have been made, set the Air Conditioner mode to fan mode, press the power button on Wired Remote Controller (PC-ARFG2-Z) to turn the Indoor Unit on, and then check the operation of each zone:
 - a. Operate each zone individually and verify that the designed air volume is discharged into the corresponding zone.
 - b. Turn each zone off individually and verify that air is not discharged into the corresponding zone.
- (2) When the operation of all zones has been checked, perform "Turn on All Zones" in the Zone Installation Menu, then refer to the Indoor Unit and Outdoor Unit manuals to start Test Run.

9. Indoor Unit Control

The Wired Remote Controller model supported by the Zone Interface Box is PC-ARFG2-Z. For detailed setting, please refer to the Controller's Operation Manual. Scanning the code can access the web manual.



10. Zone Control

10.1 Zone Control by Wired Remote Controller

The Wired Remote Controller model supported by the Zone Interface Box is PC-ARFG2-Z. See contents below for detailed settings.

If premium zoning kit function is available, "Zone Control" will be displayed on home screen.

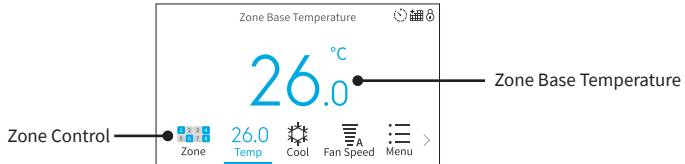

NOTES:

- Zone Control Icon Number indicates the designation of activated zone (zone1~zone8). The color of the grid indicates the status of the zone, with color indicating "ON" and gray indicating "OFF".
- Zone base temperature is used as the base set temperature of zoning kit.
- The set temperature of each zone is limited to $\pm 3^{\circ}\text{C}$ of zone base temperature (within the range of upper and lower limit of the set temperature).

10.1.1 Zone Selection

Step1. Enter zone control menu.

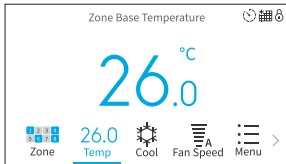

(Air conditioner ON)

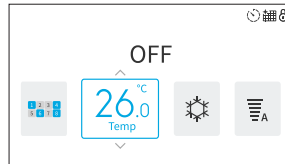

(Air conditioner OFF)

- Press "<" or ">" to select "Zone Control".
- Press "<" or ">" to select "Zone Control" and press "OK".

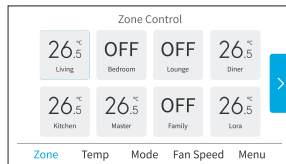

Step2. Press "^", "v", "<", or ">" to select zone and press "OK".

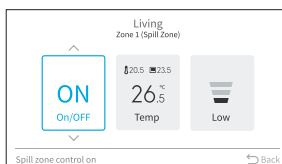

10.1.2 Zone Operation Setting

This function is to set operation (ON/OFF) of individual zone.

Step1. Press "<" or ">" to select "ON/OFF".

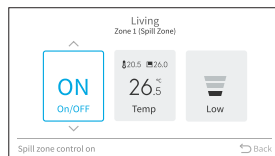

Step2. Press "^" or "v" to set zone operation.



NOTES:

- When "Spill zone control on" displays in the bottom left corner, spill zone enters automatic control, and the actual state of the zone may not be consistent with the set state.
- During Setback operation, Zoning Kit does not accept zone settings. Even if the parameters are modified, they will be restored after one second.

10.1.3 Zone Set Temperature Setting

This function is to adjust "set temperature" of individual zone.

Step1. Press "<" or ">" to select "Temp".

Step2. By pressing "^", the temperature is increased by 0.5°C or 1°C.
By pressing "v", the temperature is decreased by 0.5°C or 1°C.

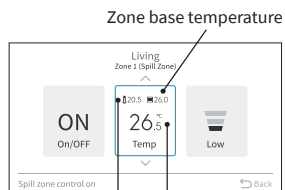

NOTE:

- The set temperature of the zone can be set to $\pm 3^{\circ}\text{C}$ of zone base temperature (within the range of upper and lower limit of the set temperature).

10.1.4 Zone Airflow Tap Setting

This function is to set airflow tap of individual zone.

Step1. Press "<" or ">" to select "Zone Airflow Tap" icon.

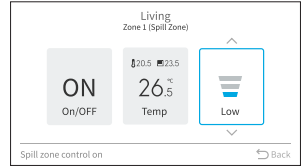

Step2. Press "^" or "v" to set airflow tap of zone.

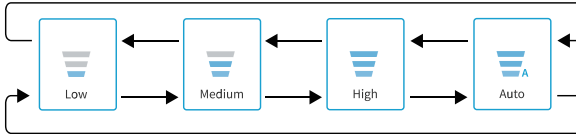

10.1.5 Icon Display for Premium Zone Function

The status for premium zoning kit function is displayed on the home screen.

NOTE:

- If there are multiple status, the high priority icon is displayed first.

No.	Icon	Description
1		The keypad lock is set.
2	System Starting...	The zoning kit is initializing.
3	Zone setup incomplete	The zone installation setup is incomplete.

10.1.6 Zone Schedule

This function is to set the operating schedule of each zone ON/OFF times.

If premium zoning kit has been connected, the zone ON/OFF setting will display on the schedule setting screen.

Step1. Press "<" or ">" to select "Zone" and press "OK".

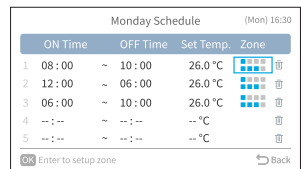

Step2. Press "^" or "v" to set zone.
Press "<" or ">" to set the "ON/OFF" status of each zone.

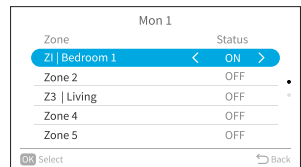

10.1.7 Keypad Lock

This function is to lock all touch key on home screen.

- Activate keypad lock

Press and hold "⏏" until the lock icon 🔒 is displayed.

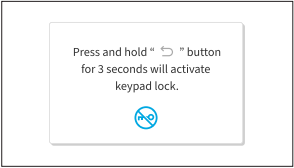

- Deactivate keypad lock

Press and hold "⏏" until the lock icon 🔒 disappears.

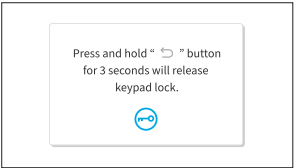

NOTE:

- Keypad lock function only can be activated and deactivated on home screen.

10.1.8 In "Zoning Kit" Alarm Condition

This function is to display the alarm code from zoning kit.



NOTE:

- Prioritize displaying the alarm from indoor unit.

10.2 Zone Control by Thermostat

10.2.1 Thermostat Introduction

Thermostat is a controller installed in each zone to make it easier for users to control and view the zone settings.

The following is the description of panel keys and display icons:



Figure10.1

Icon	Functions	Icon	Functions
	Setback		Room temperature
	Alarm	SET	Set temperature
	Keypad lock	OFF	Zone closed/off
	Enabled zone		Connection status
	Paired zone number		Spill zone
	Zone airflow tap		Timer on/off
	Timer value		Set/Sensor temperature
	Operating mode		

Key	Description	Functions
	ON/OFF	Zone on/off.
	Zone temperature	Display the zone temperature.
	Airflow tap	Set airflow tap
	Timer	Change to timer screen from home screen.
	Up	Increase set values
	Down	Lower set values

NOTES

- If "🔒" (set back mode) displays on the thermostat main screen, the zone switch, temperature, and airflow tap cannot be set.
- If "S" stays lit on the thermostat, this indicates that that zone is set as the spill zone, but spill zone control is not on. When the spill zone control is on, the "S" icon will flash slowly.
- "🔒" display on the main screen or pairing screen indicates that the zone is enabled else is disabled. Please don't pair thermostat to a disabled zone.
- If "🔒" on the main screen or pairing screen blinks every 0.5 seconds, the thermostat is waiting for connection. If "🔒" blinks twice and off for two seconds alternately, the connection to Zone Interface Box is successful but the system configuration is not complete yet and the thermostat can only be paired. If "🔒" stays lit, it indicates that the thermostat and Zone Interface Box are connected, the system configuration is complete and the thermostat is fully functional.

10.2.2 Basic Functions

10.2.2.1 Zone Switch

NOTES:

- Zone Off: The LED above "🔒" is off and "OFF" displays on the screen as Figure10.2.
- Zone On: The LED above "🔒" is on (green) as Figure10.3.
- The "🔒" keypad on thermostat is only used to control the ON/OFF state of the paired zone, not the air conditioning system. If all zones are turned off, the air conditioning system will still continue to run with the spill zone and/or the common zone functioning. To turn the air conditioning system on/off, it must be turned on/off from the wired remote controller with the "🔒" keypad of the Wired Remote Controller.



Figure10.2



Figure10.3

Operation step:

- (1) To turn the zone on, press the "🔒" button, the green LED will turn on.
To turn the zone off, press the "🔒" button, the green LED will turn off.

10.2.2.2 Temperature Setting

NOTES:

- Please refer to Wired Remote Controller Installation Manual for the setting of temperature gradient (0.5°C or 1°C).
- The temperature of each thermostat can be controlled to within $\pm 3^{\circ}\text{C}$ of the temperature that is set on the wired remote controller (PC-ARFG2-Z) main screen.

For example, if the temperature that set on the wired remote controller (PC-ARFG2-Z) main screen is 23°C, then the temperature setting range of the thermostat is:

- the maximum temperature that can be set on each thermostat is 26°C (+3°C).
- the minimum temperature that can be set is 20°C (-3°C).



Figure10.4

Operation step:

Press " ^ " or " v " on the thermostat to select desired temperature. Depending on the temperature gradient selected, the temperature increases or decreases by 0.5°C or 1°C.

10.2.2.3 Setting Airflow Tap



Figure10.5

Operation step:

Press " ⌘ " to change airflow tap as showed in Figure10.5, the airflow tap changes sequentially as shown below.

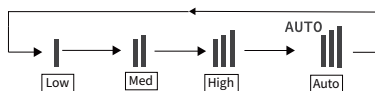

10.2.2.4 Timer Function

NOTE:

- The Timer function allows for the user to set the number of hours for the zone to either be turned on or off.

If the on timer has been set and the zone is manually turned on, then the on timer will deactivate.

Conversely, if the off timer has been set and the zone is manually turned off, then the off timer will deactivate.



Figure10.6



Figure10.7

Operation steps:

- Press "SET" on the main screen to enter the timer setting screen;

NOTE:

- If there is inactivity on the timer setting screen for 10 minutes, it automatically returns to the main screen without saving the set value.
- Press "▲" or "▼" to select the desired countdown time as shown in Figure 10.6;
 - The on or off time ranges from 0.5h to 23h.
 - Press "▲" or "▼" to increase or decrease the number of hours. From 0.5 to 9.5, the time values increase by 0.5 hour increments. From 10 to 23 hours, the time value increases by 1.0 hour increments.
 - Press "OK" to save the set time and return to the main screen; If "OFF" or "POWER" is pressed, the set time will not be saved and it returns to the main screen;
 - After the timer is set, the timer icon and countdown time displays on the main screen as shown in Figure 10.7. The timer time on the main screen updates every half hour indicating the remaining time for the on or off action to be executed.
 - If need to cancel the previous set timer, set the time to 0.0h, then press "OK" to confirm and it return to the main screen.

10.2.2.5 Room Temperature Display



Figure10.8

Operation steps:

- (1) Press "🏠" on the main screen display the zone temperature as shown in Figure 10.8.
- (2) Press "🏠" again or "🔌" on the room temperature display screen to return to the main screen.
 - If there is inactivity on the room temperature display screen for 30 seconds, the system automatically returns to the main screen.

10.2.2.6 Keypad lock



Figure10.9

Operation steps:

- (1) Press and hold "⤴" and "⤵" simultaneously for 3 seconds, the keypad lock function is enabled, and the lock icon "🔒" displays as shown in the Figure10.9.
 - After the lock function is enabled, all the keys on the controller will be inactive except to unlock the keypad.
- (2) To unlock the keypad, press and hold "⤴" and "⤵" simultaneously for 3 seconds. The lock icon "🔒" disappears.

11. Alarm Codes

Alarm code of Zoning Kit

Code	Content of Abnormality	Display
F0	Zone Setting Incomplete	Wired Remote Controller
F1	Abnormal Communication between Wired Remote Controller and Zone Interface Box	Thermostat
F2	Incorrect Thermostat Address Setting	Wired Remote Controller & Thermostat
F3	Abnormality of Primary Wired Remote Controller Sensor	Wired Remote Controller
F4	Abnormality of Secondary Wired Remote Controller Sensor	Wired Remote Controller
F5	Abnormal Communication between Zone Interface Box and Indoor Unit	Thermostat
F6	Abnormality of Remote Sensor 1	Wired Remote Controller
F7	Abnormality of Remote Sensor 2	Wired Remote Controller
E1	Abnormality of Zone 1 Thermostat	Wired Remote Controller or Thermostat
E2	Abnormality of Zone 2 Thermostat	Wired Remote Controller or Thermostat
E3	Abnormality of Zone 3 Thermostat	Wired Remote Controller or Thermostat
E4	Abnormality of Zone 4 Thermostat	Wired Remote Controller or Thermostat
E5	Abnormality of Zone 5 Thermostat	Wired Remote Controller or Thermostat
E6	Abnormality of Zone 6 Thermostat	Wired Remote Controller or Thermostat
E7	Abnormality of Zone 7 Thermostat	Wired Remote Controller or Thermostat
E8	Abnormality of Zone 8 Thermostat	Wired Remote Controller or Thermostat

NOTES:

- If the paired temperature sensor and thermostat of any enabled zone are all defective, the whole system will stop and display an alarm code. Please contact your service agent or repairer to troubleshoot the fault.
- A sensor fault cannot be cleared until it has been fixed.

12. Maintenance and Service

The following table identifies possible troubleshooting solutions for abnormal conditions.

NOTE:

- If Zone Interface Box has been replaced, please complete the configuration according to "7. Field Setting" after replacement.

Item	Phenomenon	Check	Action
1	The zone control menu is not display on the Wired Remote Controller home screen.	Is the power supply turned ON?	Turn ON the power supply.
		Is power wire correctly connected to Zone Interface Box?	Ensure the power wire is correctly connected to Zone Interface Box. Ensure the power wire is turned off to perform wiring work.
		Is power voltage within the applicable range?	Check the voltage on the power supply. Check and rectify if the voltage is out of "normal range" (AC 230V±10%).
		Is communication wire correctly connected to Zone Interface Box?	Correctly connect communication wire to Zone Interface Box.
		Melted fuse or activation of breaker at power supply. Short circuit supplied between wires. Short circuit of wires to earth.	Rectify cause of short circuit and replace fuse.
		Melted fuse for control circuit? Short circuit supplied between wires. Short circuit of wires to earth.	Rectify cause of short circuit and replace fuse or Zone Interface Box.
		Disconnected wire to each PCB.	Correctly connect wires.
	Failure of each PCB.	Replace PCB if faulty.	
2	System starting does not initiate.	Is the power supply for Zone Interface Box normal?	Check the Zone Interface Box power supply and power cable, connect the power cable and power on.
		Is communication wire correctly connected with Zone Interface Box and Wired Remote Controller?	Reconnect communication wire.
		Reboot the system, if still can't solve the problem by 3 times.	Replace the Wired Remote Controller or Zone Interface Box.
3	Alarm code F6 alert (Zoning Kit)	Is remote sensor1 connected well?	Reconnect remote sensor1.
		Is resistance of THM2 between 0.24kΩ and 840kΩ?	Remote sensor 1 has a failure, please replace the remote sensor.
		Failure of PCB.	Replace Zone Interface Box.
	Alarm code F7 alert (Zoning Kit)	Is remote sensor2 connected well?	Reconnect remote sensor2.
		Is resistance of THM3 between 0.24kΩ and 840kΩ?	Remote sensor 2 has a failure, please replace the remote sensor.
		Failure of PCB.	Replace Zone Interface Box.

Item	Phenomenon	Check	Action
4	Zone control menu can display on the Wired Remote Controller home screen normally, but damper does not work or not work properly.	Whether the Zone Interface Box is powered or the communication between Zone Interface Box and Wired Remote Controller is abnormal?	Reset power to the system for 30 seconds or longer. After 3 minutes, check whether the Wired Remote Controller can display the zone control window. If not, please refer to item1 for troubleshooting.
		Any loose of the connection port between main board and relay board?	Check the interface and reconnect.
		Is there proper connection between the zone damper motor and the Zone Interface Box?	Check wiring connection and reconnect.
		Is damper motor faulty?	Please replace damper motor.
		Is the action time (switching time from fully open to fully closed) of all dampers motors consistent?	Please replace damper motor.
		The connected damper motor specification does not meet the requirements of the installation manual.	Please select the correct damper motor.
		Is the damper interface on the relay board shorted?	Relay board failure, please replace Zone Interface Box.
		Is the relay input voltage normal?	Main board failure, please replace Zone Interface Box.
		Is the output voltage of the detection relay normal under normal transformer output?	Relay board failure, please replace Zone Interface Box.
		Check if the input and output ports of the transformer are loose or damaged?	Reconnect the transformer input and output ports or replace Zone Interface Box.
		Is the transformer output port detected 24V?	If the input voltage is normal, no output voltage indicates that the transformer is damaged, replace Zone Interface Box.
5	Thermostat screen is blank and cannot be operated.	Is the power supply turned ON?	Turn ON the power supply.
		Is power wire correctly connected to Zone Interface Box?	Ensure the power wire is correctly connected to Zone Interface Box. Ensure the power wire is turned off to perform wiring work.
		Is power voltage within the applicable range?	Check the voltage on the power supply. Check and rectify if the voltage is out of "normal range" (AC 230V±10%).
		Is communication wire correctly connected to Zone Interface Box?	Correctly connect communication wire to Zone Interface Box.
		Melted fuse or activation of breaker at power supply. Short circuit supplied between wires. Short circuit of wires to earth.	Rectify cause of short circuit and replace fuse.
		Melted fuse for control circuit? Short circuit supplied between wires. Short circuit of wires to earth.	Rectify cause of short circuit and replace fuse or Zone Interface Box.
		Disconnected wire to each PCB. Failure of each PCB.	Correctly connect wires. Replace PCB if faulty.



1186086

Hitachi-Johnson Controls Air Conditioning, Inc.

Add: 1-16-1, Kaigan Minato-ku, Tokyo, Japan

Specifications in this catalogue are subject to change without notice, in order that Hitachi-Johnson Controls may bring the latest innovations to customers.

P02154Q 2023.09 V00 Printed in China