

HITACHI

—
**INSTALLATION
&
MAINTENANCE MANUAL**

—
**Advanced Color
Wired Remote Controller**

airPoint Room 700

MODEL
PC-ARFG2-Z



ORIGINAL INSTRUCTIONS

Cooling & Heating

air

A16381H9HF

Important Notice

- Johnson Controls-Hitachi Air Conditioning pursues a policy of continuing improvement in design and performance in its products. As such, Johnson Controls-Hitachi Air Conditioning reserves the right to make changes at any time without prior notice.
- Johnson Controls-Hitachi Air Conditioning cannot anticipate every possible circumstance that might involve a potential hazard.
- This wired remote controller is designed for human comfort air conditioning applications only. Do not use this wired remote controller for anything other than the purposes for which it was intended for.
- If you have questions, please contact your distributor or dealer.
- Please read this manual carefully before using the product and file it for future reference.

Product Inspection upon Arrival



1. Upon receiving this product, inspect it for any damages incurred in transit. Claims for damage, either apparent or concealed, should be filed immediately with the shipping company.
2. Check the model number, electrical characteristics (power supply, voltage, and frequency rating), and any accessories to determine if they meet the requirements of the installation.
3. The standard utilization for this unit is explained in these instructions. Use of this equipment for purposes other than what it designed for is not recommended.
4. Please contact your installer or local service agent to discuss any issues involving installation, performance or maintenance.
5. Liability does not cover defects originating from unauthorized modifications performed by a customer without the written consent of Johnson Controls-Hitachi Air Conditioning. Performing any mechanical alterations on this product without the consent of the manufacturer renders your warranty null and void.

Table of Contents

| | |
|--|----|
| 1. Safety Summary | 1 |
| 2. Installation Work | 4 |
| 3. Electrical Wiring..... | 6 |
| 4. Entering Service & Installation | 7 |
| 5. Test Run | 8 |
| 6. Function Selection | 9 |
| 7. Input/Output Setting | 21 |
| 8. Main Remote Setting..... | 22 |
| 9. Priority Setting | 24 |
| 10. FrostWash | 25 |
| 11. Setback Trigger Unit | 26 |
| 12. Operation Lock/Unlock Setting | 27 |
| 13. Password Setting | 28 |
| 14. Hotel Mode Setting | 29 |
| 15. Power Saving Details Setting | 30 |
| 16. Temperature Range Restriction | 33 |
| 17. Dual Setpoint Setting..... | 33 |
| 18. Main/Sub Display Setting..... | 34 |
| 19. Room Name Setting | 34 |
| 20. Contact Information Registration | 35 |
| 21. NFC Function | 36 |
| 22. Backup System Setting..... | 38 |
| 22.1 Backup System Setting Items | 40 |
| 22.2 Set Backup System | 41 |
| 23. Adjusting Date/Time | 43 |
| 24. Check Menu | 43 |
| 25. ESP Setting | 44 |
| 26. Premium Zoning Function | 48 |
| 26.1 Zone Installation Menu | 48 |
| 26.2 Check for Zoning Kit | 53 |
| 26.3 Features Not Available When Connected with Zoning Kit | 53 |

1. Safety Summary

Signal Words

| | |
|--|---|
|  WARNING | Indicates a hazardous situation that, if not avoided, could result in death or serious injury. |
|  CAUTION | Indicates a hazardous situation that, if not avoided, could result in minor or moderate injury. |
| NOTICE | Indicates information considered important, but not hazard-related (for example, messages relating to property damage). |

General Precautions

| | |
|--|--|
|  WARNING | To reduce the risk of serious injury or death, read these instructions thoroughly and follow all warnings or cautions included in all manuals that accompanied the product and are attached to the unit. <i>Refer back to these safety instructions as needed.</i> |
|--|--|

- This system, including this controller, should be installed by qualified personnel according to local, state and national building and safety codes and regulations. Incorrect installation could cause leaks, electric shock, fire or an explosion. In areas where Seismic Performance requirements are specified, the appropriate measures should be taken during installation to guard against possible damage or injury that might occur in an earthquake. If the unit is not installed appropriately, injuries may occur because of a falling unit.
- Use appropriate Personal Protective Equipment (PPE), such as gloves, protective goggles and electrical protection equipment and tools suited for electrical installation purposes.
- When transporting, be careful when picking up, moving and mounting these units. Although the controller may be packed using plastic straps, do not use them for transporting from one location to another. Do not stand on or put any material on the controller.
- When connecting the controller cabling to the units, do not touch or adjust any safety devices inside the indoor or outdoor units. All safety features, disengagement, and interlocks must be in place and functioning correctly before the equipment is put into operation. If these devices are improperly adjusted or tampered with in any way, a serious accident can occur. Never bypass, or short-out any safety device or switch.
- Use only Johnson Controls-Hitachi Air Conditioning genuine replacement parts.
- Johnson Controls-Hitachi Air Conditioning will not assume any liability for injuries or damage caused by not following steps outlined or described in this manual. Unauthorized modifications to Johnson Controls-Hitachi Air Conditioning products are prohibited as they:
 - May create hazards which could result in death, serious injury or equipment damage;
 - Will void product warranties;
 - May invalidate product regulatory certifications.

NOTICE

Take the following precautions to reduce the risk of property damage.

- Do not touch the main circuit board or electronic components in the controller or remote devices. Make sure that dust and/or steam does not accumulate on the circuit board.
- Avoid installing the unit in areas where electromagnetic waves are generated, as Electromagnetic interference (EMI) may cause the equipment to malfunction. Do not install where the waves can directly radiate into the electrical box, controller cable, or controller. The operation of the unit may also adversely affect these same devices. Install the unit at least 10 ft. (approximately 3m) away from such devices.
- If the wired remote controller is installed in a location where electromagnetic energy is generated, make sure that the wired remote controller is shielded and cables are run inside conduit tubing.
- If there is a source of electrical interference near the power source, install noise suppression equipment (filter).
- During the test run, check the unit's operation temperature. If the unit is used in an environment where the temperature exceeds the operation limits, it may cause severe damage. Check the operation temperature limits in the manual. If there is no specified temperature, install the unit in a location where the temperature limits are between 0°C to 40°C.
- This manual must be read in conjunction with the installation and operation manuals of other equipment being installed to get a full understanding of the equipment and installation related topics.

Installation Precautions

! WARNING

Take the following precautions to reduce the risk of electric shock, fire or explosion resulting in serious injury or death:

- When using the wired remote controller with the built-in temperature sensor, do not install this controller:
 - Where the controller is exposed to direct sunshine.
 - Where the unit is in close proximity to a heat source which will influence the accuracy of temperature control.
 - Where hot/cold air from the outdoors, or a draft from elsewhere (such as air vents, diffusers, or grilles) can influence the accuracy of the detection of the actual room temperature.
- Perform a test run using the controller to ensure normal operation.

After installation work for the system has been completed, explain the "Safety Precautions" use, and maintenance of the unit to the customer according to the information in all manuals that accompanied the system. All manuals and warranty information must be given to the end user for safe keeping and future reference.

1. Safety Summary

Electrical Precautions



Take the following precautions to reduce the risk of electric shock, fire or explosion resulting in serious injury or death:



- Only use electrical protection equipment and tools suited for this installation.
- Insulate the wired remote controller against moisture and temperature extremes.
- Use specified cables between units and the controller.
- If the power cord is damaged, it must be replaced immediately by a suitably qualified tradesperson.
- Communication cabling must be a minimum of 18-Gauge, twin core stranded copper cable. Shielded cable must be considered for applications in areas of high EMI and other sources of potentially excessive electrical noise to reduce the potential for communication errors. When shielded cabling is applied, proper bonding and termination of the cable shield is required as per Johnson Controls-Hitachi Air Conditioning guidelines. Plenum and riser ratings for communication cables must be considered per application and local code requirements.
- The polarity of the input terminals is important, so be sure to match the polarity when using contacts that have polarity.
- Highly dangerous electrical voltages may be used in this system. Carefully refer to the wiring diagram and these instructions when wiring. Improper connections and inadequate grounding can cause serious injury or death.
- Before installing the controller or remote devices, ensure that the system has been turned off, and after five minutes, power supply to the entire system has been isolated. This is to ensure that the system has undergone and completed its proper shut-down process.
- Do not open the service cover or access panel to the indoor or outdoor units without turning OFF the main power supply. Before connecting or servicing the controller or cables to indoor or outdoor units, open and tag all disconnect switches. Never assume electrical power is disconnected. Verify with a meter and equipment.
- Clamp electrical wires securely with a cable ties after all wiring has been completed. In addition, run wires securely through the wiring access channel.
- Secure the suspended cables at regular intervals, but not too tightly.
- Make sure that the terminals do not come into contact with the surface of the electrical box. If the terminals are too close to the surface, it may lead to failures at the terminal connection.
- Avoid moisture ingress on to and in to the controller as it could cause electric shock and/or damage the unit. Do not use strong detergent such as a solvent. Clean with a soft cloth.

2. Installation Work

This manual is applied for common use of the wired remote controller (connected in non-zoning or zoning system). Refer to "Installation Work" of INSTALLATION & MAINTENANCE MANUAL of Premium Zoning Kit when connected in Zoning system.

[Before Installation]

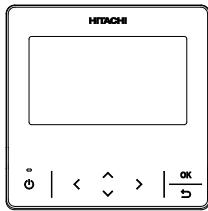
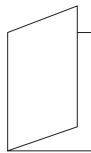
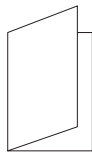
(1) This packing contains the following parts.

| Name | PC-ARFG2-Z | Operation Manual | Installation & Maintenance Manual | Screw |
|------------|---|---|---|--|
| Appearance |  |  |  |  M4 x 16mm |
| Qty. | 1 | 1 | 1 | 2 |

(2) When installing two controllers one above the other, allow a gap of at least 50mm between the two.

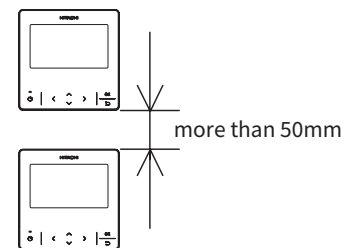

[Installation Procedures]

(1) Insert the edge of the slotted screwdriver into the groove at the bottom of the holding bracket, push and turn the slotted screwdriver to separate and remove the controller from the mounting plate.

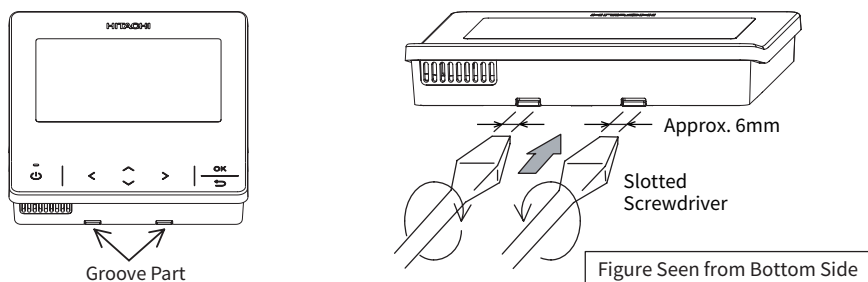

NOTE:

- Do not insert the slotted screwdriver into the tab beside the groove. The tab may be damaged and the advanced color wired remote controller cannot be installed.

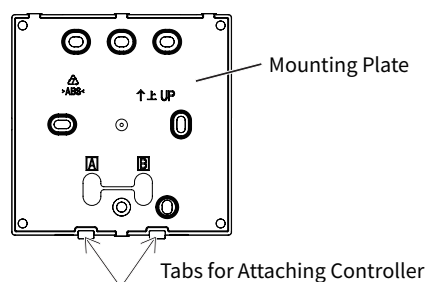

2. Installation Work

- (2) According to different controller installation methods, choose one of the following two ways to install the mounting plate and connect the cable .

Method 1 : To mount the controller directly on the surface of a wall:

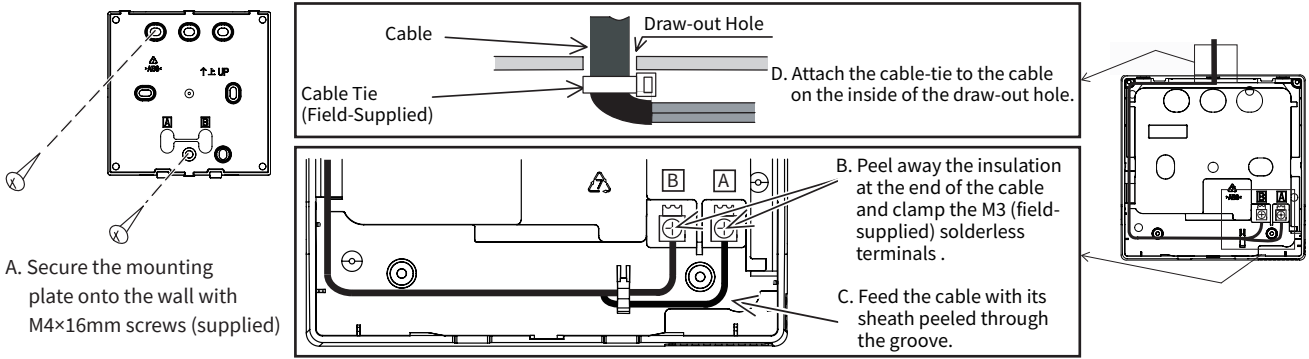

Method 2 : to install the controller on a surface mounting box:

- Prepare the optional field-supplied surface mounting box which can fit the mounting plate.
- Feed the cable through the conduit in the wall.

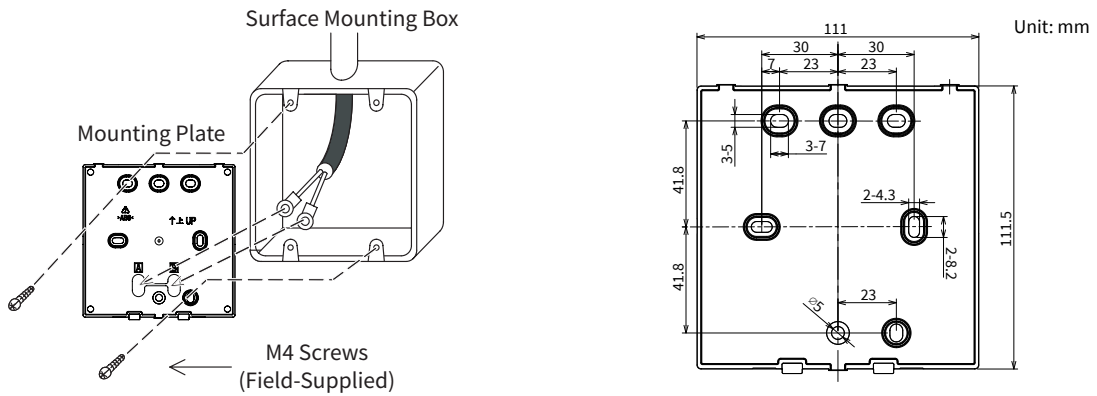

- Cut away the insulation at the end of the cable and clamp the M3 solderless terminals (field-supplied).

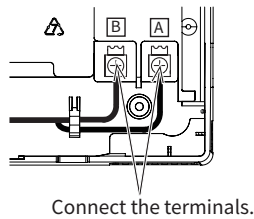

- (3) Re-attach the controller body to the controller mounting plate. Be careful not to pinch the cable when attaching it.

- (4) After installation, remove the protective film from the LCD screen.

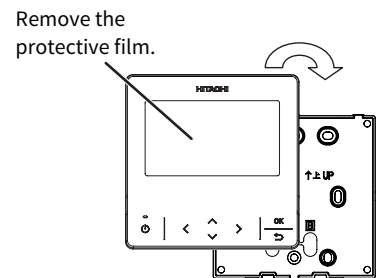

3. Electrical Wiring

Example of communication cable wiring for a non-zoning system:

ATTENTION:

1. Disconnect all power at the main power source before performing electrical work. Failure to do this can result in fire, damage to internal components, and severe or fatal electrical shock.
2. When the wired remote controller is utilized in a zoning system, please refer to "**Electrical Wiring**" of **INSTALLATION & MAINTENANCE MANUAL** of Premium Zoning Kit for guidance.

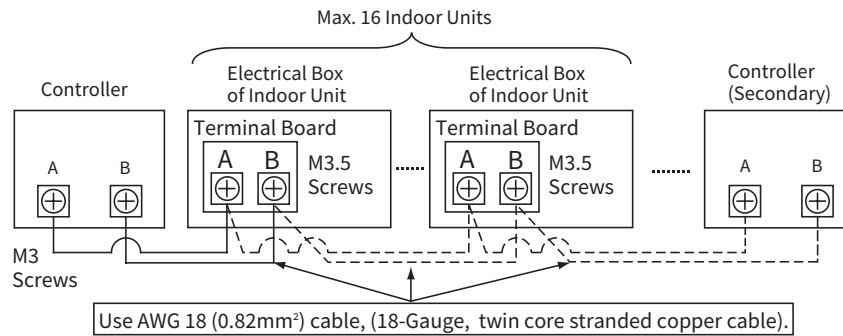

NOTICE

- A. Communication cabling must be a minimum of 18-Gauge, twin core stranded copper cable. Shielded cable must be considered for applications in areas of high electronic interference (EMI) and other sources of potentially excessive electrical noise to reduce the potential for communication errors. When shielded cabling is applied, proper bonding and termination of the cable shield is required as per Johnson Controls-Hitachi Air Conditioning guidelines. Plenum and riser ratings for communication cables must be considered per application and local code requirements. The use of any other grade of cable other than that specified above can result in malfunction from EMI.
- B. Both the controller cable and communication cables between indoor units should maintain a distance for more than 30cm with the power cord of the indoor units. If this is not done, the unit can malfunction due to EMI generated by incoming power cables.
- C. In systems where multiple indoor units are in synchronized control under a single controller, assign the refrigerant cycle numbers and address for indoor units without duplication.
- D. Refer to the "**Unit No. Setting**" of each Installation and Maintenance manual provided with indoor unit when performing electrical wiring work between the controller and indoor units for setting the refrigerant cycle number and the indoor unit address.
- E. No gap should exist between the controller cable and the cable access inlet of the controller box casing. If there is a gap, cover and seal the gap with vinyl tape. Failure to insulate against the penetration of moisture and insects can result in degraded performance and damage to the unit.
- F. If case of operating with two controllers (Primary and Secondary), set the primary and secondary controllers by selecting the appropriate function for those controllers. Refer to Page 12 item F2 in chapter 6. Function Selection. After this is set, reset the power supply to the system.

4. Entering Service & Installation

Some functions are not available when the wired remote controller is connected in Zoning system, please see **26.3 Features Not Available When Connected with Zoning Kit** for details.

Step1. Power On

1. Turn ON the power supply for all the indoor units.
2. For models equipped with an auto-address function, wait approximately 3 minutes.
The controller will go through an initialization process. Please wait till this is completed before making any settings.

Step2. Enter Menu

1. While the air conditioner is OFF, press ">" to scroll across to the "Menu" and press "OK" to display the Menu screen.

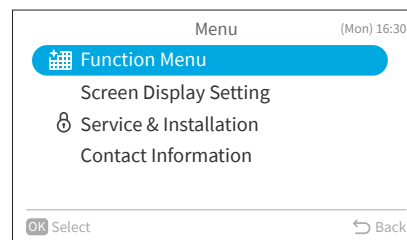

While the air conditioner is ON, press ">" to select "Menu" and display the Menu screen.

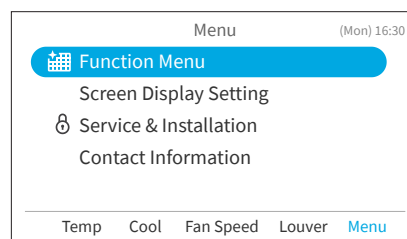

Step3. Select "Service & Installation"

1. Select "Service & Installation" and press "OK".

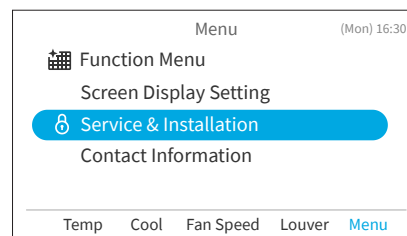

Step4. Input Password

1. Input password by pressing "^", "v", "<", or ">", select "OK".
Then press "OK".
Password is required to prevent unintentional and unauthorised settings.
The default user password is "0000".

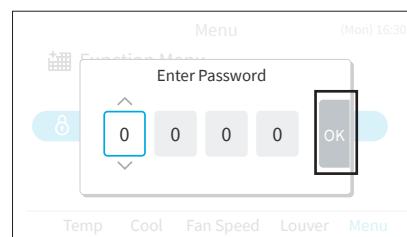

Service & Installation Menu screen is displayed.

If the password input effective time has been set to "Everytime" then the password will need to be entered each time the Service and Installation menu is accessed. If the password input effective time has been set to either 10, 30, 60 or 120 minutes, then the password prompt will not display if accessed within these durations.

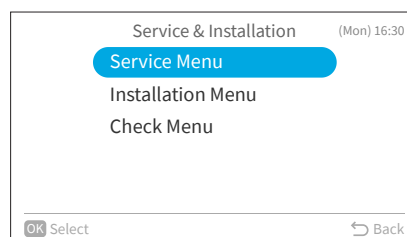

NOTES:

- In order to enhance the security protection, please be sure to change the default password.
- If you enter the wrong password more than 5 times, you will not be able to enter the password within 1 minute.
- Please refer to the manual of the outdoor unit for the service menu "Cool/Heat Auto Changeover".

5. Test Run

Test Run is to run the indoor units whether any pipe or cables is incorrectly installed.

Step1. Enter Installation Menu

1. Select "Installation Menu" and press "OK".

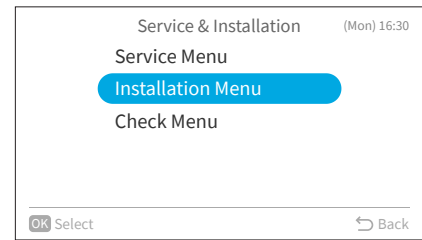

Step2. Enter "Test Run" Mode

1. Select "Test Run" and press "OK".

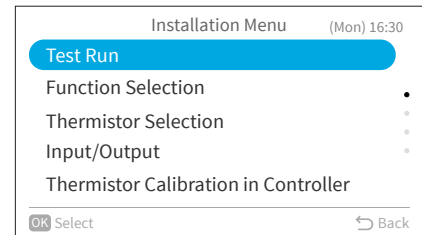

Step3. Test Run

The total number of the indoor units connected is indicated on the screen.

("2 units" is indicated for a twin combination, "3 units" for a triple, and "4 units" for a quad.)

If a number other than a correct number is displayed, the auto-address function does not work properly due to improper wiring or electrical interference and so forth.

Turn OFF the power supply, check the following items and perform the correct connection.

(Do not repeat turning ON and OFF within 10 seconds.)

- The power supply to the indoor unit was not turned ON or there is an incorrect wiring issue.
- There was an incorrect connection issue regarding interconnecting cables between indoor units or of the controller cable.
- There was an incorrect setting of the rotary switch and DIP switches (the settings were overlapped), on the printed circuit board (PCB) for the indoor unit.

NOTE:

When "00" is displayed, the auto-address function may be activated.

Cancel "Test Run" mode and set it again.

- a. Press "⏻" (On/Off) again to activate Test Run.
- b. Press "^", "v", "<", or ">" and set each item.

Step4. Cancel "Test Run" Mode

1. When the unit is not in operation, press "⏻".
2. When the unit is in operation, press "⏻" (On/Off).

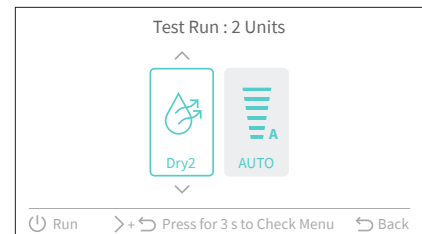

6. Function Selection

Function Selection is set from Installation Menu.

Step1. Select "Installation Menu" and press "OK".

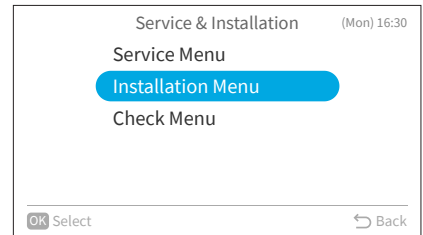

Step2. Select "Function Selection" and press "OK".

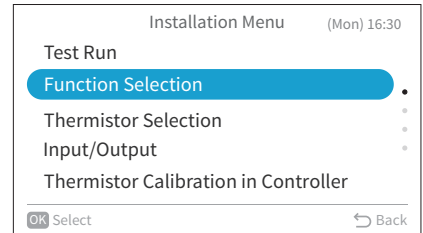

Step3. Press "OK".

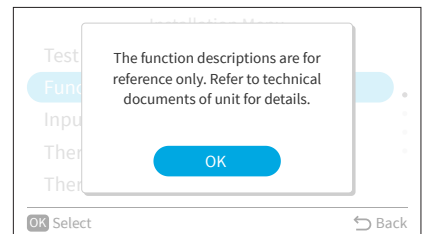

Step4. Press "^", "v", "<", or ">" to select the indoor unit to be set and press "OK".
 This screen is not displayed when only one indoor unit is connected to the wired remote controller. (The screen in Step5 is shown.)

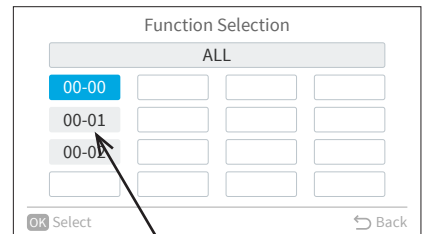

Indoor unit number
 (Refrigerant system number
 —Address number)

Step5. Press "^" or "v" to select the type tab and press "OK".
 →It changes in the order of "b-J" ↔ "K-P" ↔ "q-S" ↔ "⌚".

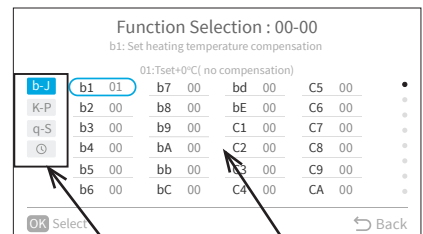

Type tab

List area

Step6. Press "^", "v", "<", or ">" to select the item to set from the list.
 Press "OK" and press "<" or ">" to change the setting value.
 After selecting the setting value, press "↵" to return to the setting item selection mode.
 To return to Step 5, press "↵" in the setting item selection mode.

Step7. To confirm the setting, press "↵" in the tab selection mode.

Step8. Select "Yes" and press "OK" to confirm the setting and return to Step2.
 Select "No" and press "OK" to discard the settings and return to Step2.
 Press "↵" to return to Step5.

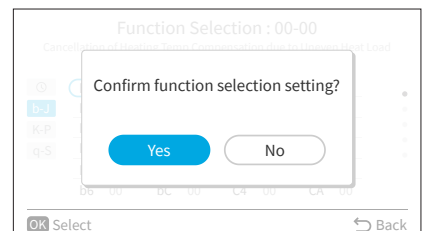

Table A. Optional Setting Items for Function Selection

| No. | Item | Optional Function | Individual Setting | Setting Condition | Contents | Setting |
|-----|------|---|--------------------|----------------------------|---|---------|
| 1 | b1 | Set heating temperature compensation(*1) | ○ | 00 01 02 03 04 | Tset +4°C(default setting)(*2) Tset+0°C(no compensation) Tset+2°C (*3) Tset+3°C Tset+1°C | |
| 2 | b2 | Circulator Function during Heating Thermo-OFF | ○ | 00 01 | Unavailable Available | |
| 3 | b3 | Not used | × | 00 01 | 00 01 | |
| 4 | b4 | Change of filter cleaning period | ○ | 00 01 02 03 04 | 1200h(default setting)(*4) 100h 1200h 2500h No Indication | |
| 5 | b5 | Lock operation mode on controller | × | 00 01 | Usual setting Locked (*5) | |
| 6 | b6 | Lock temperature setting on remote controller | × | 00 01 | Standard Fixed | |
| 7 | b7 | Set operation mode as Cooling Unit | × | 00 01 | Usual setting Locked | |
| 8 | b8 | Automatic Cool/Heat operation | × | 00 01 | Unavailable Available | |
| 9 | b9 | Lock fan speed setting on controller | × | 00 01 | Standard Locked | |
| 10 | bA | Not used | - | - | Not Used(Use as 00 setting conditions) | |
| 11 | bb | Set cooling temperature compensation | × | 00 01 02 | Tset+0°C(no compensation, default setting) Tset-1°C Tset-2°C | |
| 12 | bC | Not used | - | 00 01 | 00 01 | |
| 13 | bd | Not used | - | 00 01 | 00 01 | |
| 14 | bE | Not used | - | 00 01 | 00 01 | |
| 15 | C1 | Not used | - | 00 01 | 00 01 | |
| 16 | C2 | Not used | - | - | Not Used(Use as 00 setting conditions) | |
| 17 | C3 | Not used | - | 00 01 | 00 01 | |
| 18 | C4 | Not used | - | 00 01 | 00 01 | |
| 19 | C5 | Static pressure sel. / Increase Fan Hi speed | ○ | 00 01 02 | Standard static pressure/ Standard speed High static pressure/ Hi speed 1(*6) Low static pressure/ Hi speed 2 | |
| 20 | C6 | Increase of fan speed at heating Thermo-OFF | ○ | 00 01 | Unavailable Available | |
| 21 | C7 | Cancel 3 min. compressor starting delay | ○ | 00 01 | Standard Cancellation | |
| 22 | C8 | Sensor selection for indoor temp. control | ○ | 00 01 02 | Indoor air suction sensor/ average air suction-THM4 Wired controller sensor/ THM4(remote sensor) Average return air sensor and (controller sensor or remote sensor) | |
| 23 | C9 | Not used | - | - | Not Used(Use as 00 setting conditions) | |
| 24 | CA | Not used | - | - | Not Used(Use as 00 setting conditions) | |
| 25 | Cb | Selection of forced stoppage logic | ○ | 00 01 | Normally Open Normally Closed | |
| 26 | CC | Not used | - | 00 01 | 00 01 | |
| 27 | Cd | Not used | - | 00 01 | 00 01 | |
| 28 | CE | Not used | - | 00 01 | 00 01 | |

6. Function Selection

| No. | Item | Optional Function | Individual Setting | Setting Condition | Contents | Setting |
|-----|------|---|--------------------|--|--|---------|
| 29 | CF | Change of Louver Swing Angle | ○ | 00 01 02 | Standard setting (7 steps) Cold draft (5 steps) High ceilings (5 steps) | |
| 30 | d1 | Power Supply ON/OFF 1 | ○ | 00 01 | Unavailable Available | |
| 31 | d2 | Not used | - | - | Not Used(Use as 00 setting conditions) | |
| 32 | d3 | Power Supply ON/OFF 2 | ○ | 00 01 | Unavailable Available | |
| 33 | d4 | Prevention of low air outlet temperature in cooling mode(*7) | ○ | 00 01 | Unavailable Available | |
| 34 | d5 | Prevention of low air outlet temperature in heating mode | ○ | 00 01 | Unavailable Available | |
| 35 | d6 | Not used | - | 00 01 | 00 01 | |
| 36 | d7 | Lower the elevating grille | - | 00 01 02 03 04 05 06 07 | Default setting 100 cm 150 cm 200 cm 250 cm 300 cm 350 cm 400 cm | |
| 37 | E1 | Ventilation Mode(for Total Heat Exchanger) | - | 00 01 02 | AUTO venti./ Disabled/ Standard process THEX venti. Normal venti. | |
| 38 | E2 | Increasing Supply Air Volume(for Total Heat Exchanger) | - | 00 01 | Unavailable Available | |
| 39 | E3 | Not used | - | 00 01 | 00 01 | |
| 40 | E4 | Precooling / Preheating Period(for Total Heat Exchanger) | - | 00 01 02 | Function not available (default setting) 30 min. 60 min. | |
| 41 | E5 | Not used | - | 00 01 | 00 01 | |
| 42 | E6 | Indoor fan operation time after cooling operation stoppage | ○ | 00 01 02 | Unavailable 60 min. 120 min. | |
| 43 | E7 | Not used | - | 00 01 | 00 01 | |
| 44 | E8 | Indoor Unit fan control during heating Thermo-OFF (remote sensor) | ○ | 00 01 | Fan operation is Low speed (default setting) Fan stopped (with remote sensor) or Slow speed (without remote sensor) | |
| 45 | E9 | Not used | - | 00 01 | 00 01 | |
| 46 | EA | Not used | - | 00 01 | 00 01 | |
| 47 | Eb | IU Fan speed during cooling thermo-off | ○ | 00 01 02 | Function deactivated (default setting) Low Slow | |
| 48 | EC | Forced Thermo-ON after cooling operation stop | ○ | 00 01 | Unavailable Available | |
| 49 | Ed | Not used | - | 00 01 | 00 01 | |
| 50 | EE | Automatic Fan Speed Control | ○ | 00 01 | Unavailable Available | |
| 51 | EF | IU fan speed set to Auto allowing High 2 speed | ○ | 00 01 | Unavailable Available | |
| 52 | F0 | Not used | - | - | Not Used(Use as 00 setting conditions) | |

6. Function Selection

| No. | Item | Optional Function | Individual Setting | Setting Condition | Contents | Setting |
|-----|------|--|--------------------|--|---|---------|
| 53 | F1 | Automatic OFF Timer Setting | × | 00 01 02 • • 23 24 0A 0B 0C 0D 0E 0F | No Function 1h 2h 23h 24h 30 min. 90 min. 40 min. 45 min. 50 min. 55 min. } Do not set them when two wired remote controllers are used. | |
| 54 | F2 | Controller primary-secondary setting | × | 00 01 | Primary Secondary | |
| 55 | F3 | Automatic Reset of Setting Temperature (*8) | × | 00 01 | Unavailable Available | |
| 56 | F4 | Automatic Reset Time | × | 00 01 02 03 | 30 min. 15 min. 60 min. 90 min. | |
| 57 | F5 | Automatic Reset Temperature for Cooling (*9) | × | 19 20 21 22 23 24 25 26 27 28 29 30 | 19°C 20°C 21°C 22°C 23°C 24°C 25°C 26°C 27°C 28°C 29°C 30°C | |
| 58 | F6 | Automatic Reset Temperature for Heating (*10) | × | 17 18 19 20 21 22 23 24 25 26 27 28 29 30 | 17°C 18°C 19°C 20°C 21°C 22°C 23°C 24°C 25°C 26°C 27°C 28°C 29°C 30°C | |
| 59 | F7 | Operation stoppage prevention by wired controller operation error(*11) | × | 00 01 | Unavailable Available | |
| 60 | F8 | Lock Function for Operation Mode Selection | × | 00 01 | Unavailable Available | |
| 61 | F9 | Lock Function for Temperature Setting | × | 00 01 | Unavailable Available | |
| 62 | FA | Lock Function for Fan Speed Selection | × | 00 01 | Unavailable Available | |
| 63 | Fb | Lock Function for Swing Louver Operation | × | 00 01 | Unavailable Available | |

6. Function Selection

| No. | Item | Optional Function | Individual Setting | Setting Condition | Contents | Setting |
|-----|------|---|--------------------|-------------------|--|---------|
| 64 | FC | Lower limit for cooling temperature setting (*9) | × | 00 | 19°C (Default setting) | |
| | | | | 01 | 20°C | |
| | | | | 02 | 21°C | |
| | | | | 03 | 22°C | |
| | | | | 04 | 23°C | |
| | | | | 05 | 24°C | |
| | | | | 06 | 25°C | |
| | | | | 07 | 26°C | |
| | | | | 08 | 27°C | |
| | | | | 09 | 28°C | |
| | | | | 10 | 29°C | |
| 65 | Fd | Upper limit for heating temperature setting (*10) | × | 00 | 30°C (Default setting) | |
| | | | | 01 | 29°C | |
| | | | | 02 | 28°C | |
| | | | | 03 | 27°C | |
| | | | | 04 | 26°C | |
| | | | | 05 | 25°C | |
| | | | | 06 | 24°C | |
| | | | | 07 | 23°C | |
| | | | | 08 | 22°C | |
| | | | | 09 | 21°C | |
| | | | | 10 | 20°C | |
| | | | | 11 | 19°C | |
| | | | | 12 | 18°C | |
| 66 | FE | Not used | - | 00 01 | 00 01 | |
| 67 | FF | Not used | - | 00 01 | 00 01 | |
| 68 | H1 | Not used | - | 00 01 | 00 01 | |
| 69 | H2 | Indication of Hot Start | × | 00 01 | Indication No Indication | |
| 70 | H3 | Not used | - | 00 01 | 00 01 | |
| 71 | H4 | Not used | - | 00 01 | 00 01 | |
| 72 | J1 | Not used | - | 00 01 | 00 01 | |
| 73 | J2 | Not used | - | - | Not Used(Use as 00 setting conditions) | |
| 74 | J3 | Run Indicator Color | × | 00 | Green | |
| | | | | 01 | Red | |
| 75 | J4 | Not used | × | 00 | 00 | |
| | | | | 01 | 01 | |
| 76 | J5 | Not used | - | 00 | 00 | |
| | | | | 01 | 01 | |
| 77 | J6 | Error Sound | × | 00 | Once | |
| | | | | 01 | Continuous | |
| 78 | J7 | Not used | × | 00 | 00 | |
| | | | | 01 | 01 | |
| 79 | J8 | Eco-operation (*11) | × | 00 | Unavailable | |
| | | | | 01 | Available | |
| 80 | J9 | Not used | - | 00 | 00 | |
| | | | | 01 | 01 | |
| 81 | JA | Select the Simple Maintenance menu | × | 00 | Unavailable | |
| | | | | 01 | Available | |
| 82 | Jb | Not used | - | 00 | 00 | |
| | | | | 01 | 01 | |

| No. | Item | Optional Function | Individual Setting | Setting Condition | Contents | Setting |
|-----|-------------|--|--------------------|----------------------|--|---------|
| 83 | JC | Calibration for controller temp. sensor | x | 00 | 0°C(0°F) | |
| | | | | 01 | -0.5°C(-1°F) | |
| | | | | 02 | -1.0°C(-2°F) | |
| | | | | 03 | -1.5°C(-3°F) | |
| | | | | 04 | -2.0°C(-3°F) | |
| | | | | 05 | -2.5°C(-4°F) | |
| | | | | 06 | -3.0°C(-5°F) | |
| | | | | 07 | -3.5°C(-6°F) | |
| | | | | 08 | +0.5°C(+1°F) | |
| | | | | 09 | +1.0°C(+2°F) | |
| | | | | 10 | +1.5°C(+3°F) | |
| | | | | 11 | +2.0°C(+3°F) | |
| | | | | 12 | +2.5°C(+4°F) | |
| | | | | 13 | +3.0°C(+5°F) | |
| | | | | 14 | +3.5°C(+6°F) | |
| 15 | 0°C (0°F) | | | | | |
| 84 | Jd | Upper limit for cooling temperature setting | - | 00 | 30°C(86°F) | |
| | | | | 01 | 29°C(84°F) | |
| | | | | 02 | 28°C (82°F) | |
| | | | | 03 | 27°C (80°F) | |
| | | | | 04 | 26°C (78°F) | |
| | | | | 05 | 25°C (77°F) | |
| | | | | 06 | 24°C (76°F) | |
| | | | | 07 | 23°C (74°F) | |
| | | | | 08 | 22°C (72°F) | |
| | | | | 09 | 21°C (70°F) | |
| 10 | 20°C (68°F) | | | | | |
| 85 | JE | Lower limit for heating temperature setting | - | 00 | 17°C (62°F) | |
| | | | | 01 | 18°C (64°F) | |
| | | | | 02 | 19°C (66°F) | |
| | | | | 03 | 20°C (68°F) | |
| | | | | 04 | 21°C (70°F) | |
| | | | | 05 | 22°C (72°F) | |
| | | | | 06 | 23°C (74°F) | |
| | | | | 07 | 24°C (76°F) | |
| | | | | 08 | 25°C (77°F) | |
| | | | | 09 | 26°C (78°F) | |
| | | | | 10 | 27°C (80°F) | |
| | | | | 11 | 28°C (82°F) | |
| 12 | 29°C (84°F) | | | | | |
| 86 | K1 | Not used | - | 00 01 | 00 01 | |
| 87 | K2 | Not used | - | 00 01 | 00 01 | |
| 88 | K3 | Not used | - | 00 01 | 00 01 | |
| 89 | K4 | Not used | - | 00 01 | 00 01 | |
| 90 | K5 | Motion sensor detection level | ○ | 00 01 02 | Standard setting High Low | |
| 91 | K6 | Operation mode selection when IDU control sensor is defined by C8 function | ○ | 00 01 02 03 | ALL COOL/DRY HEAT ALL | |
| 92 | K7 | Radiant Temp. sensor detection level | - | 00 01 02 03 | Default setting Upper Lower Preliminary setting | |
| 93 | K8 | Not used | - | 00 01 | 00 01 | |
| 94 | K9 | Not used | - | 00 01 | 00 01 | |
| 95 | KA | Not used | - | 00 01 | 00 01 | |

6. Function Selection

| No. | Item | Optional Function | Individual Setting | Setting Condition | Contents | Setting |
|-----|------|--|--------------------|----------------------|--|---------|
| 96 | L1 | Setting Position of Motion Sensor | - | 00 01 02 03 | A B -- D | |
| 97 | L2 | Not used | - | 00 01 | 00 01 | |
| 98 | L3 | Select louver operation in energy-saving Th.-OFF (COOL & DRY)(*12) | ○ | 00 01 02 | Low air flow Medium air flow High air flow | |
| 99 | L4 | Fan Speed during Energy-Saving Forced Thermo-OFF | ○ | 00 01 | Usual setting Available | |
| 100 | L5 | Louver Swing Operation Energy-Saving Forced Thermo-OFF | ○ | 00 01 | Unavailable Available | |
| 101 | L6 | Not used | - | 00 01 | 00 01 | |
| 102 | L7 | Not used | - | - | Not Used (Use as 00 setting conditions) | |
| 103 | L8 | Not used | - | 00 01 | 00 01 | |
| 104 | L9 | Not used | - | 00 01 | 00 01 | |
| 105 | LA | Humidifier blow control On/Off | - | 00 01 | Unavailable Available | |
| 106 | Lb | Humidifier blow control time setting | - | 00 01 | 4hours ON 30min OFF 30min ON 10min OFF | |
| 107 | P1 | Setting temperature | × | 00 01 | 0.5°C steps 1°C steps | |
| 108 | P2 | Not used | - | 00 01 | 00 01 | |
| 109 | P3 | Select temperature sensor(*13) | × | 00 01 02 03 | Inlet Air Thermistor Outlet Air Thermistor Thermistor of Wired Controller Remote Sensor | |
| 110 | P4 | Temperature sensor display(*14) | × | 00 01 | Unavailable Available | |
| 111 | P5 | Temperature setting display in fan mode | × | 00 01 | Show Hide | |
| 112 | P6 | Not used | - | 00 01 | 00 01 | |
| 113 | P7 | Menu screen transition prohibited | × | 00 01 | Unavailable Available | |
| 114 | P8 | Maintenance explanation display | × | 00 01 | Available Unavailable | |
| 115 | P9 | Alarm explanation display | × | 00 01 | Available Unavailable | |
| 116 | PA | Daylight Savings Time | × | 00 01 | 00 01 | |
| 117 | Pb | Not used | - | 00 01 | 00 01 | |
| 118 | PC | Not used | - | 00 01 | 00 01 | |
| 119 | q1 | Not used | × | 00 01 | 00 01 | |
| 120 | q2 | Not used | × | 00 01 | 00 01 | |
| 121 | q3 | Not used | × | 00 01 | 00 01 | |
| 122 | q4 | Not used | × | 00 01 | 00 01 | |
| 123 | q5 | Not used | × | 00 01 | 00 01 | |
| 124 | q6 | Not used | × | 00 01 | 00 01 | |
| 125 | q7 | Not used | × | 00 01 | 00 01 | |

6. Function Selection

| No. | Item | Optional Function | Individual Setting | Setting Condition | Contents | Setting |
|-----|------|---|--------------------|--|--|---------|
| 126 | q8 | Not used | - | 00 01 | 00 01 | |
| 127 | q9 | Not used | - | 00 01 | 00 01 | |
| 128 | qA | Not used | - | 00 01 | 00 01 | |
| 129 | qb | Operation mode with Setback | × | 00 01 02 03 | Unavailable COOL only HEAT only COOL & HEAT | |
| 130 | qC | Temp. differential for the Setback operation | × | 00 01 02 03 04 | 2.0°C(3°F) 3.0°C(5°F) 4.0°C(7°F) 5.0°C(9°F) 1.0°C (2°F) | |
| 131 | qd | Minimum stop time of Setback | × | 00 01 02 03 04 05 06 07 08 09 10 11 | 10 min. 20 min. 30 min. 40 min. 50 min. 60 min. 70 min. 80 min. 90 min. 100 min. 110 min. 120 min. | |
| 132 | qE | Setback Mode | × | 00 01 02 03 | Always Input Schedule Manual | |
| 133 | qF | Operation state after Setback operation ends | × | 00 01 02 | Stop Run State before Setback Operation | |
| 134 | r1 | Dual Setpoint | × | 00 01 | Unavailable Available | |
| 135 | r2 | Differential temp. setting for Cooling-Heating changeover | × | 00 01 02 03 04 05 | 1.0°C (2°F)(Default) 1.5°C (3°F) 2.0°C (3°F) 2.5°C (4°F) 3.0°C (5°F) 0.5°C (1°F) | |
| 136 | r3 | Setback Temperature Compensation | × | 05 10 15 20 25 30 35 40 45 50 55 | 0.5°C (1°F) 1.0°C (2°F) 1.5°C (3°F) 2.0°C (3°F) 2.5°C (4°F) 3.0°C (5°F) 3.5°C (6°F) 4.0°C (7°F) 4.5°C (8°F) 5.0°C (9°F) 5.5°C (10°F) | |
| 137 | r4 | Enable/Disable Auto-FrostWash 2 | - | 00 01 | Available Unavailable | |
| 138 | r5 | Not used | - | 00 01 | 00 01 | |
| 139 | r6 | FrostWash Manual Setting | × | 00 01 | Allow Prohibit | |
| 140 | r7 | FrostWash Automatic Setting | × | 00 01 | Allow Prohibit | |
| 141 | r8 | Enable/Disable Auto-FrostWash | × | 00 01 | Disable Enable | |
| 142 | r9 | Remote control prohibition during Setback operation | × | 00 01 02 | Run/Stop allowed Run & Stop not allowed (not advised for safety reasons) Only stop allowed | |

6. Function Selection

| No. | Item | Optional Function | Individual Setting | Setting Condition | Contents | Setting |
|-----|------|---|--------------------|--|---|---------|
| 143 | rA | FrostWash interval settings | × | 00 01 02 03 04 05 06 07 | 100h 200h 400h 50h 100h 100h 100h 100h | |
| 144 | rb | Minimum Cool/Heat Time for Auto Cool/Heat Operation | × | 00 01 02 03 04 05 06 07 08 09 10 11 12 | Unavailable 10 min. 20 min. 30 min. 40 min. 50 min. 60 min. 70 min. 80 min. 90 min. 100 min. 110 min. 120 min. | |
| 145 | rC | Max. outdoor temp. for Heat operation in Auto Cool-Heat Dual Setpoint | × | 00 01 02 03 04 05 06 07 08 09 10 11 12 13 14 15 16 17 18 19 20 21 22 23 24 25 26 27 28 29 30 31 32 33 34 35 36 37 38 39 40 41 | Unavailable 20.0°C (68°F) 21.0°C (70°F) 22.0°C (72°F) 23.0°C (74°F) 24.0°C (75°F) 25.0°C (77°F) 26.0°C (78°F) 27.0°C (80°F) 28.0°C (82°F) 29.0°C (84°F) 30.0°C (86°F) 31.0°C (88°F) 32.0°C (90°F) 33.0°C (92°F) 34.0°C (94°F) 35.0°C (95°F) 36.0°C (96°F) 37.0°C (99°F) 38.0°C (100°F) 39.0°C (102°F) 40.0°C (104°F) 0.0°C (32°F) 1.0°C (34°F) 2.0°C (36°F) 3.0°C (38°F) 4.0°C (40°F) 5.0°C (41°F) 6.0°C (42°F) 7.0°C (44°F) 8.0°C (46°F) 9.0°C (48°F) 10.0°C (50°F) 11.0°C (52°F) 12.0°C (54°F) 13.0°C (56°F) 14.0°C (58°F) 15.0°C (59°F) 16.0°C (61°F) 17.0°C (62°F) 18.0°C (64°F) 19.0°C (66°F) | |

| No. | Item | Optional Function | Individual Setting | Setting Condition | Contents | Setting |
|-----|--------------|---|--------------------|-------------------|----------------|---------|
| 146 | rd | Min. outdoor temp. for Cool operation in Auto Cool-Heat Dual Setpoint | × | 00 | Unavailable | |
| | | | | 01 | 10.0°C (50°F) | |
| | | | | 02 | 11.0°C (52°F) | |
| | | | | 03 | 12.0°C (54°F) | |
| | | | | 04 | 13.0°C (56°F) | |
| | | | | 05 | 14.0°C (58°F) | |
| | | | | 06 | 15.0°C (59°F) | |
| | | | | 07 | 16.0°C (60°F) | |
| | | | | 08 | 17.0°C (62°F) | |
| | | | | 09 | 18.0°C (64°F) | |
| | | | | 10 | 19.0°C (66°F) | |
| | | | | 11 | 20.0°C (68°F) | |
| | | | | 12 | 21.0°C (70°F) | |
| | | | | 13 | 22.0°C (72°F) | |
| | | | | 14 | 23.0°C (74°F) | |
| | | | | 15 | 24.0°C (76°F) | |
| | | | | 16 | 25.0°C (77°F) | |
| | | | | 17 | 26.0°C (78°F) | |
| | | | | 18 | 27.0°C (80°F) | |
| | | | | 19 | 28.0°C (82°F) | |
| | | | | 20 | 29.0°C (84°F) | |
| | | | | 21 | 30.0°C (86°F) | |
| | | | | 22 | 31.0°C (88°F) | |
| | | | | 23 | 32.0°C (90°F) | |
| | | | | 24 | 33.0°C (92°F) | |
| | | | | 25 | 34.0°C (94°F) | |
| | | | | 26 | 35.0°C (95°F) | |
| | | | | 27 | 36.0°C (96°F) | |
| | | | | 28 | 37.0°C (98°F) | |
| | | | | 29 | 38.0°C (100°F) | |
| | | | | 30 | 39.0°C (102°F) | |
| | | | | 31 | 40.0°C (104°F) | |
| | | | | 32 | -20.0°C (-4°F) | |
| | | | | 33 | -19.0°C (-2°F) | |
| | | | | 34 | -18.0°C (0°F) | |
| | | | | 35 | -17.0°C (2°F) | |
| | | | | 36 | -16.0°C (4°F) | |
| | | | | 37 | -15.0°C (5°F) | |
| | | | | 38 | -14.0°C (6°F) | |
| | | | | 39 | -13.0°C (8°F) | |
| | | | | 40 | -12.0°C (10°F) | |
| | | | | 41 | -11.0°C (12°F) | |
| | | | | 42 | -10.0°C (14°F) | |
| | | | | 43 | -9.0°C (16°F) | |
| | | | | 44 | -8.0°C (18°F) | |
| | | | | 45 | -7.0°C (20°F) | |
| | | | | 46 | -6.0°C (22°F) | |
| | | | | 47 | -5.0°C (23°F) | |
| | | | | 48 | -4.0°C (24°F) | |
| | | | | 49 | -3.0°C (26°F) | |
| | | | | 50 | -2.0°C (28°F) | |
| | | | | 51 | -1.0°C (30°F) | |
| | | | | 52 | 0.0°C (32°F) | |
| | | | | 53 | 1.0°C (34°F) | |
| | | | | 54 | 2.0°C (36°F) | |
| | | | | 55 | 3.0°C (38°F) | |
| | | | | 56 | 4.0°C (40°F) | |
| | | | | 57 | 5.0°C (41°F) | |
| | | | | 58 | 6.0°C (42°F) | |
| | | | | 59 | 7.0°C (44°F) | |
| | | | | 60 | 8.0°C (46°F) | |
| 61 | 9.0°C (48°F) | | | | | |

6. Function Selection

| No. | Item | Optional Function | Individual Setting | Setting Condition | Contents | Setting |
|-----|----------|---|--------------------|-------------------|---------------|---------|
| 147 | rE | Setback Activating Temp. for Heat Mode | × | 00 | 15.0°C (59°F) | |
| | | | | 01 | 16.0°C (60°F) | |
| | | | | 02 | 17.0°C (62°F) | |
| | | | | 03 | 18.0°C (64°F) | |
| | | | | 04 | 19.0°C (66°F) | |
| | | | | 05 | 10.0°C (50°F) | |
| | | | | 06 | 11.0°C (52°F) | |
| | | | | 07 | 12.0°C (54°F) | |
| | | | | 08 | 13.0°C (56°F) | |
| | | | | 09 | 14.0°C (58°F) | |
| 148 | rF | Setback Activating Temp. for Cool Mode | × | 00 | 26.0°C (78°F) | |
| | | | | 01 | 27.0°C (80°F) | |
| | | | | 02 | 28.0°C (82°F) | |
| | | | | 03 | 29.0°C (84°F) | |
| | | | | 04 | 30.0°C (86°F) | |
| | | | | 05 | 31.0°C (88°F) | |
| | | | | 06 | 32.0°C (90°F) | |
| | | | | 07 | 33.0°C (92°F) | |
| | | | | 08 | 34.0°C (94°F) | |
| | | | | 09 | 35.0°C (95°F) | |
| | | | | 10 | 25.0°C (77°F) | |
| 149 | S1 (*15) | Econo outside air high humidity control | - | 00 | Unavailable | |
| | | | | 01 | Available | |
| 150 | S2 | 24-hour ventilation control | - | 00 | Unavailable | |
| | | | | 01 | Available | |
| 151 | S3 | NightPurge control | - | 00 | Unavailable | |
| | | | | 01 | Available | |
| 152 | S4 | Fan control based on CO2 sensor | - | 00 | Unavailable | |
| | | | | 01 | Available | |
| 153 | S5 | Rapid ventilation control at the start of operation | - | 00 | Unavailable | |
| | | | | 01 | Available | |
| 154 | S6 | Humidifier drying operation | - | 00 | 90 min | |
| | | | | 01 | 180 min | |
| | | | | 02 | Unavailable | |
| 155 | S7 | Suction humidity level setting | - | 00 | Unavailable | |
| | | | | 01 | High | |
| | | | | 02 | Med | |
| | | | | 03 | Low | |
| 156 | S8 | Suction humidity control setting | - | 00 | Standard | |
| | | | | 01 | High Humidity | |
| | | | | 02 | Low Humidity | |

- (*1): Even if temperature sensor selection is changed through "P3" setting, the compensation value will not be changed automatically. Please change b1 setting according to temperature sensor selection.
- (*2): The default temperature compensation is +2°C for Floor Exposed type & Floor Concealed type.
- (*3): The "02", "03", "04" settings may not be available depending on the type of indoor unit. When connecting multiple indoor units, do separate settings.
- (*4): Standard type.
- (*5): It is not applicable for Auto mode.
- (*6): If Duct type models, 00: Increasing fan speed 1 (standard), 01: Increasing fan speed 2 (high static pressure), 02: Standard (low static pressure).
- (*7): Since it depends on the model, please refer to the Service Manual of each model.
- (*8): If the set temperature is changed and kept within the set time at "F4", the temperature is automatically changed to "F5" and "F6". (If the set temperature is out of range at "F5" and "F6", it is applied within the upper and lower limits for the set temperature.)
- (*9): Applicable to the fan, cooling and dry operation modes.
- (*10): Applicable to the heating operation mode.
- (*11): When the unit is restarted by the controller, the temperature automatically changes to the setting temperature of "F5" or "F6".
- (*12): Available only for 4-Way Cassette Type, 4-Way Cassette Compact Type, 2-Way Cassette Type, 1-Way Cassette Type, Ceiling Type.
- (*13): Setting "P4" to "01", then the temperature of selected thermistor (sensor) can be shown.
- (*14): Setting "01" can show sensor temperature selected in "P3".
- (*15): Items "S1~S8" are available only for new econo-fresh units.

NOTES:

1. Power ON, wait 3 minutes and then change the optional setting.
2. When changing the "CF" setting (changing the louver swing angle), restore the power supply or allow the louver to make one complete swing fully in the auto-swing mode to apply the optional setting.
3. The optional settings may be different according to the indoor and outdoor unit models.
Check to ensure that the unit has the optional setting.
4. Record the setting conditions for each optional setting in the "Setting" column of the table above.
5. The above optional functions marked with an "X" at the individual setting can change the condition only when "All Indoor Units" is set.
6. Up to 24 history records can be saved.
7. The history is initialized when the function selection and the input/output is initialized.

7. Input/Output Setting

Set Input/output from the Installation Menu. Please refer to Table B and Table C for details on each input setting.

1. Set Input/Output

Step1. Select "Installation Menu" on the Service & Installation screen and press "OK" .

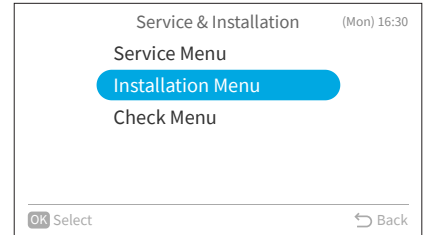

Step2. Select "Input/Output" setting and press "OK".

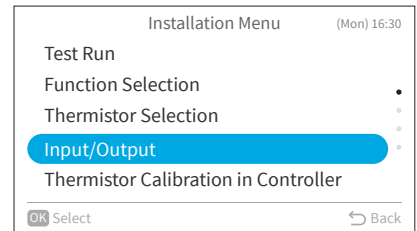

Step3. Press "OK".

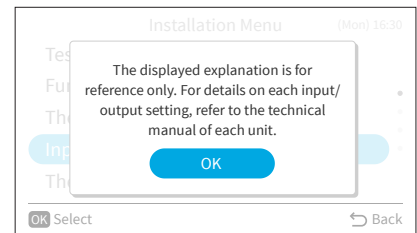

Step4. Select the indoor unit by pressing "^", "v", "<", or ">" and press "OK".
(This screen is NOT displayed when only one indoor unit is connected with the controller. In this case, "Step4" is displayed.)

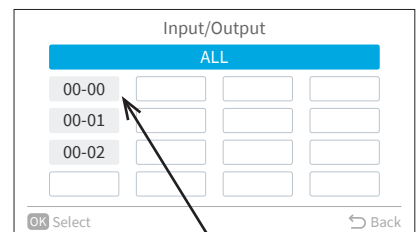

Indoor unit number
(Refrigerant system number
—Address number)

Step5. Press "^" or "v" to select the item.

Step6. Press "<" or ">" to change the setting.

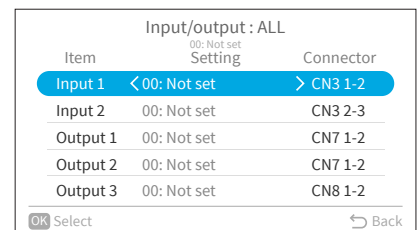

Step7. Press "OK" and the confirmation screen is displayed.

Step8. Select "Yes" and press "OK" to confirm the setting and the screen returns to Step2.

If "Cancel" is selected, the setting is cancelled and the screen returns to Step2.

If there is more than one indoor unit connected to the remote controller, the screen returns to Step3.

Press "↶" to return to Step4.

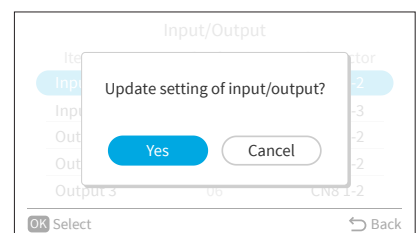

Table B. Input and Output Number Display and Connectors

| Input Number Display Input/Output Indication | Port | Factory Setting | | Setting |
|---|---------|---|------------|---------|
| | | Setting Item | Indication | |
| Input 1 | CN3 1-2 | Remote ON/OFF 1 (Level) | 03 | |
| Input 2 | CN3 2-3 | Forbidding Remote Control after Manual Stoppage | 06 | |
| Output 1 | CN7 1-2 | Operation | 01 | |
| Output 2 | CN7 1-3 | Alarm | 02 | |
| Output 3 | CN8 1-2 | Thermo-ON for Heating | 06 | |

Table C. Input and Output Settings and Display Codes

| Code Indicated | Input | Output |
|----------------|---|-----------------------|
| 00 | Not set | Not set |
| 01 | Room Thermostat (for Cooling) | Operation |
| 02 | Room Thermostat (for Heating) | Alarm |
| 03 | Remote ON/OFF 1 (Level) | Cooling |
| 04 | Remote ON/OFF 2 (Operation) | Thermo-ON for Cooling |
| 05 | Remote ON/OFF 2 (Stoppage) | Heating |
| 06 | Forbidding Remote Control after Manual Stoppage | Thermo-ON for Heating |
| 07 | Remote Cooling / Heating Change | Total Heat Exchanger |
| 08 | Elevate Grille Input | Elevate Grille Output |
| 09 | Setback Operation | Fan Operation |
| 10~15 | Not set | Not set |

NOTES:

- Change the optional setting after waiting at least three minutes elapsed time after start-up.
- Do not set the elevating grille for the total heat exchanger.
- Record the setting conditions for each input and output in the "Setting" column of the table.

8. Main Remote Setting

To change the sub remote controller to the main remote controller.

If multiple remote control groups exist in the same outdoor system, main/sub setting is automatically allocated. Set the desired Wired Remote Controller as the "Main" remote controller.

- Example of a refrigeration system containing a group of multiple controllers

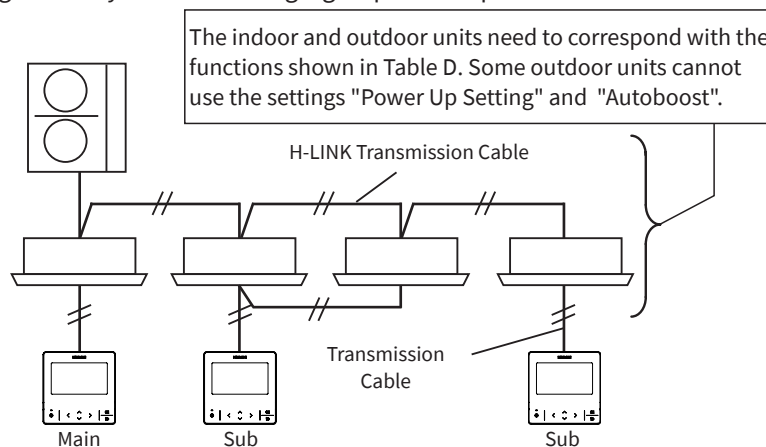

- Main Controller — Only One Controller in Same Refrigerant System
- Sub Controller — Controller in addition to the Main Controller in the same Refrigerant System

8. Main Remote Setting

- Concerning main and sub controllers, the range of settings may differ for the functions shown below.

Table D. Relation between Main/Sub Controller and Setting Range

| Function | | Main | Sub |
|--------------------------------|----------------------------|------|-----|
| Power Saving Details Setting | | ○ | × |
| Outdoor Unit Capacity Control | Details Setting | ○ | × |
| | Power Savings Level Switch | ○ | × |
| Indoor Unit Rotation Control | Details Setting | ○ | × |
| | ON/OFF | ○ | ○ |
| Intermittent Control | Details Setting | ○ | ○ |
| | Power Savings Level Switch | ○ | ○ |
| Night Quiet Operation | | ○ | × |
| Power Savings Schedule | Outdoor Capacity Control | ○ | × |
| | Intermittent Control | ○ | ○ |
| Night Quiet Operation Schedule | | ○ | × |
| Power Up Setting | | ○ | × |
| Autoboost | | ○ | ○ |

○: Available ×: Not Available

- Changing from the sub controller to the main controller.

Step1. Select "Installation Menu" on the Service & Installation screen by pressing "√" and press "OK".

Step2. Select "Main Remote Setting" by pressing "∧" or "√" and press "OK".

Step3. Select "Yes" and press "OK" to change to the main remote.

"Change to main remote" is displayed on the screen.

Select "Cancel" to return to Step2.

*After the change is completed, the Power Savings Mode will change to "No Setting". After the following functions initialized, reset the setting for the "Power Savings Setting", "Power Saving/Night Quiet Schedule", "Night Quiet Operation", "Priority Setting" and "Power Up Setting".

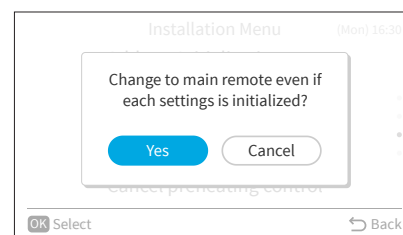

Step4. When the change to main remote control is completed, the "Reconfigure each setting" screen is displayed.

Step5. Press "OK" on the confirmation screen to return to Installation Menu.

NOTES:

- When using two controllers, only the primary controller can be set as the main controller. In cases where two controllers are both sub controllers, the "Main Remote Setting" is only accessible from the primary controller.
- In cases where the primary controller is a "Main Controller" and the secondary controller is a "Sub Controller", when the primary controller and the secondary controller are changed by the function selection, Main and Sub controllers will also be switched simultaneously.
- If the sub controller is displayed, the main remote controller may not function normally. Please verify the cable connection.
- If a remote control group is operating with multiple refrigerant systems, the ECO function may not operate normally.

9. Priority Setting

You can only set the operation mode and unit temperature setpoint from one specific controller (the main controller) in the same refrigerant system without having to use the central controller. The operation of sub controller is decided by the priority setting and power saving details setting of the main controller.

Example

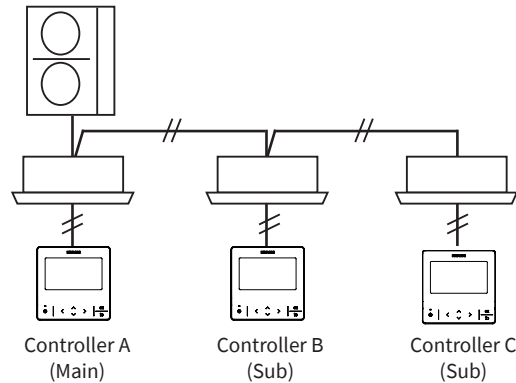

Table E. List of operations that can be performed when priority is set

| Priority Setting | | Remote Selection | | |
|------------------|---------------------------------------|--|--------------------------|----------------------|
| | | Controller A (Main) | Controller B and C (Sub) | |
| | | Operation Mode Temperature Setpoint | Operation Mode | Temperature Setpoint |
| Without Priority | | | ○ | ○ |
| With Priority | Operation Mode | ○ | ▲ | ○ |
| | Operation Mode + Temperature Setpoint | | ▲ | × |

○: Selection Possible

▲: Selection Possible Partially

- Operation Mode + FAN set by Controller A (Main)
- Only when COOL mode COOL↔DRY

×: Selection not possible (Apply to setting temperature of Controller A (Main))

NOTES:

- This controller comes normally pre-set with factory-supplied default settings. It is possible to set, depending on what is pre-set in the priority settings of the Test Run menu.
- Only the temperature setting cannot be set as priority. Also, even if operation mode is set as priority, in the case of COOL/HEAT Automatic Mode, the priority is temporarily overridden.
- It is not possible to set the "Cool/Heat Auto Changeover" and "Priority Setting" at the same time. In addition, the priority will be removed once the "Cool/Heat Auto Changeover" takes effect.
- When using two controllers, it is not possible to set priority.
- If one of the devices in the same refrigerant cycle is connected, the main function cannot be used.
 - Outdoor unit or Indoor unit power saving capabilities are not available
 - Receiver Kit
 - Central Controller
 - Advanced Wired Remote Controller and Wired Remote Controller are set "ON" with the selected operation mode, setting adjustment of Temperature Setpoint, and setting adjustment for cooling
 - Cooling/Heating Changeover Switch Unit

1. Set Operation Mode and Temperature Priority

Step1. Select "Installation Menu" on the Service & Installation screen and press "OK".

Step2. Select "Priority Setting" and press "OK".

Step3. Press "^" or "v" to change in order the "No Setting" ↔ "Operation Mode" ↔ "Operation Mode + Set Temp".

Select the setting and press "OK" to display the confirmation screen.

Step4. Press "↵" to return to the Installation Menu.

10. FrostWash

FrostWash is available when applicable outdoor units and indoor units are connected. To use this function in VRF system, outdoor unit function selection item "F1" need to be configured on outdoor units.

Please refer to the dedicated Service Manual for the FrostWash function.

Please configure function selection F1 on the outdoor units, and then set the wired remote controller.*1

Please also refer to the Operation Manual and Service Manual of Wired Remote Controller for details.

Please contact the distributor or service personnel for availability and configuration of this function.

1. About FrostWash

- Regarding the noise upon freezing and defrosting
Cracking noise may be heard during the freezing or defrosting phase due to temperature change. Refrigerant flow noise may also be heard. The noise may be heard relatively louder in a quiet environment. It is recommended to set the "Auto-FrostWash Schedule" when the room is not occupied.
Choose not to use the FrostWash function in places such as hotel rooms and hospitals, where consistent quietness is expected.
- Ice fog may come out from air outlet during the FrostWash operation.
Ice fog could happen in a humid environment such as the room humidifier is used in a small room.
- FrostWash is available when the outside temperature is in the range of 34°F - 110°F (1°C - 43°C), and the indoor temperature is in the range of 59°F - 86°F (15°C - 30°C).
Also refer to technical documents of outdoor units because outdoor temperature range may vary depending on outdoor units' type.
- The temperature around the indoor unit may drop slightly during FrostWash operation.

2. Start FrostWash

Generate frost on the coil and then melt the frost to wash the coil.

FrostWash setting is not enabled on the factory default setting.*1 Refer to "**FrostWash**" in the Operation Manual to enable this function.

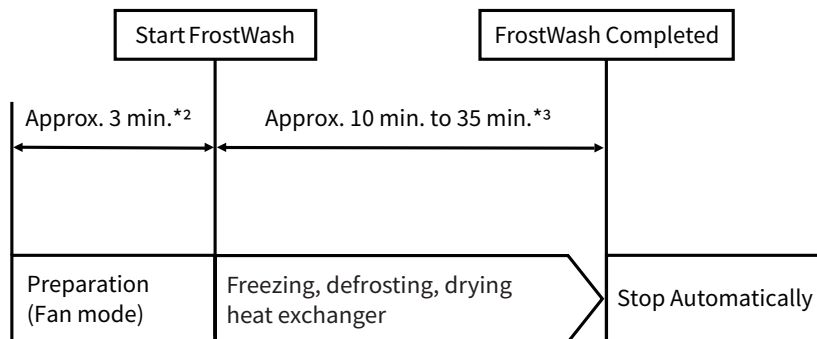

- Press "OK" on the wired remote controller to cancel FrostWash in the middle of an operation.
- After a cancellation, frost on the heat exchanger needs to be defrosted and the heat exchanger needs to be dried. The system cannot start operation for at least 8 minutes after cancellation.
- You cannot start another FrostWash immediately after a FrostWash operation completes. Run either cooling operation, heating operation or dry operation for approx. 60 minutes. Then, start another FrostWash operation.

NOTE:

- Do not open or remove the air inlet grill during the FrostWash operation. It may cause injury or damage of units.

3. FrostWash setting on outdoor unit

To use this function in the VRF system, function selection F1 needs to be configured on the outdoor units. FrostWash setting is disabled on the factory default setting.*1
Set Function Selection F1 according to the following table.

| "F1" Setting Condition | Auto-FrostWash | | Manual FrostWash |
|------------------------|---|--|---|
| | "Interval" Time Duration | Start-up Timing | Operation |
| 0 | Factory Setting (Default): Not available FrostWash | | |
| 1 | Total Comp. Operation Hour: 500h | 2 hours after system stopped | Operate outdoor unit PSW |
| 2 | Total Comp. Operation Hour: 1000h | | |
| 3 | Total Comp. Operation Hour: 500h | Within the time zone scheduled by Main wired remote controller*4,5 | |
| 4 | Total Comp. Operation Hour: 1000h | | |
| 5 | Total Indoor Unit Fan Operation Hour: Depending on Main Wired Remote Controller Setting | Within the time zone scheduled by Main wired remote controller*4,5 | Operate from Main wired remote controller*4 or operate outdoor unit PSW |

*1: When the air conditioner system supports FrostWash function and the function selection F1 of outdoor unit is set as valid, then the FrostWash is automatically valid.

*2: Change according to the outdoor unit.

*3: Change according to indoor temperature and outdoor temperature.

*4: Only one "Main wired remote controller" exists in the same refrigerant cycle, and all the others are "Sub wired remote controller". Refer to "8. Main Remote Setting" in this manual for the details of Main Wired Remote Controller setting.

*5: You can set the schedule for the FrostWash operation from the Main Remote Controller. Otherwise, the FrostWash operation will start soon after the system is stopped.

NOTE:

- Refer to the dedicated Service Manual for the FrostWash function.

11. Setback Trigger Unit

The setback trigger unit can be set from the Installation Menu.

Step1. Select the indoor unit by pressing "^", "v", "<", or ">" and press "OK" to display the confirmation screen.

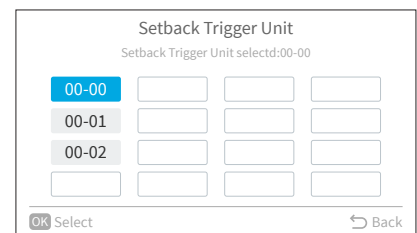

Step2. Select "Yes" and press "OK" to confirm the setting. Then, please wait a moment until the screen shows "Completed" or "Setting Disabled".
If "Cancel" is selected, the screen returns to the Setback Trigger Unit screen.

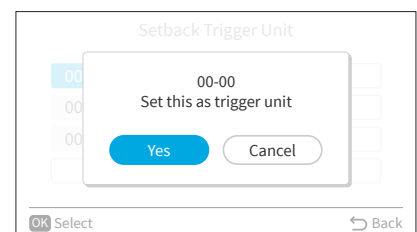

12. Operation Lock/Unlock Setting

- This function disables the setting mode of the remote controller.
- In the operation lock, when the lock icon "🔒" lights up, the mode cannot be changed by pressing "▲" or "▼".
- The following four types of setting modes can be locked.
 - Temperature Setting (Temp)
 - Operation Mode (Mode)
 - Fan Speed
 - Louver Swing (Louver)

1. Set Operation Lock/Unlock

Step1. In "Service & Installation", select "Service Menu" and press "OK".

Step2. Select "Lock Function".

Step3. Press "▲" or "▼" and press "OK".

The operation changes as follows:

"Temp. Setting" ↔ "Op. Mode" ↔ "Fan Speed" ↔ "Louver Swing".

Step4. Press "▲" or "▼" to select "Unlock" and press "OK" to confirm the setting.

Step5. Press "↶" to return to Step3.

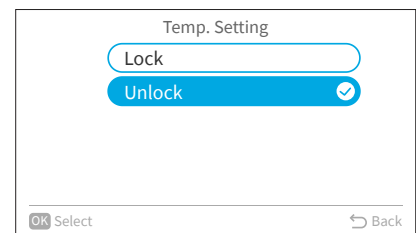
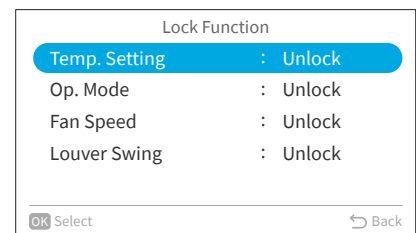
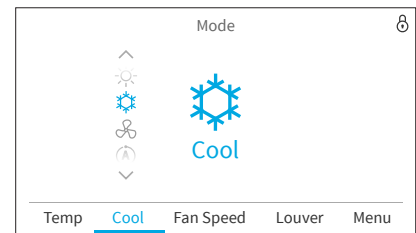

NOTES:

- If the function selection (item F8-Fb) is set to "01", 🔒 is displayed and the setting item cannot be set.
- Don't use the operation lock function when remote control is set to "prohibit" on the central controller.
- If both the "prohibit lock" and "prohibit remote control" operations are set at the same time, the "prohibit remote control" operation has priority.
- If the setting is changed from "prohibit remote control operations" to "permit all remote control operations", all operation locks are released.

13. Password Setting

The default user password can be changed. If you forget the changed user password, a supervisor password can be used to reset the user password again. The supervisor password is "5567".

The password input effective time can be set also.

If the password input effective time has been set, then the password is required to be entered only once during the password effective time.

1. Change Password

- Step1. Select "Service Menu" on the Service & Installation screen and press "OK".
- Step2. Select "Password Setting" and press "OK".
- Step3. Select "Change Password" and press "OK".
- Step4. Use "^", "v", "<", or ">" to enter the password you want to set, select "OK" and press "OK".

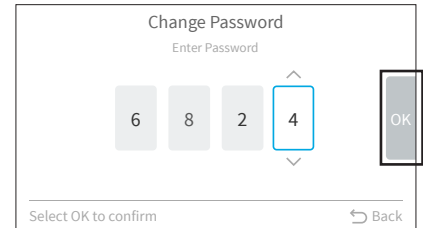

- Step5. Press "^" or "v" to select "Save" and press "OK" to change password.
Select "Not Save", the screen returns to Step3.
Press ">", the screen returns to Step2.

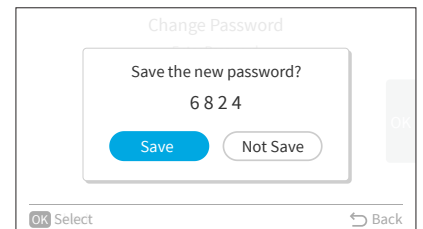

- Step6. Press "OK", the screen returns to Step2.

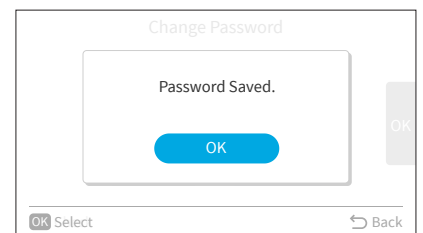

2. Set Password Input Effective Time

- Step1. Select "Service Menu" on the Service & Installation screen and press "OK".
- Step2. Select "Password Setting" and press "OK".
- Step3. Select "Effective Time" and press "OK".
- Step4. Press "^" or "v" to select the setting item and press "OK" to confirm the setting. The item changes as follows:
"Everytime" ↔ "10 min" ↔ "30 min" ↔ "60 min" ↔ "120 min".
Press ">" and it returns to Step3.

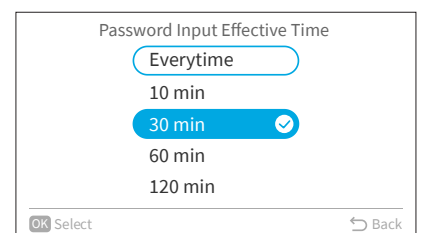

NOTES:

- In order to enhance the security protection, please be sure to change the default password.
- If you enter the wrong password more than 5 times, you will not be able to enter the password within 1 minute.
- The default password is "0000", and the supervisor code is "5567".
- If you forget the password, use the supervisor code to change the password.
- The supervisor code can't be changed.
- For two remote controllers, the passwords are not synchronized automatically. For each remote controller, the password needs to be set individually.

14. Hotel Mode Setting

This setting enables or disables the hotel mode.

- Step1. Select "Service Menu" on the Service & Installation screen and press "OK".
- Step2. Select "Hotel Mode" and press "OK".
- Step3. Press "^" or "v" to select enabled setting.
- Step4. After selecting, press "OK".
- Step5. Select "Yes" and press "OK" to confirm the settings and display the completion screen.
- Step6. If you select "Cancel", the screen returns to Step3.

NOTE:

- Refer to "**Hotel Mode Setting**" in Operation Manual.

15. Power Saving Details Setting

This function provides the details for setting the power savings function.

For the "Mode", select one item from each of the following settings, (1) outdoor unit capacity control, (2) indoor unit rotation control, and (3) intermittent control.

NOTES:

- The power savings mode that can be switched differs depending on the type of the outdoor unit or indoor unit.
- Go to Power Savings Setting from Function Menu. Also refer to "**Power Savings Setting**" in the Operation Manual for details.

| Item | Function |
|----------------------|---|
| Capacity Control | Reduce the heating and cooling capacity of the indoor unit. Set control mode and power savings level with its corresponding value. |
| Rotation Control | Interlock with indoor units of the same outdoor unit system and switch to FAN operation in sequence. Set control mode and fan mode time. |
| Intermittent Control | Cooling/heating mode and fan mode are repeated at regular intervals. Set power savings level. |
| Reset Default | Initialize the power saving details settings. |

(1) Outdoor Capacity Control Setting

| Item | Description |
|------------------------------|---|
| Control Method | The "Peak Cut Control" reduces the power consumption range when it exceeds the value of the power setting. On the basis of the current air conditioning capacity, the "Moderate Control" is used to moderate the air conditioning capacity as well as the peak. |
| Power Savings Low (Med/High) | Assign the corresponding capacity control values to the low, medium, and high power savings levels. |
| Change Level | The power saving details setting can change the power savings levels. |

1. Outdoor Unit Capacity Control Setting

- Step1. Select "Service Menu" on the Service & Installation screen and press "OK".
- Step2. Select "Power Saving Details Setting" and press "OK".
- Step3. Select "Capacity Control" and press "OK".

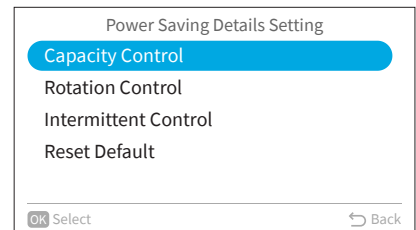

- Step4. Press "^" or "v".
The items "Control" ↔ "Sav: Low" ↔ "Sav: Med" ↔ "Sav: High" are displayed in order.
Press "↵" to move to Step7.

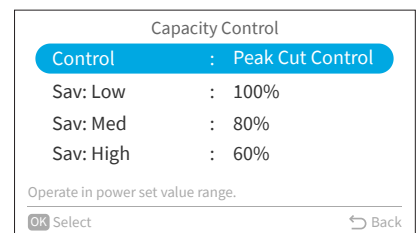

- Step5. Change the Control Method
Select "Control" and press "OK".
Press "^" or "v" to select the item to set and press "OK".
It changes between "Peak Cut Control" and "Moderate Control".
Press "↵" to return to Step4.

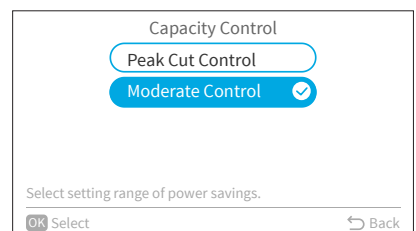

- Step6. Change the power savings level
Select "Sav: Low/Med/High" and press "OK".
Press "^" or "v" to set the level.
→ The level changes as follows:
[100%] ↔ [90%] ↔ [80%] ↔ [70%] ↔ [60%] ↔ [50%] ↔ [40%] ↔ [0%].
After setting, select "OK" and press "OK" and it returns to Step3.

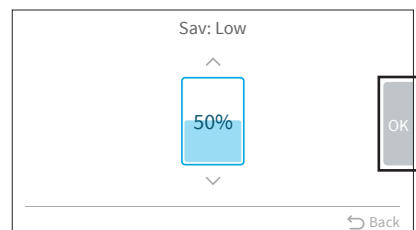

15. Power Saving Details Setting

- Step7. Change level
 Press "^" or "v" to select the item to set and press "OK".
 It changes in the order of "Low <-> Med <-> High" ↔ "Low only" ↔ "Med only" ↔ "High only".
 Press "↵" to return to Step 3.

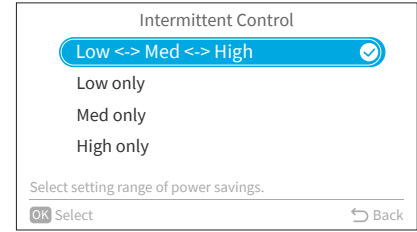

NOTES:

- For the sub remote controller, only the level switching order can be set.
- If the "Power Savings Mode" changes the "Power Saving Details Setting" in outdoor capacity control, the "Power Savings ON/OFF" deactivates.
- The outdoor capacity can be clarified as "Low Power Savings" > "Med Power Savings" > "High Power Savings".
- The cooling/heating capacity can decrease when using the "Power Savings" function.

(2) Indoor Unit Rotation Control Setting

| Item | | Description |
|----------------|-------------------|---|
| Control Method | Address Order | The number (address) assigned by the previous indoor unit changes the FAN mode of the indoor unit in ascending order. |
| | Temperature Order | The difference between the temperature setpoint and the indoor unit intake temperature changes the FAN mode in ascending order for the indoor unit. |
| | Sensor Order | If the motion sensor is used, this function changes the FAN mode in order, from the indoor unit in a spacious area with few people. |
| Change Level | | It is possible to change the timing of the FAN operation of the indoor unit. |

1. Set Indoor Unit Rotation Control

Step1. Select "Service Menu" on the Service & Installation screen and press "OK".

Step2. Select "Power Saving Details Setting" and press "OK".
 → Power Saving Details Setting screen is displayed.

Step3. Select "Rotation Control" and press "OK".

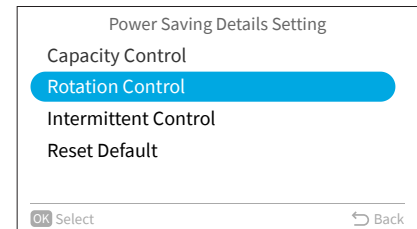

Step4. Press "^" or "v" to select the setting item.
 The items "Control" and "Fan Mode Time" are displayed in order.

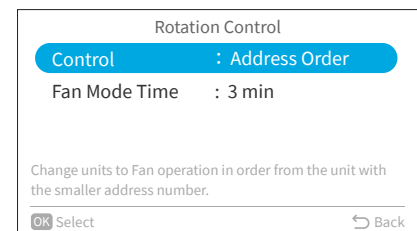

Step5. Change the Control Method
 Select "Control" and press "OK".
 Press "^" or "v" to select the item to set and press "OK".
 It changes as follows:
 "Address Order" ↔ "Temperature Order" ↔ "Sensor Order".
 Press "↵" to return to Step4.
 ※Cannot be set if the indoor/outdoor unit does not support this function.

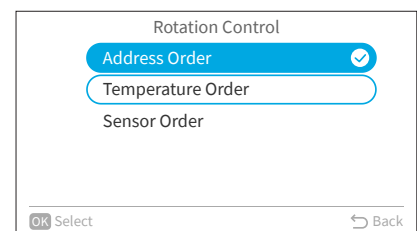

- Step6. Change the Fan Mode Time
 Select "Fan Mode Time" and press "OK".
 Press "▲" or "▼" to set the fan mode time. Press "OK" to confirm the setting.
 It changes as follows:
 "10 min" ↔ "5 min" ↔ "3 min".
 Press "↵" to return to Step4.

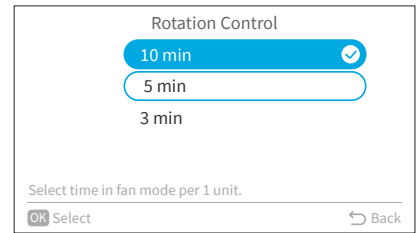

NOTES:

- Indoor rotation control cannot be set for the sub remote controller.
- If the "Power Savings Mode" changes the "Power Saving Details Setting" in outdoor capacity control, the "Power Saving ON/OFF" deactivates.
- This function can be used only when the operation mode is cooling/heating.
- The cooling/heating capacity can decrease when using the "Power Saving" function.

(3) Intermittent Control Setting

| Item | Description |
|--------------|---|
| Level Change | The power saving details settings can change the power savings level. |

1. Set Intermittent Control

- Step1. Select "Service Menu" on the Service & Installation screen and press "OK".
 Step2. Select "Power Saving Details Setting" and press "OK".
 → Power Saving Details Setting screen is displayed.
 Step3. Select "Intermittent Control" and press "OK".

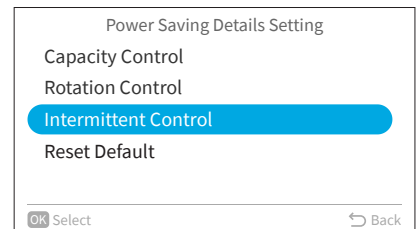

- Step4. Change level
 Press "▲" or "▼" to select the level and press "OK".
 It changes as follows:
 "Low ↔ Med ↔ High" ↔ "Low only" ↔ "Med only" ↔ "High only".
 Press "↵" to return to Step3.

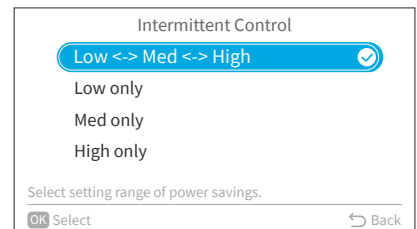

NOTES:

- This function cannot be set when only the total heat exchanger is connected.
- Each power savings level repeats the operation as follows:

| | Cool/Dry Mode | Heat Mode |
|---------------------|--|--|
| Power Saving : LOW | Normal Mode 20 minutes ↔ Fan Mode 10 minutes | Normal Mode 25 minutes ↔ Fan Mode 5 minutes |
| Power Saving : MED | Normal Mode 17 minutes ↔ Fan Mode 13 minutes | Normal Mode 20 minutes ↔ Fan Mode 10 minutes |
| Power Saving : HIGH | Normal Mode 15 minutes ↔ Fan Mode 15 minutes | Normal Mode 15 minutes ↔ Fan Mode 15 minutes |

- If the "Power Savings Mode" changes the "Power Saving Details Setting" in intermittent control, the "Power Saving ON/OFF" turns OFF.
- The cooling/heating capacity can decrease when using the "Power Saving" function.

(4) Reset Method

1. Reset power saving details setting to default values

- Step1. Select "Service Menu" on the Service & Installation screen and press "OK".
 Step2. Select "Power Saving Details Setting" and press "OK".
 Step3. Select "Reset Default" and press "OK".
 Step4. Select "Yes" and press "OK", reset the power saving details to default and return to Step2.
 Select "Cancel" and press "OK", return to Step2.

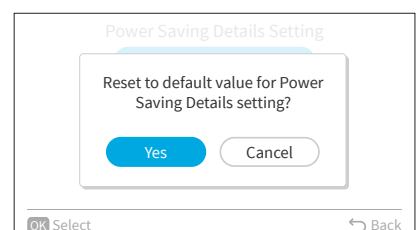

16. Temperature Range Restriction

The temperature range can be set by the wired remote controller.

1. Set Temperature Range
 - Step1. Select "Service Menu" on the Service & Installation screen and press "OK".
 - Step2. Select "Temperature Range Restriction" and press "OK".
 - Step3. Select "Upper/Lower Limit for Cooling", "Upper/Lower Limit for Heating" or "Upper/Lower Limit for Auto mode" and press "OK".
 - Step4. Press "^", "v", "<", or ">" to select the setting value.
 - Step5. After value setting, select "OK" and press "OK". Press "↵" to return to Step3.

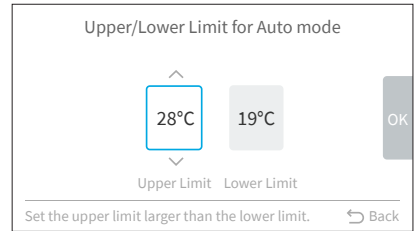
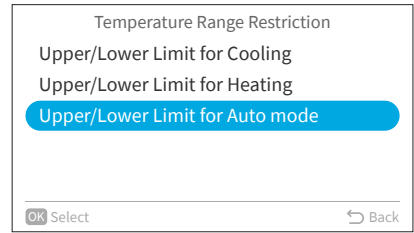

- When Dual Setpoint is enabled, the Upper/Lower limit of the temperature range restriction can be set for Cooling and Heating separately. Please note that the settings should follow the rule "cooling upper/lower limit ≥ heating upper/lower limit + 2°C (3°F)".

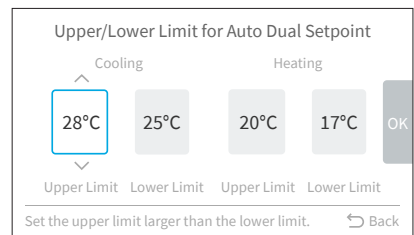

NOTES:

- Please ensure that the upper heating limit is set equal to or greater than the lower limit value.
- Different indoor and outdoor units may have different temperature ranges.
- The temperature range restriction settings for Auto mode (including Auto Dual Setpoint) are only available when Auto mode is enabled on this product. Some indoor units may not support Auto mode.
- When using two wired remote controllers connected to the same indoor unit, both the upper and lower limit settings for Auto mode (including Auto Dual Setpoint) are not synchronized on the two controllers. It is necessary to set the same value on each of the two controllers respectively.

17. Dual Setpoint Setting

The setting allows you set the temperature of cooling and heating individually.

To use this function, refer to the Item b8 (Page 10) to enable auto function in function selection.

1. Set Dual Setpoint
 - Step1. Select "Service Menu" on the Service & Installation screen and press "OK".
 - Step2. Select "Dual Setpoint" and press "OK".
 - Step3. Press "^" or "v" to select "ON" or "OFF".
 - Step4. Press "OK" to confirm the setting.
 - Step5. Press "↵" to return to Step2.

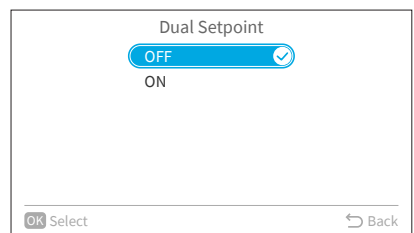

18. Main/Sub Display Setting

The main or sub display of the remote controller can be turned off.

1. Set the main/sub display invisible.
 - Step1. Select "Service Menu" on the Service & Installation screen and press "OK".
 - Step2. Select "Main/Sub Display" and press "OK".
 - Step3. Press "^", "v", "<", or ">" to select "Not Display".
 - Step4. Press "OK" to confirm the setting.
 - Step5. Press "↶" to return to Step2.

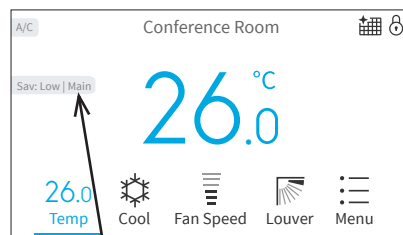

| With Priority Setting | No Priority Setting |
|-----------------------|---------------------|
| Main | No icon |
| Sub | |

19. Room Name Setting

Register the installation location of the controller.

1. Register Room Name
 - Step1. Select "Service Menu" on the Service & Installation screen and press "OK".
 - Step2. Select "Set Room Name" and press "OK".
 - Step3. Press "<" to move cursor to font type. Press "^" or "v" to select the font type.
*Each time you want to change the font type, press "<" to move the cursor back to font type.
 - Step4. Press ">" to move the cursor to the keypad. Press "^", "v", "<", or ">" to select the font and press "OK" to register it. (Up to 32 characters can be used for each room name.)
 - Step5. After all the characters have been set, select "Fin" and press "OK".
 - Step6. The confirmation screen is displayed. Select "Yes" and press "OK" to confirm the settings and Step2 is displayed. If "No" is selected, the screen returns to Step3.

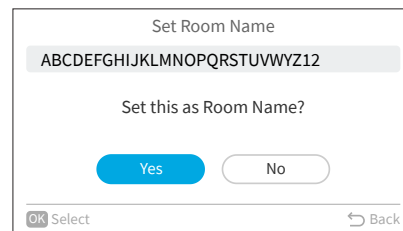
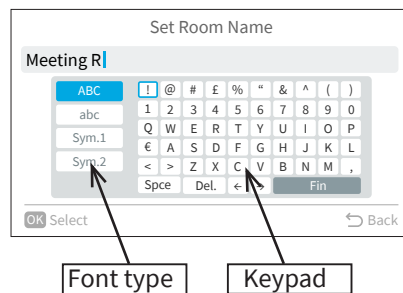

20. Contact Information Registration

Register a service contact (service address and service telephone number are recommended).

1. Register Contact Information

Step1. Select "Service Menu" on the Service & Installation screen and press "OK".

Step2. Select "Set Contact Information" and press "OK".

Step3. "Contact Information1" screen is displayed. Press "<" to move cursor to font type. Press "^" or "v" to select the font type.

*Each time you want to change the font type, press "<" to move the cursor back to font type.

Step4. Press ">" to move cursor to the keypad. Press "^", "v", "<", or ">" to select the font and press "OK" to register it. (Up to 60 characters can be used for each contact information.)

Step5. After all the characters have been set, select "Fin" and press "OK".

Step6. "Contact Information2" screen is displayed, repeat Step3, Step4 and Step5.

Step7. Select "Yes" and press "OK" to confirm the setting and Step2 is displayed.

If "No" is selected, the screen returns to Step3.

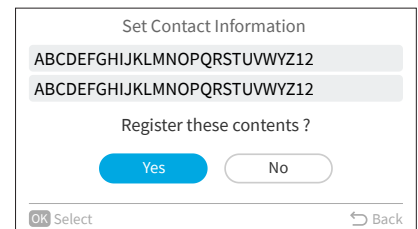
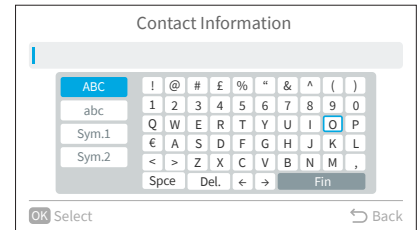

21. NFC Function

Use the smart phone with NFC function to read and write all the setting data of the wired remote controller. When using NFC, you should make this setting enabled. The default setting is "Enable".

NOTES:

- NFC is the abbreviation of "Near field communication".
- NFC function is supported on the smartphone listed below.
 iPhone^{*1} Model: iPhone7 or newer, OS: please refer to the operation manual of airCloud Tap.
 Andriod^{*2} Model: Smartphone with NFC function^{*3}, OS: please refer to the operation manual of airCloud Tap.
 *1: Apple and iPhone are trademarks of Apple Inc. registered in the U.S. and other countries and regions. iOS is a trademark or registered trademark of Cisco in the United States and other countries and is used under license.
 *2: Andriod is a trademark registered by Google LLC.
 *3: Some Android smartphone models cannot be supported. Please refer to the App operation manual for details.
- NFC can improve service and installation. If the wired remote controller may be accessible to unauthorized third-party, please set the NFC to "Disable".
- Please refer to the App operation manual for how to use the application.

1. Download App

To download the "airCloud Tap" application, search for it on the "App Store"^{*1} or "Google Play"^{*2}.

Alternatively, you can scan the code provided below with your smartphone to directly access the application.



*1: App Store[®] is a service mark of Apple Inc.

*2: Google Play and the Google Play logo are trademarks of Google LLC.

NOTE:

- An internet connection is required to download, update, or use airCloud Tap (user registration, etc.). Customers are responsible for internet communication costs.

2. Set NFC

- Step1. Select "Service Menu" on the Service & Installation screen and press "OK".
- Step2. Select "NFC setting" and press "OK".
- Step3. Press "^" or "v" to select "Enable".
- Step4. Press "OK" to confirm the setting.
- Step5. Press "↩" to return to Step 2.

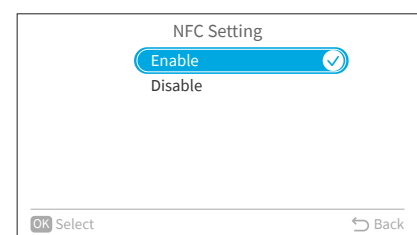

3. Read and Write Settings

NFC communication can only be performed when the specific screen for it is displayed on the remote control. Please make sure to display the "NFC communication screen" before attempting to read or write settings. Please bring the NFC receiver of the smartphone closer to the NFC receiver of the remote control.

NOTES:

- When using an iPhone, NFC is located on the top of the smartphone.
- The location of the NFC depends on the smartphone. Please check the operation manual of your smartphone.
- For NFC operation on smartphone, please refer to the operation manual of airCloud Tap.

21. NFC Function

(1) "NFC communication screen" for operations of reading & writing settings, canceling preheating control, operate test run, obtain error history and product information.

Step1. Display the home screen on the wired remote controller and hold the "<" and ">" buttons simultaneously for 3 seconds.

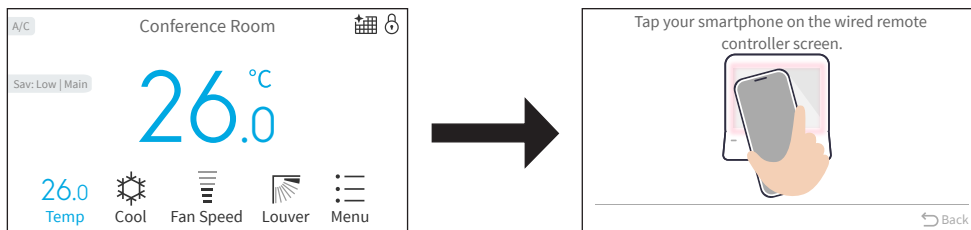

Step2. The NFC antenna is built into the wired remote controller LCD screen. Tap the NFC part of the smartphone near the LCD screen.



(2) "NFC communication screen" for collecting Check 1, Check 2, and Check PCB of the Units

Step1. For Check 1 and 2, tap the smartphone over the LCD screen while the values are displayed. The NFC icon appears in the upper right corner of the screen.

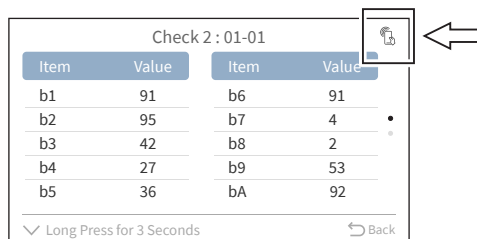

Step2. For Check PCB of the Units, tap the smartphone over the LCD screen while the diagnosis result is displayed. The NFC icon appears in the upper right corner of the screen.

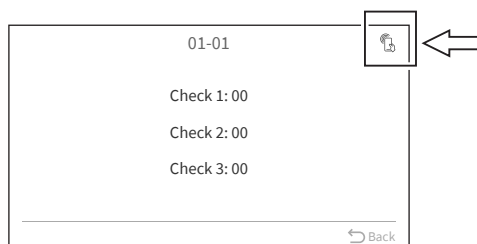

22. Backup System Setting

This function is to setup the backup operation for multiple refrigerant system. The operation and standby of units can be set at selected rotation cycle time.

NOTES:

- This function is not available for one or more than five refrigerant systems.
- This function cannot be set when connecting with econo-fresh, total heat exchanger or fresh air ventilator.
- This function is available only when connecting outdoor units and indoor units support it.
- This function is not available when the operation mode is "Cool/Heat Auto Changeover". Also, during operation of the backup system, "Cool/Heat Auto Changeover" is not displayed in the operation mode.
- When using two wired remote controller, this function can only be set on the primary wired remote controller.
- The rotation sequence is the order of the refrigerant system number.
- If "Rotation Cycle Time" or "No. of Refrig. Systems to operate" is changed, the rotation sequence is initialized.
- For the icon of backup system, please refer to the "**3.7 Icon Description**" in the operation manual.

Backup System Functions

1. Rotation Operation

Operation and standby(※1) are done at rotation cycle time set by the wired remote controller for each refrigerant system.

System Example

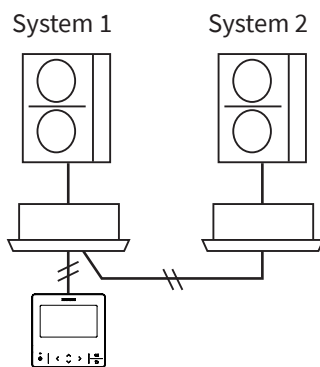

Rotation procedure

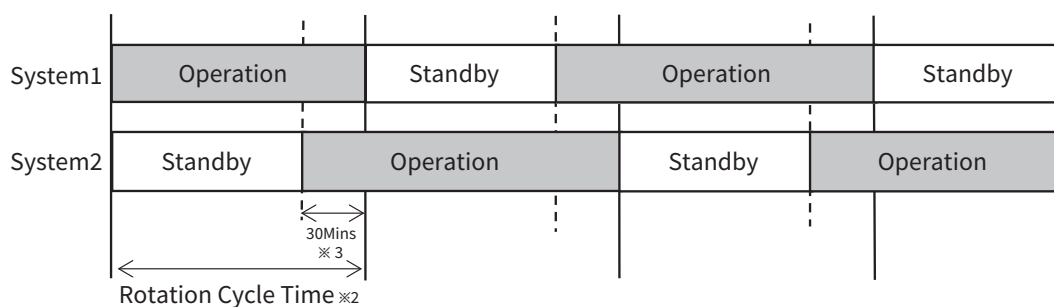

※1: In fan mode(Thermo-off).

※2: Choose from "9 hours"(default), "24 hours", "48 hours", "72 hours" and "96 hours".

※3: In order to stabilize the operation state, it shall be started before 30 minutes.

22. Backup System Setting

2. Backup operation when abnormality occurs

If an abnormality occurs during the rotation operation, the standby refrigerant systems return back to operation.

System Example

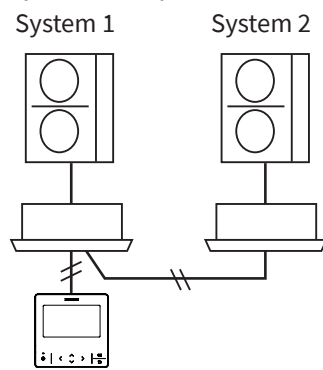

Rotation procedure when abnormality occurs

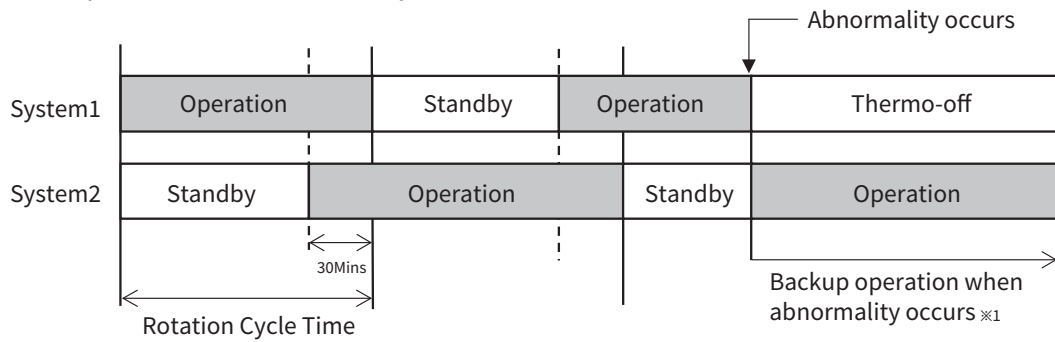

- ※1: When the abnormality is resolved, it returns to the rotation operation.
- Backup operation runs for 30 minutes when abnormality occurs.
- All standby systems are in backup operation when abnormality occurs.

3. Backup operation in high load

If there is a difference between the room temperature and the setting temperature (※1), the standby refrigerant systems start to operate.

System Example

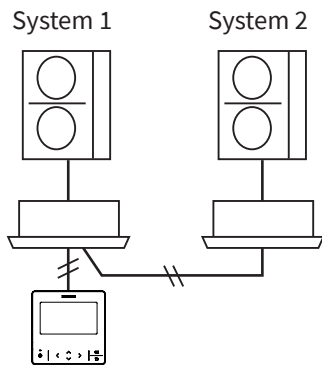

Procedure of high load backup operation

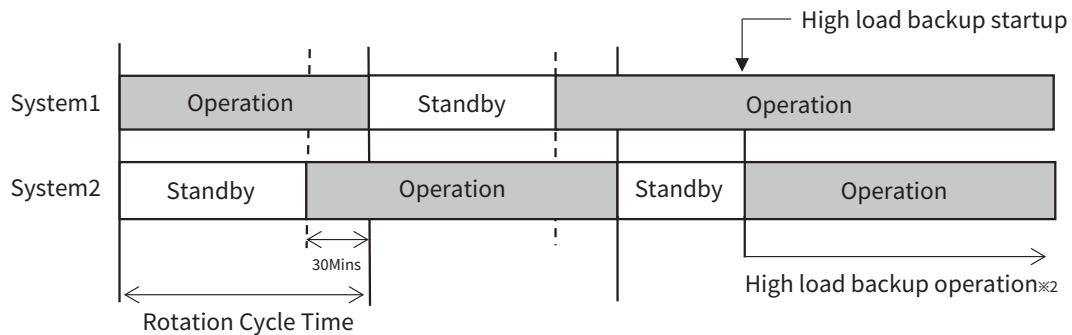

※1: Cooling/Heating: 2°C to 5°C(2°F to 5°F).

※2: When the high load backup operation is finished, it turns into the rotation operation.
All standby systems are in operation.

22.1 Backup System Setting Items

1. Enable/Disable Backup System

This function is to enable/disable rotation operation.

Enable: Start rotation operation.

Disable: Rotation operation is invalid.(Default)

2. Rotation Cycle Time

Rotation cycle time can be set from "9 hours"(default), "24 hours", "48 hours", "72 hours" and "96 hours".

3. No. of Refrig. Systems to Operate

System Example

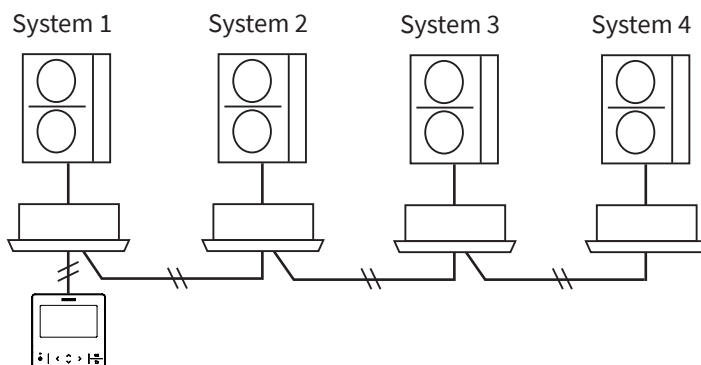

22. Backup System Setting

Choose 1 System(default)

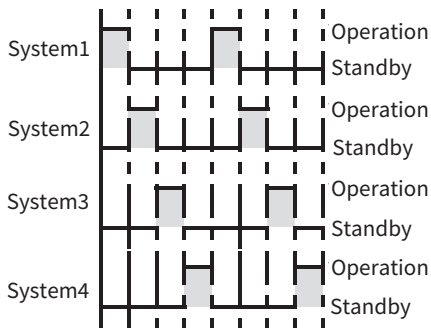

Choose 2 Systems

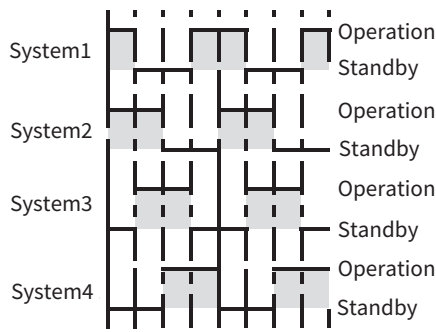

Choose 3 Systems

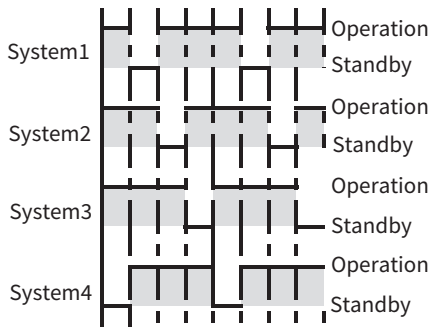

NOTES:

- Number of refrigerant systems to operate are not more than total connected systems.
- Operation before 30 minutes is omitted.

4. High Load Startup

This function is to backup operation in high load.

When the setting temperature of cooling and heating are all "OFF", the high load startup is unavailable.

22.2 Set Backup System

1. Set Backup System

- Step1. Select "Service Menu" on the Service & Installation screen and press "OK".
- Step2. Select "Backup System Setting" and press "OK".
- Step3. Press "^" or "v" to select the setting item. It changes as follows:
"Enable/Disable Backup System" ↔ "Rotation Cycle Time" ↔
"No. of Refrig. Systems to Operate" ↔ "High Load Startup".
- Step4. Press "OK" to confirm the selection.

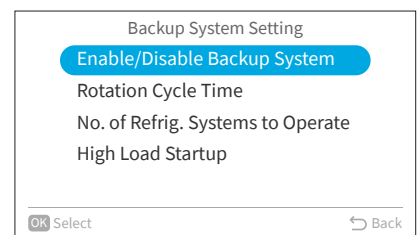

2. Enable/Disable Backup System

- Step1. Select "Enable/Disable Backup System" on the backup system setting screen and press "OK".
- Step2. Press "v" to select "Enable".
- Step3. Press "OK" to confirm the setting.
- Step4. Press "↶" to return to Step1.

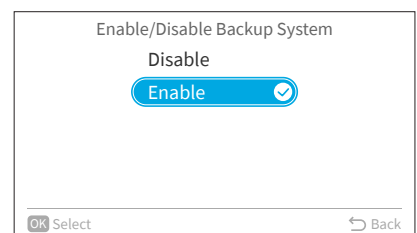

3. Rotation Cycle Time

- Step1. Select "Rotation Cycle Time" on the backup system setting screen and press "OK".
- Step2. Press "^" or "v" to select the cycle time.
- Step3. Press "OK" to confirm the setting.
- Step4. Press "↵" to return to Step 1.

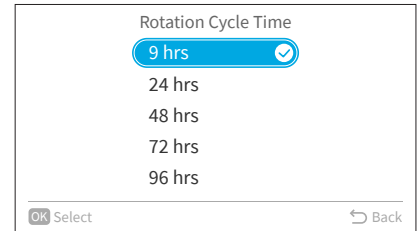

4. No. of Refrig. Systems to Operate

- Step1. Select "No. of Refrig. Systems to Operate" on the backup system setting screen and press "OK".
- Step2. Press "^" or "v" to select the system numbers.
- Step3. Press "OK" to confirm the setting.
- Step4. Press "↵" to return to Step1.

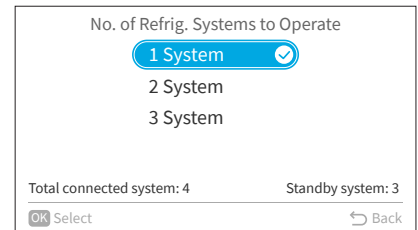

5. High Load Startup

- Step1. Select "High Load Startup" on the backup system setting screen and press "OK".
- Step2. Press "<" or ">" to choose Cool/Heat. Press "^" or "v" to select the setting temperature.
- Step3. Press ">" to select "OK", press "OK" to return to Step1.

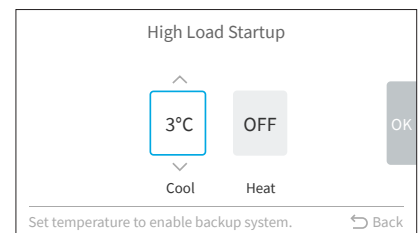

NOTE:

- High load startup is available only when outdoor and indoor units support it.

23. Adjusting Date/Time

Set the date and time. The setting is recommended in that it will be used to check the alarm history and set the schedule.

1. Adjusting Date/Time

- Step1. While the air conditioner is stopped, press ">" to select "Menu" and press "OK".
While the air conditioner is operating, press ">" to select "Menu" and display the Menu screen.
- Step2. Select "Screen Display Setting" and press "OK".
- Step3. Select "Adjusting Date/Time" and press "OK".
- Step4. Select "Adjusting Date/Time" and press "OK".
- Step5. Press "<" or ">" to select "yyyy/mm/dd/hh/mm".
Press "^" or "v" to change the settings.
Press and hold "^" or "v" to increase or decrease continuously.
→ The day of the week changes.
- Step6. After making all settings,
If select "OK" and press "OK", the screen returns to Step4.
If press "↵", the confirmation screen displays.
Select "Save" and press "OK" to save the setting. The screen returns to Step4.
Select "Not Save", the screen returns to Step4 without any setting changes.
If press "↵" again, the screen returns to Step5.

NOTE:

- Please also refer to "Adjusting Date/Time" in the Operation Manual.

24. Check Menu

This menu displays various statuses of the air conditioner.

1. Enter Check Menu

- Step1. Select "Check Menu" on the Service & Installation screen and press "OK".

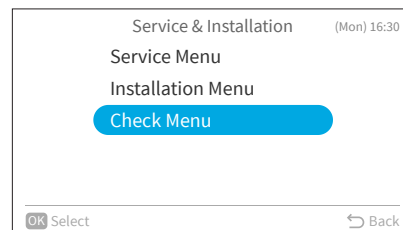

Each "Check Menu" item and its function is explained in the following table.

| Item | Function |
|-------------------------|---|
| Check 1 | Sensor condition of the heat pump are monitored and displayed. |
| Check 2 | Sensor data from the heat pump prior to alarm occurrence is displayed. |
| Alarm History Display * | Previous alarm history data including date, time, indoor unit number, and alarm code is displayed. (30 Max) The alarm history can be deleted.* |
| Display Model Number | Model name and manufacturing number are indicated. |
| Check PCB of the Units | The result and diagnosis of PCB check is displayed. |
| Self Check | The controller checkout process begins and various settings initialize. |

* Press "OK" while the alarm history is displayed, the confirmation screen for deleting the alarm history is displayed.

Select "Yes" and press "OK" to delete the alarm history.

25. ESP Setting

This function is used for adjusting External Static Pressure (ESP). It is available only for selected airCore 700 ducted indoor units that support this feature.

NOTES:

- This function is exclusively available when the system is connected to airCore 700 ducted indoor units that support Auto ESP setting. Please confirm the indoor unit compatibility with your service agent.
- If you are using two wired remote controllers, you can configure this function solely through the primary wired remote controller.

1. ESP Setting

Step1. Select "Service Menu" on the Service & Installation screen and press "OK".

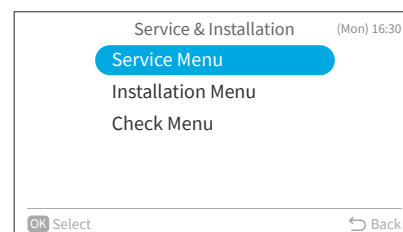

Step2. Select "ESP Setting" and press "OK".

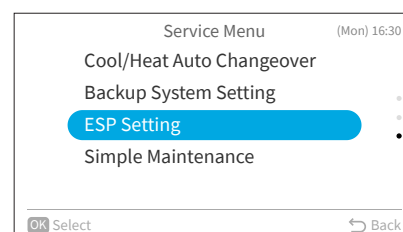

Step3. Press "^" or "v" to select the setting item.

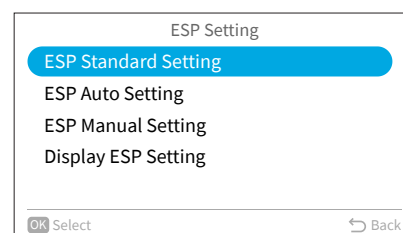

Step4. Press "OK" to confirm the selection.

2. ESP Standard Setting

Step1. Select "ESP Standard Setting" on the ESP Setting screen and press "OK".

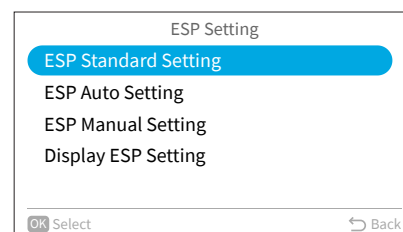

Step2. Select the indoor unit by pressing "^", "v", "<", or ">" and press "OK".
(This screen is NOT displayed when only one indoor unit is connected with the controller. In this case, "Step3" is displayed.)

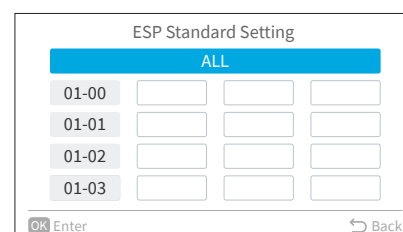

25. ESP Setting

Step3. Press "^" or "v" to select the setting and press "OK" to confirm the setting.

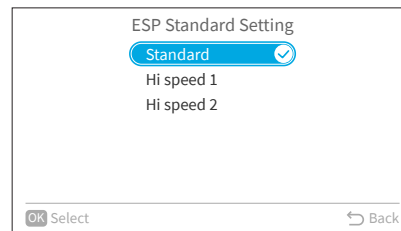

Step4. Press "↵" to return to Step2 screen. Pressing "^", "v", "<", or ">" and press "OK" to set another indoor unit, or press "↵" again to return to ESP Setting screen.

NOTES:

- ESP Standard setting is the same as C5 of function selection.
- When changing C5 of function selection, the change is valid immediately if ESP setting is standard mode. Otherwise, the change will not be valid until ESP setting is changed to standard mode.

3. ESP Auto Setting

Step1. Select "ESP Auto Setting" on the ESP Setting screen and press "OK".

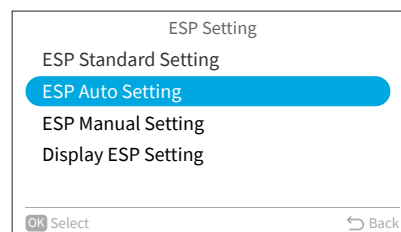

Step2. Select the indoor unit by pressing "^", "v", "<", or ">" and press "OK".
(This screen is NOT displayed when only one indoor unit is connected with the controller. In this case, Step3 is displayed.)

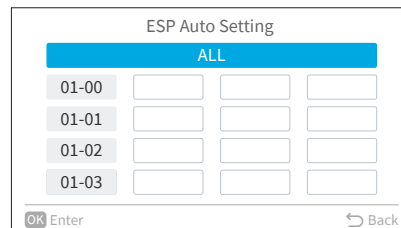

Step3. Select "Yes" and press "OK" to start auto ESP.

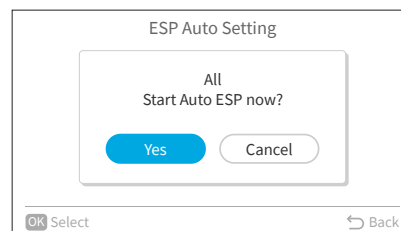

Step4. In Checking ESP screen,

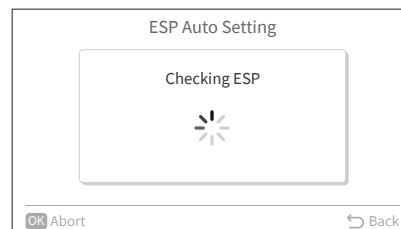

- a. wait for the "Completed" screen shows, select "Continue" and return to Step 2 to select another indoor unit for auto ESP. Or select "Complete" to return to Step1.

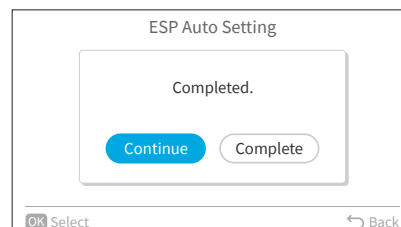

- b. Press "OK" in Checking ESP screen.
 - b-1 Select "Yes" and press "OK" to stop auto ESP, select "Continue" and return to Step2 to select another indoor unit for auto ESP. Or select "Complete" to return to Step1.

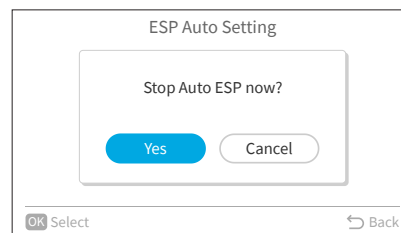

- b-2 Select "Cancel" to continue auto ESP.

Step5. Press "↶" again to return to ESP Setting screen.

NOTES:

- If two wired remote controllers are connected, when the primary wired remote controller starts auto ESP, the secondary wired remote controller will turn to auto ESP screen from home screen automatically, and turns back to home screen only if:
 - a. the auto ESP is stopped or completed.
 - b. 120mins passed
- In auto ESP process, pressing On/Off button is not valid.

4. ESP Manual Setting

Step1. Select "ESP Manual Setting" on the ESP Setting screen and press "OK".

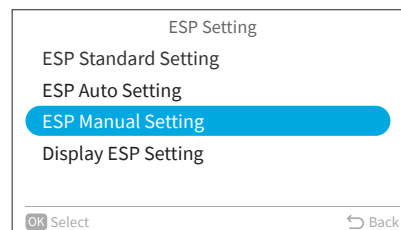

Step2. Select the indoor unit by pressing "^", "v", "<", or ">" and press "OK".
(This screen is NOT displayed when only one indoor unit is connected with the controller. In this case, Step3 is displayed.)

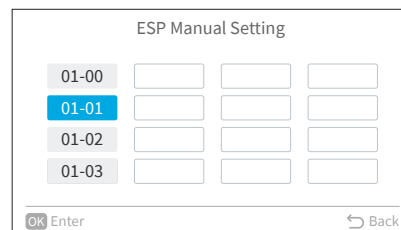

Step3. Press "^" or "v" to change the ESP value.
a. Press ">" to select "OK" and press "OK" to save the setting and return to Step2.

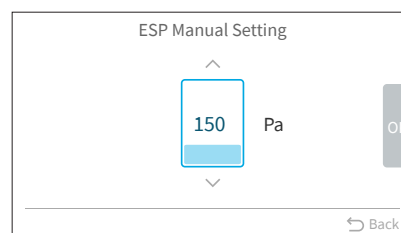

b. Press "↶", the "Change ESP setting to this value" shows, select "Yes" and press "OK" to confirm the value change.

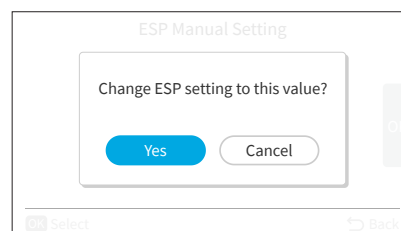

25. ESP Setting

5. Display ESP Setting

Step1. Select "Display ESP Setting" on the ESP Setting screen and press "OK".

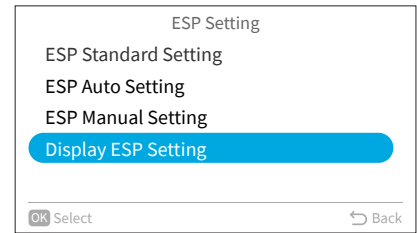

Step2. Select the indoor unit by pressing "^", "v", "<", or ">" and press "OK".
(This screen is NOT displayed when only one indoor unit is connected with the controller. In this case, Step3 is displayed.)

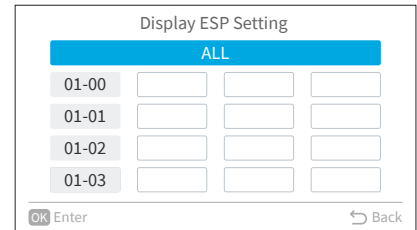

Step3. The present setting of mode and ESP value are displayed.

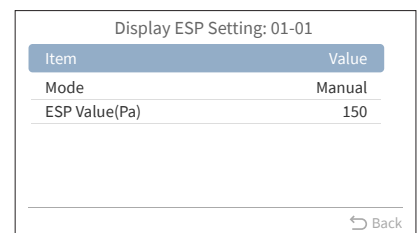

26. Premium Zoning Function

26.1 Zone Installation Menu

If the wired controller is connected to the zone interface box, "Zone Installation Menu" is displayed in "Service & Installation Menu". For the way of activating zoning kit function, please see Installation and Maintenance Manual of Zone Interface Box.

Step1. Select "Zone Installation Menu" and press "OK".

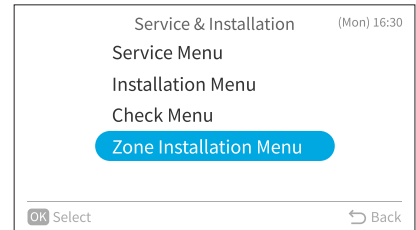

NOTES:

- When "common zone setup" is not set, "⊗" are displayed for other setting items and they cannot be set.
- When "common zone setup" has been set, but "zone activation" has not been set, "⊗" are displayed for other setting items after "Zone Labeling".

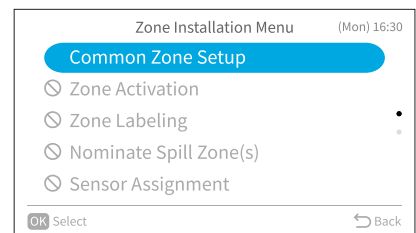

26.1.1 Common Zone Setup

A common zone is one that does not have a damper and damper motor installed. Whenever the air conditioning system is operated, this zone is always ON. Refer to Installation and Maintenance Manual of Zone Interface Box for detailed information.

Step1. Select "Common Zone Setup" and press "OK".

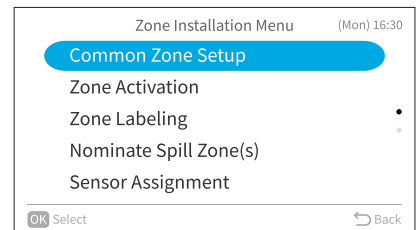

Step2. Press "OK".

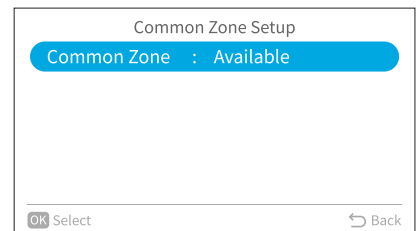

Step3. Press "∧" or "∨" to select the setting and press "OK".

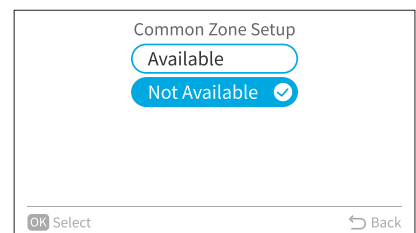

Step4. Press "↵" to return to Zone Installation Menu.

26. Premium Zoning Function

26.1.2 Zone Activation

This function is to enable or disable zone from zone1 to zone8.

Step1. Select "Zone Activation" and press "OK".

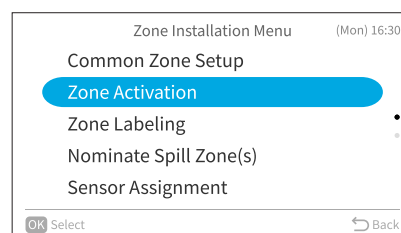

Step2. Press "^" or "v" to select zone, press "<" to set to "Activate", press ">" to set to "None".

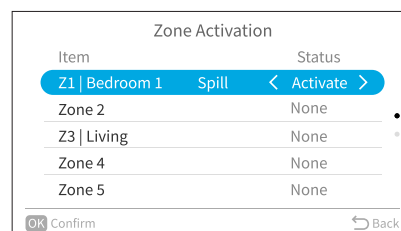

Step3. Press "OK" to save the setting and return to Zone Installation Menu. Or press "↶" to return to Zone Installation Menu without saving the setting.

NOTE:

- The spill zone cannot be set to "None", the spill zone need to be cancelled first.

26.1.3 Zone Labeling

This function is to personalize the naming of zones and sensors.

Step1. Select "Zone Labeling" and press "OK".

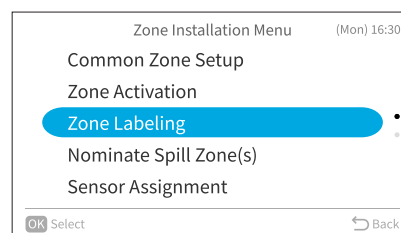

Step2. Press "^" or "v" to select zone and press "OK".

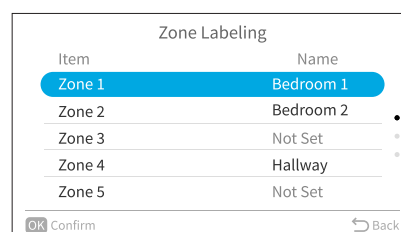

Step3. Press "<" to move cursor to font type.
 Press "^" or "v" to select the font type.
 *Each time you want to change the font type, press "<" to move the cursor back to font type.
 ** ♥ " has a list of 12 typical zone names pre-entered, the name will appear in the input box directly once the one is selected.

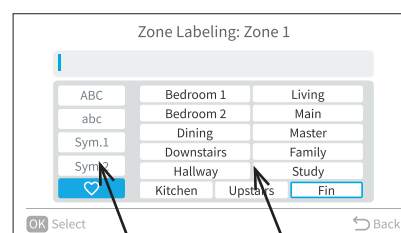

Font type

Keypad

Step4. Press ">" to move the cursor to the keypad.
 Press "^", "v", "<", or ">" to select the font and press "OK". (Up to 12 characters can be used for zone labelling.)

Step5. After all the characters have been set, select "Fin" and press "OK".

Step6. The confirmation screen is displayed.
Select "Yes" and press "OK" to confirm the settings and Step2 is displayed.

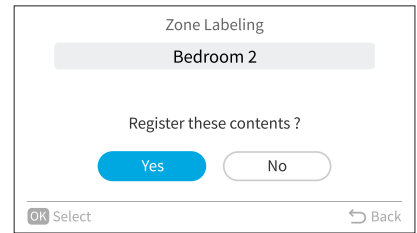

26.1.4 Nominate Spill Zone(s)

Step1. Select "Nominate Spill Zone(s)" and press "OK".

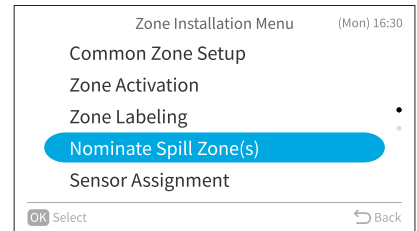

Step2. Press "∧" or "∨" to select spill zone.
Press "<" or ">" to select zone.

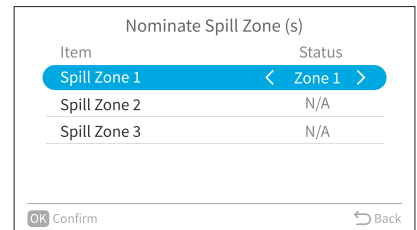

Step3. Press "OK" to save the setting and return to Zone Installation Menu. Or press "↵" to return to Zone Installation Menu without saving the setting.

NOTES:

- If common zone is not available, at least one spill zone should be nominated.
- Spill Zone1-3 should be set to different zones.

26. Premium Zoning Function

26.1.5 Sensor Assignment

This function is to assign the specified sensor to the activated zone.

Step1. Select "Sensor Assignment" and press "OK".

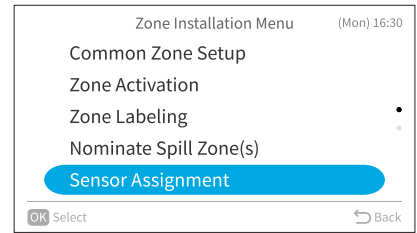

Step2. Press "^" or "v" to select sensor.
Press "<" or ">" to assign sensor to the target zone.

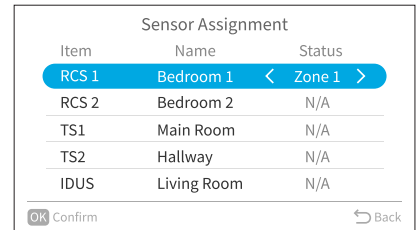

Step3. Press "OK" to save the setting and return to Zone Installation Menu. Or press "↵" to return to Zone Installation Menu without saving the setting.

NOTES:

- Sensor name and description

| Sensor Name | Description |
|-------------|---|
| RCS1 | Temperature Sensor of primary WRC |
| RCS2 | Temperature Sensor of secondary WRC (optional) |
| TS1 | Remote Sensor 1 connected to ZIB (THM2, optional) |
| TS2 | Remote Sensor 2 connected to ZIB (THM3, optional) |
| IDUS | Inlet Air Temperature Thermistor of IDU |

- If only one wired remote controller is connected or Wi-Fi adapter is connected, sensor "RCS2" will not be displayed.
- Multiple sensors can be assigned to one zone.

26.1.6 Airflow

This function is to set the airflow value for each activated zone and common zone(if available).

Step1. Select "Airflow" and press "OK".

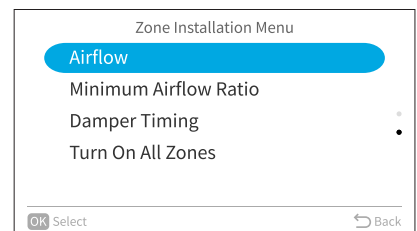

Step2. Press "^" or "v" to select zone and press "OK" to Step3.
Or press "↵" to return Zone Installation Menu.

The screenshot shows the 'Airflow' screen with a table of zones and their airflow values. The 'Z1 | Bedroom1' zone has a 'Spill' status and an airflow of 378 L/s. Other zones listed include Z2 | Bedroom2, Z3 | LDK, Zone 4, and Zone 5.

| Zone | Airflow (L/s) |
|---------------|---------------|
| Z1 Bedroom1 | Spill 378 |
| Z2 Bedroom2 | 275 |
| Z3 LDK | 123 |
| Zone 4 | 58 |
| Zone 5 | 78 |

- Step3. Press "<" or ">" to select the item.
Press "^" or "v" to set value(unit: L/s).

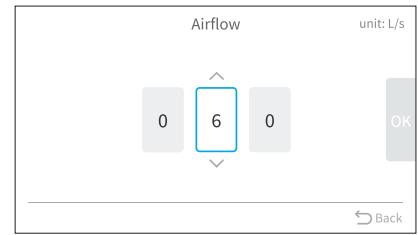

- Step4. Select "OK" and press "OK" to save the setting and return to Step2. Or press "↵" to return to Step2 without saving the setting.

26.1.7 Minimum Airflow Ratio

- Step1. Select "Minimum Airflow Ratio" and press "OK".

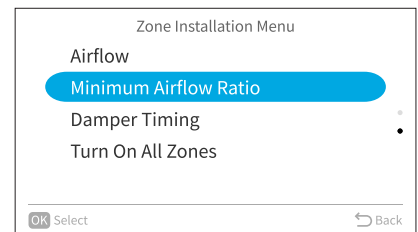

- Step2. Press "<" or ">" to select the item.
Press "^" or "v" to set value.

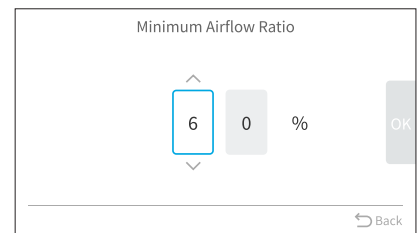

- Step3. Select "OK" and press "OK" to save the setting and return to Zone Installation Menu.
Or press "↵" to return to Zone Installation Menu without saving the setting.

NOTE:

- The value range of Minimum Airflow Ratio is 01~99(%).

26.1.8 Damper Timing

- Step1. Select "Damper Timing" and press "OK".

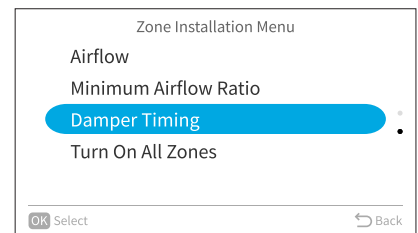

- Step2. Press "<" or ">" to select the item.
Press "^" or "v" to set value(unit: Sec.).

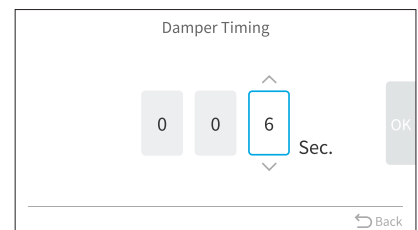

- Step3. Select "OK" and press "OK" to save the setting and return to Zone Installation Menu.
Or press "↵" to return to Zone Installation Menu without saving the setting.

NOTE:

- The value range of Damper Timing is 006~150(Sec.).

26. Premium Zoning Function

26.1.9 Turn on All Zones

This function is to turn on all the activated zones at the same time.

Step1. Select "Turn on All Zones" and press "OK".

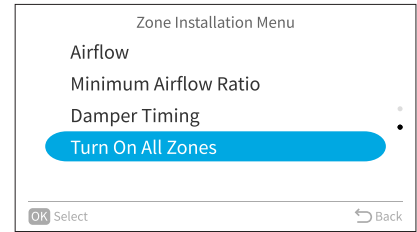

Step1. Press "<" or ">" to select to select "Yes" or "No", and press "OK" to return to Zone Installation Menu.

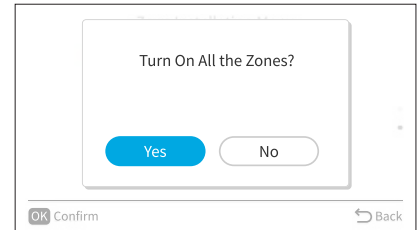

26.2 Check for Zoning Kit

This function is to display various statuses of the air conditioner.

Step1. Select "Check Menu" on "Service & Installation Menu" and press "OK".

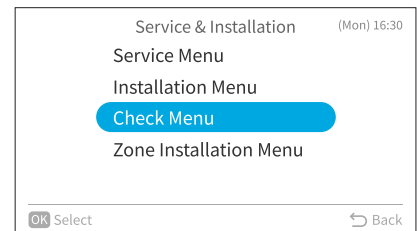

Step2. Select check item in table below and press "OK".

Step3. Select "Zoning Kit" and press "OK".

| Item | Function |
|-------------------------------------|---|
| Check 1 (zoning kit) | Sensor condition of zoning kit are monitored and displayed. |
| Alarm History Display (zoning kit) | Previous alarm history data of zoning kit is displayed (Max 30). The alarm history can be deleted. |
| Check PCB of the Units (zoning kit) | The result and diagnosis of ZIB's PCB check is displayed. |

26.3 Features Not Available When Connected with Zoning Kit

When connected with zoning kit, the following features described previously on this manual will be disabled.

| No. | Function |
|-----|------------------------------|
| 1 | Dual Setpoint |
| 2 | Hotel Mode |
| 3 | Test Run (Fan Speed Setting) |
| 4 | Room Name Display |
| 5 | Priority Setting |
| 6 | NFC Function |

