

INSTALLATION MANUAL

airHome 600

SPLIT UNIT AIR CONDITIONER

INDOOR UNIT
RAK-VJ50PHAT
RAK-VJ60PHAT
RAK-VJ70PHAT



EN INSTRUCTION MANUAL

FOR SERVICE PERSONNEL ONLY

- Carefully read through the procedures of proper installation before starting installation work.
- The sales agent should inform customers regarding the correct operation of installation.

Tools Needed For Installation Work

- (Mark ⊕ is exclusive use tool for R32)
- ⊕ Screwdriver
 - Measuring Tape
 - Knife
 - Saw
 - φ 65mm Power Drill
 - Hexagonal Wrench Key (1/4 4mm)
 - Wrench (14,17,19,22mm)
 - Gas Leakage Detector
 - Pipe Cutter
 - Putty
 - Vinyl Tape
 - Pliers
 - Flare Tool
 - Vacuum Pump Adaptor
 - Manifold Valve
 - Charge Hose
 - Vacuum Pump

- WARNING**
- Please request your sales agent or qualified technician to install your unit. Water leakage, short circuit or fire may occur if you do the installation work yourself.
 - Please observe the instructions stated in the installation manual during the process of installation. Improper installation may cause water leakage, electric shock and fire.
 - Make sure that the units are mounted at locations which are able to provide full support to the weight of the units. If not, the units may collapse and impose danger.
 - Observe the rules and regulations of the electrical installation and the methods described in the installation manual when dealing with the electrical work. Use cables which are officially approved in your country. Be sure to use the specified circuit. A short circuit and fire may occur due to the use of low quality wire or improper work.
 - Be sure to use the specified cables for connecting the indoor and outdoor units. Please ensure that the connections are tight after the conductors of the wire are inserted into the terminals to prevent the external force is being applied to the connection section of the terminal base. Improper insertion and loose contact may cause over-heating and fire.
 - Please use the specified components for installation work. Otherwise, the units may collapse or water leakage, electric shock, fire or stronger vibration may occur.
 - Be sure to use the specified piping set for R32. Otherwise, this may result in broken copper pipes or faults.
 - When installing or transferring an air conditioner to another location, make sure that air other than the specified refrigerant(R32) does not enter the refrigeration cycle. If other air should enter, the pressure level of the refrigeration cycle may increase abnormally which could result in a rupture and injury.
 - Be sure to ventilate fully if a refrigerant gas leak while at work. If the refrigerant gas comes into contact with fire, a poisonous gas may occur.
 - After completion of installation work, check to make sure that there is no refrigeration gas leakage. If the refrigerant gas leaks into the room, coming into contact with fire in the fan-driven heater, space heater, etc., a poisonous gas may occur.
 - Unauthorized modifications to the air conditioner may be dangerous. If a breakdown occurs please call a qualified air conditioner technician or electrician. Improper repairs may result in water leakage, electric shock and fire, etc.
 - Be sure to connect the earth line from the power supply wire to the outdoor unit and between the outdoor and indoor unit. Do not connect the earth line to the gas tube, water pipe, lighting rod or the earth line of the telephone unit. Improper earthing may cause electric shocks.
 - When finishing the refrigerant collection (pumping down), stop the compressor and then remove the coolant pipe. If you remove the refrigerant pipe while the compressor is operating and the service valve is released, air is sucked and a pressure in the freezing cycle system will build up steeply, causing an explosion or injury.
 - When installing the unit, be sure to install the refrigerant pipe before starting the compressor. If the refrigerant pipe is not installed and the compressor is operated with the service valve released, air is sucked and the pressure level of the refrigeration cycle may increase abnormally which could result in a rupture and injury.
 - The electric cables should neither be reworked nor added. Make sure to use an exclusive circuit breaker. Otherwise fire or electric shock might occur by connection failure, isolation failure or over current.
 - Make sure to connect cables to terminal properly and terminal cover should close firmly. Otherwise, over heating at terminal contact, fire or electric shock might occur.
 - Make sure that there is no dust on any connected points of electric cables and fix firmly. Otherwise, fire or electric shock might occur.

SAFETY PRECAUTION

- Read the safety precautions carefully before operating the unit.
- The contents of this section are vital to ensure safety. Please pay special attention to the following sign.

- WARNING** Incorrect methods of installation may cause death or serious injury.
- CAUTION** Improper installation may result in serious consequence.
- !** Make sure to connect earth wire.
- ⊘** This sign in the figures indicates prohibition.

Be sure that the unit operates in proper condition after installation. Explain to customer the proper operation and maintenance of the unit as described in the user's guide. Ask a customer to keep this installation manual together with the instruction manual.



Access the full version of the User Installation Manual by scanning the code.

Cooling & Heating

<IA2311: A>

The Choice of Mounting Site (Please note the following matters and obtain permission from customer before installation).

- CAUTION**
- A circuit breaker must be installed in the house distribution box for the direct connected power supply cables to the outdoor unit. In case of other installations a main switch with a contact gap or more than 3mm has to be installed. Without a circuit breaker, the danger of electric shock exists..
 - Do not install the unit near a location where there is flammable gas. The outdoor unit may catch fire if flammable gas leaks around it.
 - Please ensure smooth flow of water when installing the drain hose. Improper installing may wet your furniture.
 - An IEC approved power cord should be used. Power cord type: NYM.

	WARNING This symbol shows that this equipment uses a flammable refrigerant. If the refrigerant is leaked, together with an external ignition source, there is a possibility of ignition.
	CAUTION This symbol shows that the Operation Instructions should be read carefully.
	CAUTION This symbol shows that a service personnel should be handling this equipment with reference to the Installation Manual.
	CAUTION This symbol shows that there is information included in the Operation Manual and/or Installation Manual.

- WARNING**
- The unit should be mounted at stable, non-vibratory location which can provide full support to the unit.

- CAUTION**
- No nearby heat source and no obstruction near the air outlet is allowed.
 - The clearance distances from top, right and left are specified in figure below.
 - The location must be convenient for water drainage and pipe connection with the Outdoor unit.
 - No nearby leakage risk of flammable gas, and no nearby source of vapor or oil smoke.
 - To avoid interference from noise, please place the unit and its remote controller at least 1m from the radio and television.
 - To avoid any error in signal transmission from the remote controller, please put the controller far away from high-frequency machines and high-power wireless systems.
 - The installation height should be at least 2300 mm or more from the floor.
 - The distance from the air outlet to the fire alarm must be at least 1500mm and there must be no fire alarm in the front direction of the indoor unit.

Figure showing the Installation of Indoor Unit.

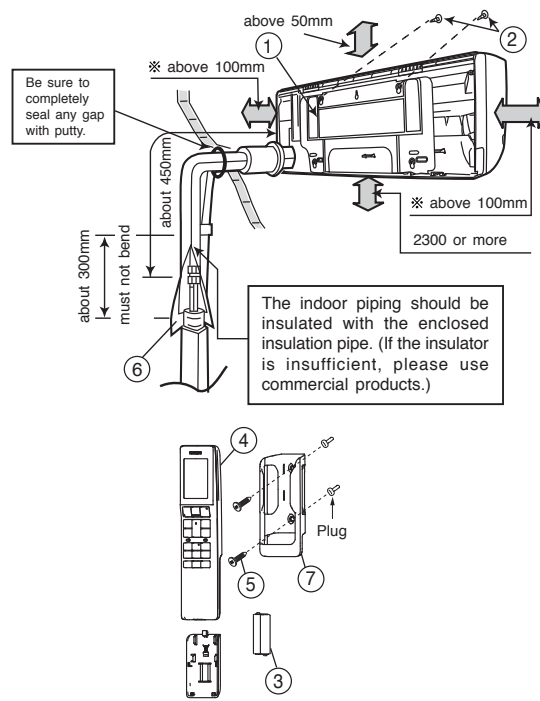

Names of Indoor Components

No.	Item	Qty
①	Hanger	1
②	Screw for Hanger	6
③	AAA size Battery	2
④	Remote Controller	1
⑤	Screw for Remote Controller Holder	2
⑥	Air purifying filter	2
⑦	Remote Controller Holder	1

Direction of Piping

Backward piping from left

Connection

There are 6 directions allowed, namely, backward piping, backward piping from left, horizontally piping from right, horizontally piping from left, vertically down from right, vertically down from left.

1 Installation of Hanger, Wall Penetration and Installation of Protection Pipe

- CAUTION**
- The draining of the water container inside the indoor unit can be done from the left. Therefore the hanger must be fixed horizontally or slightly tilted towards the side of drain hose. Otherwise, condensed water may overflow the water container.

Direct Mounting On The Wall

- Please use hidden beams in the wall to hold the hanger.

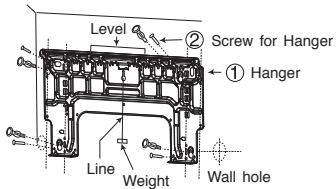
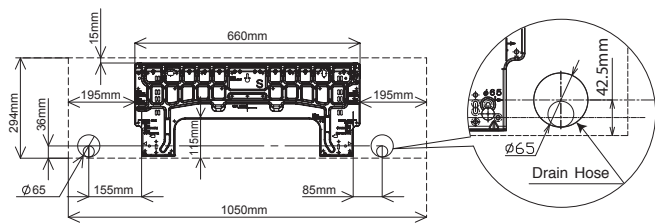

Screw the hanger at the positions possibly near the upper and lower hooks where the indoor unit is hung. Use 4 or more screws to fix the hanger.

Procedures of Installation and Precautions

- Procedures to fix the hanger.
- 1. Drill holes on wall. (As shown below)
- 2. Push plug into the holes. (As shown below)
- 3. Fix the hanger on wall with 4.1 x 32 screw (As shown in figure below)

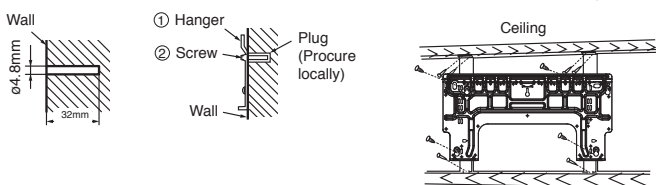

Wall Penetration and Installation of Protection Pipe

- Drill a φ 65mm hole on wall which is slightly tilted towards the outdoor side. Drill the wall at a small angle.
- Cut the protection pipe according to the wall thickness.
- Empty gap in the sleeve of protection pipe should be completely sealed with putty to avoid dripping of rain water into the room.
- Please ensure smooth flow of water when installing the drain hose. Improper installing may wet your furniture.
- An IEC approved power cord should be used. Power cord type: NYM.

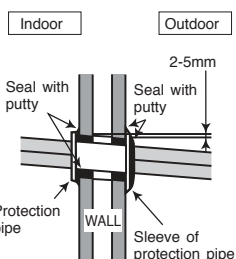

WARNING

Be sure that the wire is not in contact with any metal in the wall. Please use the protection pipe as wire passing through the hollow part of the wall so as to prevent the possibility of damaged by mouse. Unless it seals completely, any air with high humidity flows from outdoor and dew may drop.

2 Installation of the Indoor Unit

Cutting Low Cover bush

- While installing the pipe from the right, left or bottom side, use a knife to cut openings as shown in figure. Then smoothen the edges of openings with a file.

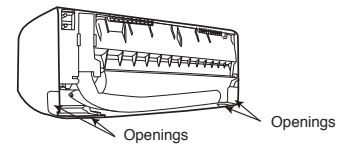

1 PIPING FROM THE RIGHT SIDE (BACKWARD, DOWNWARD, HORIZONTAL)

Preparation

- Connect connecting cord.
- Pull out the pipe, connecting cord and drain hose.

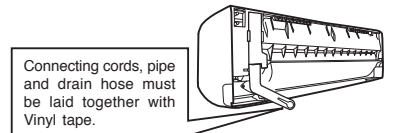

Installation

- Insert the pipe through the wall hole.
- ① The upper part of the Indoor unit is hung on the hanger.
- ② The projection at the lower part of the Indoor unit is hooked onto the hanger

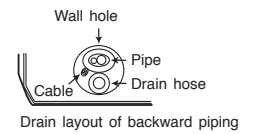
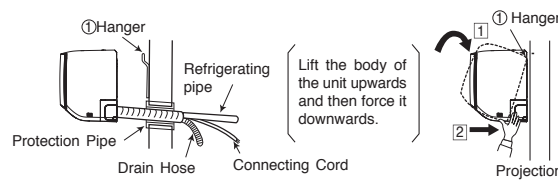

2 PIPING FROM THE LEFT SIDE (BACKWARD, DOWNWARD, HORIZONTAL)

Preparation

Changed of Drain Hose and Installation Procedures

- Exchange the location of drain hose and drain cap while installing the pipe from the left side as shown in below. Be sure to plug in the drain hose until the insulating material folds upon itself.

- Please use pliers to pull out the drain cap. (This is an easier way to remove the drain cap).

CAUTION
Insufficient insert may result in water leakage.

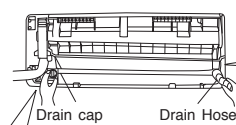

- Push the pipe deeply until the insulating section of the drain hose end gets over the rib at the indoor unit side.

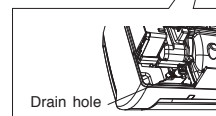

- Remove low cover.
- Insert drain cap up to the location securely till the cap stops.

CAUTION

- The rubber strap used for fixing the insulator should not be tied with great force. Otherwise, this will damage heat insulation and causes water condensation..
- Please pull the lower part of the indoor unit outwards to check if the unit is hooked onto the hanger. Improper installation may cause vibration and noise.
- Transform the piping while holding down the lower portion of pipe-support by hand.

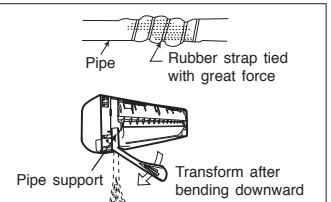

THE CONNECTION OF REFRIGERATING PIPE DURING THE INSTALLATION OF INDOOR UNIT

Preparation To Install Refrigerating Pipes

- The refrigerating pipes and connecting cord arrangement are attached.

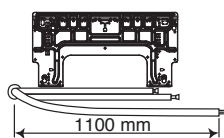

Please bend at a small radius to form an arc below 5mm

Installation

Hang the Indoor unit onto the hanger. Use the temporary stand at the back of the Indoor unit to push its lower part 15cm forwards.

- Place the drain hose through the hole on the wall.
- Wrap the refrigerating pipes with insulation pipe after connecting refrigerating pipe.
- Connect the connecting cord after removing low cover. (Refer to "Connection of Power Cord")
- After adjustment, the connecting cord and refrigerating pipes are placed into the space available under the Indoor unit.
- The projection of Indoor unit must hook to the mounting plate.

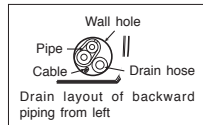
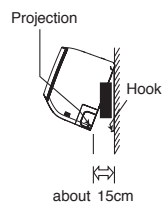

Pull this to the front during the connection of refrigerating pipes to ease task.

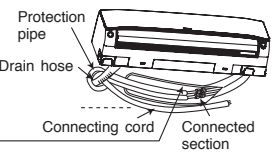

Bottom Cover Removal and Installation

When connecting the refrigerant pipe, the bottom cover can be removed for easy installation.

Bottom cover installation

- Put the 4 claws at front of the bottom cover into the indoor unit notch.
- Push the left and right claw of bottom cover into the unit.

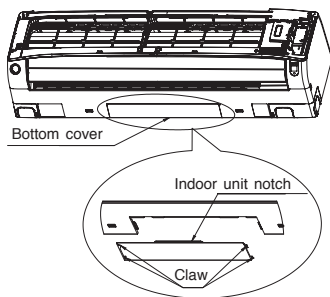

INSTALLATION AFTER CONNECTION OF REFRIGERATING PIPES

- The refrigerating pipe should be adjusted to fit into the hole on the wall and then ready for further connection.
- The terminals of 2 connected pipes must be covered with insulator used for terminal connection. Then the pipes are wrapped with insulating pipe.
- Connect the connecting cord after removing low cover. (Refer to "CONNECTION OF POWER CORD")
- After adjustment, fit the connecting cord and pipes into the space available under the unit. Use holder to hold them tight.
- Be sure to cut the extra binding band. (Otherwise, it may result in abnormal noise or dewfall.)

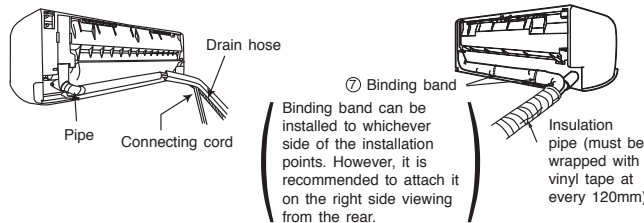

1 Preparation of Pipe

- Use a pipe cutter to cut the copper pipe.



CAUTION

- Remove burr and jagged edge will cause leakage.
- Point the side to be trimmed downwards during trimming to prevent copper chips from entering the pipe.
- Before flaring, please put on the flare nut.

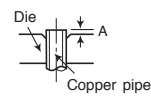
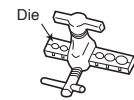

- Please use exclusive tool for refrigerant R32

Outer Diameter mm (inch)	Thickness (mm)	A (mm)		
		Flare tool for R32 Clutch type	Conventional flare tool	
			Clutch type	Wing nut type
6.35 (1/4")	0.8	0.0 ~ 0.5	1.0 ~ 1.5	1.5 ~ 2.0
9.52 (3/8")	0.8	0.0 ~ 0.5	1.0 ~ 1.5	1.5 ~ 2.0
12.70 (1/2")	0.8	0.0 ~ 0.5	1.0 ~ 1.5	1.5 ~ 2.5
15.88 (5/8")	1.0	0.0 ~ 0.5	1.0 ~ 1.5	1.5 ~ 2.5

2 Pipe Connection

CAUTION

- In case of removing flare nut of an indoor unit, first remove a nut of small diameter side, or a seal cap of big diameter side will fly out. Free from water into the piping when working.
- Be sure to tighten the flare nut to the specified torque with a torque wrench. If the flare nut is overtightened, the nut may be split after a long period has passed, and may cause a refrigerant leak.

- Please be careful when bending the copper pipe.
- Screw in manually while adjusting the center. After that, use a torque wrench to tighten the connection.

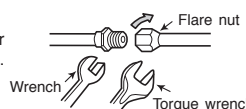

	Outer dia. of pipe	Torque N·m (kgf · cm)	
Small dia. side	6.35 (1/4")	14.0 - 18.0 (140 ~ 180)	
Large dia. side	9.52 (3/8")	33.0 - 42.0 (330 ~ 420)	
	12.70 (1/2")	50.0 - 62.0 (500 ~ 620)	
	15.88 (5/8")	63.0 - 77.0 (630 ~ 770)	
Valve head cap	Small dia. side	19.6 - 24.5 (200 ~ 250)	
	Large dia. side	9.52 (3/8")	19.6 - 24.5 (200 ~ 250)
		12.70 (1/2")	29.4 - 34.3 (300 ~ 350)
Valve core cap	15.88 (5/8")	29.0 - 31.0 (296 ~ 316)	
		12.3 - 15.7 (125 ~ 160)	

Gas Leakage Inspection

Please use gas leakage detector to check if leakage occurs at the connection of Flare nut as shown on the right. If gas leakage occurs, further tighten the connection to stop leakage.

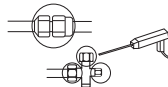

3 Heat Insulation and Finish of the Piping

- The connected terminals should be completed sealed with heat insulator and then tied up with rubber strap.
- Do not tie the terminals with the tape too tight. If any clearance or over-tightening may cause condensation.
- Please tie the pipe and power line together with vinyl tape as shown in the figure showing the installation of Indoor and Outdoor units.
- To enhance the heat insulation and to prevent water condensation, please cover the outdoor part of the drain hose and pipe with insulation pipe.
- Completely seal any gap with putty.

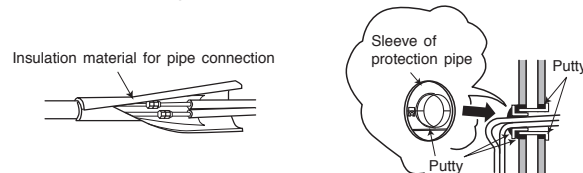

4 Installation of Drain Hose

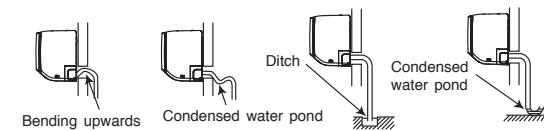

CAUTION

Be sure that the drain hose is not loosely connected or bend or proper condition like left figure.

CAUTION

You are free to choose the side (left or right) for the installation of drain hose. Please ensure the smooth flow of condensed water of the Indoor unit during installation. (Carelessness may result in water leakage.)

WARNING THIS APPLIANCE MUST BE EARTHED.

Detail of Cutting the Connecting Cord

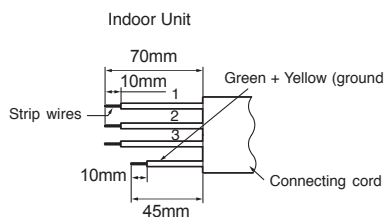

WARNING

- Leave some space in the connecting cord for maintenance purpose and be sure to secure it with the cord band.
- Secure the connecting cord along the coated part of the wire using the cord band. Do not exert pressure on the wire as this may cause overheating or fire.

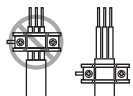

Wiring of The Indoor Unit

- For wire connection of the Indoor unit, you need to remove the front cover, the low cover under the body of the unit and terminal cover.
- Remove the cover from the terminal base and screw the cable.

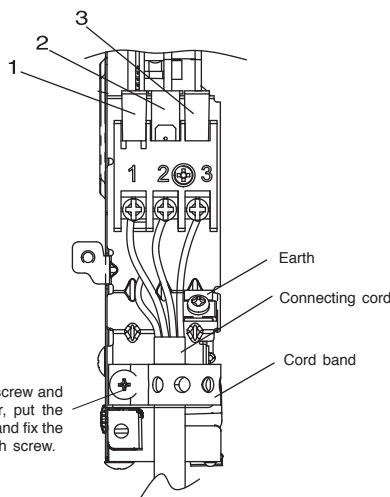

After remove the screw and the terminal cover, put the connecting cords and fix the terminal cover with screw.

Method to remove the low cover

- Pull at the 1 and 2 in the directions as shown by arrows to remove the cover.



How to connect the optional parts (H-LINK RAC Adapter, Dry contact, Wired Remote Controller)

- For cable connection to control P.W.B., you need to remove front cover and electrical box cover. Each connecting location is as below.
 - Dry contact: CN6
 - H-LINK RAC Adapter: CN7B
 - Wired Remote Controller: CN20
- Please check and confirm manuals attached to each optional parts for more connection details.
- Please check service manual about how to set from remote controller.
- You can refer to this installation manual how to remove and re-attach the front cover.
- Please be careful not to damage lead wires by edge of plate when connecting the optional parts.
- Please do the operation test after the connection.

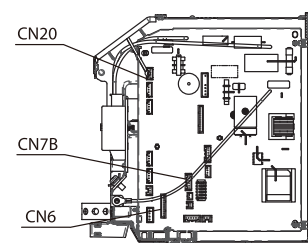

1 HOW TO REMOVE OR ATTACH THE FRONT COVER

How to Remove the Front Cover

- Remove the front panel

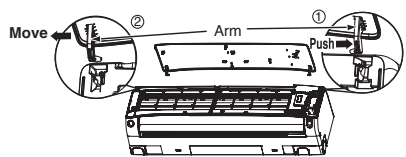

- Push the end of the right-side arm outward to release the tab.
- Move the left-side arm outward to release the left tab, and then pull the panel towards you.
- Remove the filters.
- After removing 3 screws, remove the cover of electric box, pull the center of the front cover towards you and release the claws.
- Pull the side faces (lower sections) of the front cover towards you as shown in the figure and remove the cover.

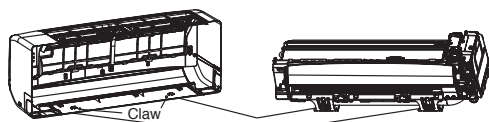

How to Attach the Front Cover

- After installing the front cover onto the unit, hook three claws at upper side of the cover securely. Then, push the center of the front cover to lock the claws.
- Assemble the cover of electric box.
- Tighten the 3 screws.
- Install the filter.
- Attaching the Front Panel
 - Insert the shaft of the left arm along the step on the unit into the hole.
 - Securely insert the shaft of the right arm along the step on the unit into the hole.
 - Make sure that the front panel is securely attached, and then close the front panel.

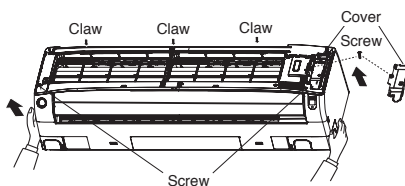

2 HOW TO REMOVE INDOOR UNIT

- Push up the (PUSH) sections at the bottom of the indoor unit and pull the bottom plate towards you. Then the claws are released from the stationary plate. (The (PUSH) sections are indicated by 2 arrows as below figure)

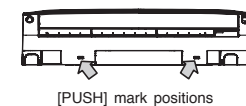

[PUSH] mark positions

CAUTION

