



Ducted Packaged Units

Technical Data

OPA 1410/1710/2110 Econex Series R32



Cooling Capacity
11.8kW – 239kW



Heating Capacity
12.9kW – 244kW



Packaged Rooftop Air Conditioners R32

OPA 1410/1710/2110 Econex Series

OPA 1410–2110 LKT SERIES	
General	3
Applications	4
Features	
Lower GWP	4
Economy	4
Efficient	4
Better Comfort	4
Intelligence	4
Quiet	5
Durable	5
Easy Access	5
Improves Indoor Air Quality	5
Low Maintenance	5
Inverter Compressor	5
Soft Starting	5
Insulation	5
Control Option	5
Extended Capability	5
System Protection Features	5
Self Diagnostics	6
Wiring	6
Plant Room Use	6
Configurations	6
Optional Equipment	6
Economiser	6
Econex vs Econex Pro	6

CONTROLS	
TZT-100 Controller (Optional)	7
Advanced Controller	8

PERFORMANCE DATA	
Cooling Capacity (kW)	9
Heating Capacity (kW)	15
Indoor Air Flow Correction Factors	15
Air Handling	18
Sound Levels	19

DIMENSIONS	
	23

SPECIFICATIONS	
Nomenclature	32
Contact Us	36



Overview brochure available

- Other relevant documents:
- Specification Sheets
 - Part Load Performance Data
 - Installation & Maintenance



Packaged Rooftop Air Conditioners R32

OPA 1410/1710/2110 Econex

Econex Packaged rooftop HVAC units provide the ultimate flexibility and performance demanded in open plan commercial environments.

Econex Key benefits:

- energy efficiency
- low start-up current (just 10 amps)
- wide operating range: -10°C to $+50^{\circ}\text{C}$ ambient conditions
- potential for 'free' cooling using Economiser option
- reliability and durability inherent in a Temperzone assembled packaged unit

Econex Pro Additional benefits:

- integrated controls
- intelligent software to suit changing conditions
- enhanced energy efficiency
- additional control options



Packaged Rooftop Air Conditioners R32

OPA 1410/1710/2110 Econex

Applications

Specifically developed for air conditioning of large commercial premises, eg retail warehouses, supermarkets, shopping malls, educational facilities, sports venues, exhibition centres, industrial process facilities and auditoriums.

Features

Lower GWP

Utilising R32 Refrigerant, Temperzone's Econex Packaged Units enable a 75-80% reduction of Global Warming Potential (GWP) per kW of cooling when compared to R410A units.

Economy

Each **Econex** unit in this series use **one** variable capacity inverter and **three** fixed speed compressor.

Each **Econex Pro** unit in this series uses **four** variable capacity inverter compressors, which generally use less energy than alternative types of compressor. Four independent refrigeration systems from one master controller enables redundancy for critical applications, ie if one system was down, the others would continue to operate*.

Efficient

As most air conditioners operate at part load for the vast majority of the time, it makes sense for each unit to incorporate one or more inverter scroll compressors which are very efficient at part load.

Part load efficiency can be even further enhanced by indoor fan part load operation at low loads (eg 75% airflow equates to 55% power use).

Each plug fan incorporates a high efficiency electronically commutated (EC) motor (up to 25% more efficient;

significantly better than belt drive centrifugal fans).

Large heat exchange coils incorporate inner grooved (rifled) tube for better heat transfer.

Better Comfort

Variable speed technology enables fine tuning of the system – which ultimately delivers temperature stability and therefore better comfort to the occupants in the air conditioned space.

Intelligence

Econex Pro incorporates intelligent technology. Its software understands the surrounding environment and self-adjusts to maintain required temperature and humidity levels.

The unit can operate to: (1) maximise part-load efficiency, (2) maximise performance, or (3) Balance efficiency and performance.

The variable capacity inverter compressor technology can provide close comfort control of the room temperature. Each OPA unit has capacity higher than its nominal available for fast response when well away from set point at start-up, and an energy saving low capacity turn-down.

Econex/EconexPro feature a dynamically balanced backward curved fan with a variable speed EC motor. This variability

enables fine tuning to match the supply air requirements. These EC motor fans have a fully integrated speed control that enables soft starting. Fan speed can be stepped to your own requirements or continuously variable using a 0–10V DC control signal.

The system also includes a temperature sensing head pressure control which enables the system to compensate for outdoor ambient temperatures below 20°C on cooling cycle, and above 15°C on heating cycle.

* Not applicable to Econex



Packaged Rooftop Air Conditioners R32

OPA 1410/1710/2110 Econex

Features

Quiet

Each integral high efficiency EC fan motor can vary from zero to full speed. This allows slow ramp up with no sudden noise change.

The outdoor coil design permits low fan speeds and hence low noise levels. The compressors are isolated in a built-in, insulated compartment to minimise noise. The indoor air section is also insulated for noise attenuation, thermal protection of the air stream and to minimise exterior condensation.

Durable

The cabinet is constructed from high grade galvanised steel - baked polyester powder coated (to AS 4506:2005; colour Grey) for all weather protection (IP44 / IPX4¹). External fasteners are marine grade SKT® coated steel. The units include a baked polyester powder coated internal condensate drain tray. Heat exchange coils comprise aluminium corrugated plate fins on mechanically expanded rifled copper tube. Both the indoor and outdoor coils' fins are pre-epoxy coated for extra protection in corrosive environments, e.g. salt laden sea air. Fan motor bearings are sealed for life so as not to incur regular maintenance. Coil protection guards protect against hail, accidental damage or vandalism.

Easy Access

These packaged units are designed to be installed outdoors, where routine service and maintenance access is relatively easy during operating hours. Service panels are hinged with turn locks for ease of access.

Improves Indoor Air Quality

Air filtration helps clean the air in occupied space. The unit's filter frame holds 50 or 100 mm thick panel filter sizes. The indoor air fan ventilates building by distributing conditioned air throughout the building, with option for fresh air introduction via Economiser Kit.

Low Maintenance

Commissioning and maintenance costs are reduced through use of a fan that requires no pulley and belt adjustments or changes like traditional fans. A controlled outdoor section drainage system directs water to a drainage point and prevents pooling of water inside the unit.

Inverter Compressor

Each high efficiency variable capacity inverter compressor is hermetically sealed, quiet running and supported on rubber mounts to minimise vibration. Inverter compressors provide the economy of part load performance.

Soft Starting

EC motors and inverter compressors are soft starting therefore have none of the problems associated with high in-rush current ².

Insulation

Closed cell foam insulation has been used in the indoor air section to ensure no particles are introduced into the air stream. Both indoor and outdoor chambers are insulated to prevent external condensation forming on the cabinet exterior. The insulation is foil faced and meets fire test standards AS 1530.3 (1989) and BS 476 parts 6 & 7.

Unit Control System

Econex: The control system is comprised of four Temperzone UC8 controllers, one for each individual system. The master UC8 controller looks after factory settings, staging of the compressors, status reporting, and alarms display. An external controller is also required.

Econex Pro: The control system is comprised of one *Carel c.pCO* master controller and four Temperzone UC8 slave controllers, one for each individual system. The master controller looks after the setpoints, operation modes, factory settings, staging of the compressors, status reporting, scheduling, BMS settings and alarms display. The unit's

fully integrated controls enable it to operate as a 'stand alone' unit.

An optional *Carel pGD1* (pn 201-000-379) wired remote display is available for location up to 50m from the unit – enabling easier servicing, including setpoint adjustment.

Control Option

Econex Pro: Air flow can be maintained through use of the supplied differential pressure transducer and controller to compensate for varying duct static pressures caused by dirty filters or modulating dampers. Commissioning is made easier.

Econex/Econex Pro: The EC plug fan motor is controlled variably (within a restricted range, p10) by a 0–10 volt DC signal that can be supplied either by a BMS system, or the internal *c.pCO* Controller (Pro only).

The units are BMS compatible, with multi-unit control possible – via Modbus RTU, Modbus TCP/IP ³ or BACnet/IP ³. Refer to Temperzone for other protocols available. Units can also be run as turn-key operation with no BMS connection required.

Extended Capability

Inverters are particularly suitable for applications requiring high proportions of fresh air, VAV, close control. Supply air temperature control is also possible using BMS or other controls. Refer to Temperzone for capacity range variation options.

System Protection Features

1. HP and loss of refrigerant protection.
2. Anti-rapid cycle timer and internal overload for compressor protection.
3. Circuit breaker control circuits.
4. Time-and-temperature controlled electronic de-ice switch prevents icing up of the outdoor coil during heating cycle.
5. Frost protection on cooling cycle.
6. Sensor fault indication.
7. Crankcase heater prevents liquid

¹ Outdoor fan-guard clearance <100 mm (ref. IEC 60529)

² Econex units start using inverter compressor

³ BACnet on Econex requires a suitable gateway controller



Packaged Rooftop Air Conditioners R32

OPA 1410/1710/2110 Econex

Features

- refrigerant condensing in the compressors during the "off" cycle. Compressor minimum run time to ensure oil return.
- 8. Automatic oil flush cycle to protect compressors.
- 9. High level inverter protection.
- 10. Self diagnostic reporting.
- 11. 12V control circuit.

Note: Consideration must be given to the minimum floor area requirements of R32 refrigerant (refer Installation manual).

Self Diagnostics

Each Unit Controller (UC8) has a LED display to indicate faults and running conditions. No need to connect pressure gauges. **Econex:** A non-specific/common fault indicator is included for interface to external systems. **Econex Pro:** Faults can be displayed on the master controller³.

Compact

This type of air conditioner is compact and self-contained in comparison to Split Systems which require long interconnecting piping.

Wiring

The electrical supply required is: 3 phase 400 V a.c. 50 Hz with neutral and earth. The compressor crankcase heater requires a 24 hr power supply

The control panel is fully wired ready to accept the main power supply. Each system complies with the requirements of the Regulatory Compliance Mark (RCM) for electrical safety (AS/NZS 60335.2.40) and EMC (AS/NZS CISPR.14).

For your convenience, a single phase auxiliary power outlet (10A) is included in the electrical box.

Plant Room Use

Each unit is supplied with a high static (125 Pa) condenser fan. Nominal outdoor airflow and correct unit clearances, along with no air recirculation, must be maintained in order for the unit to achieve its performance specification.

Configurations

1. Horizontal supply & return air versions
2. Downward supply & return air versions
3. Opposite hand versions of the above.
4. Other configurations available on request.
5. Integrated Hot Gas Reheat coil³

Optional Equipment

1. Filters (G4) rated to AS1324.1.2001 - disposable or washable¹, 50 mm thick. (Filter frame holds 50 or 100 mm).
2. TZT-100 wired wall t/stat control^{2,4}
3. Remote Service Interface Display (pGD1)³ – can be located up to 50m from unit using a 6 wire RJ12 telephone cable (not supplied)
4. Economiser – includes factory fitted dampers c/w motors and site fit fresh air cowl.
5. Electronic control systems for temperature and economiser (economy cycle)³.
6. Spill Air – includes factory fitted dampers c/w motors and site fit spill air cowl.
7. Controller expansion module to accommodate external water valves and additional temperature, humidity and/or CO₂ sensors³.
8. BACnet gateway controller (supplied separately)²

Economiser Option

If the outdoor air heat content or wet bulb temperature (dry bulb not recommended) is below that of the return air, the fresh air damper opens and the return air damper closes to provide cooling. Operating costs are reduced as free cooling is obtained. (Note: A separate spill air facility in the building may be necessary for when the return air damper is closed.) Fresh air dampers close to a minimum setting and return air dampers open before normal compressor operation resumes.

This option for **Econex** units includes dampers c/w motors and cowl; controls by others.

This option for **Econex Pro** units includes dampers c/w motors, cowl, indoor/outdoor temperature/humidity sensors and Economy Cycle control function.

Reheat Coil options³

Econex Pro units can be supplied with (1) an integrated hot gas reheat coil in combination with modulating control valves to regulate the the relative humidity level of the supply air – important in supermarket applications, for eliminating condensation in ductwork and in refrigeration cabinets. (2) Where waste heat is available an external hot water coil can be put in the supply air ductwork. The unit can control a modulating water valve to utilise this heat for first stage heating or re-heating.

¹ Check with your local branch for availability.

² Econex version only.

³ Econex Pro version only.

⁴ Not suitable for controlling Economiser dampers

Key Differences

Feature	OPA 1410–2110 Econex	OPA 1410–2110 Econex Pro
Compressors	Inverter + Fixed x3	Inverter x4
Temperature Controller	TZT-100 option	Carel c.pCO
Remote Temp Sensor	Option	Std
Intelligent Adaptive Software**	No	Yes
BACnet/IP	Via Modbus - BACnet Gateway	Yes
Economy Cycle Control	External controls By Others	Std with Economiser option
CO ₂ Sensing	External controls By Others	Option

** Includes Comfort modes and Humidity Control



Packaged Rooftop Air Conditioners R32

Econex Controls

TZT-100 Controller (Optional)



Features

- Cool / Cool Dry / Heat / Auto Dry / Auto / Fan Only modes
- Auto / High / Medium / Low fan speed selection. (customisable)
- Temperature setting range from 1°C – 38°C
- LED to indicate status of the unit [Power On/Off]
- Room & set temperature display
- Real time clock
- 12 or 24 hour time display
- °C or °F display
- **7 day timer** – up to two events (four start and/or stops per day)
- On demand countdown run timer, up to 9 hours.
- Auto-Restart or No Restart after power failure
- Continuous or Intermittent selection of fan run-on in dead zone
- Backlit screen for ease of reading
- Soft touch tab keys
- PIN protected menus (Installer PIN)
- Keypad and/or temperature lock
- Filter monitor option (by hours)
- Occupancy sensor inputs
- Integrated Modbus option
- Battery backup (Lithium)
- **Night mode** – temperature set back saves energy
- Audible beep to acknowledge key entry or wireless remote control
- 24V control cable
- Optional remote air temperature sensor

Optional:

Remote return air sensor

For more information visit www.temperzone.biz; model search 'TZT-100'

Note: TZT-100 is not suitable for Econex Pro units and is not designed to control an Economiser.



Packaged Rooftop Air Conditioners R32

Econex Pro Controller

Carel c.pCO Advanced Controller

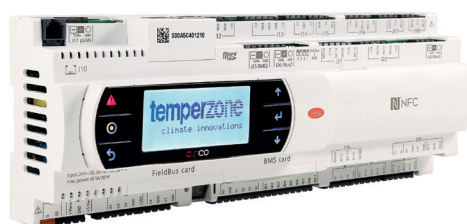

Features

- Adaptive technology ensures that **Econex Pro** is flexible, versatile and extremely user-friendly.
- Fully integrated controls that control every function of the unit.
- Pre-programmed optimisation and comfort modes.
- Intelligent humidity control.
- Built-in controller display enables quick set-up and functions display.
- Room temperature and humidity sensor supplied loose.
- Return and supply air sensors factory fitted.
- Fresh air temp/humidity sensor supplied for units with Economiser.
- Single and averaging temperature sensor options
- Indoor fan can be controlled to a constant speed or to a constant airflow using built-in airflow measurement.
- Occupancy offset – set back the room temperature during unoccupied periods to maintain space temperature to a wider range.
- Reduce the indoor fan speed during unoccupied times minimising energy use.
- Night/Quiet Mode, reduces noise levels when mode activated.
- Daily scheduled times for the unit's on/off operation can be programmed – up 4 events per day 7 days plus holidays.
- Individual time clock available to turn on night mode or unoccupied mode removing the need for end-user intervention – independent of the 24/7 time clock.
- Economy Cycle – control of outdoor air and return air dampers using enthalpy. *Optional accessory.
- Spill Air – control of optional Spill Air damper to balance incoming fresh air.
- Security – Multi-level control & password (Mfg/Service/User).
- Service Interface screen with data log features and alarms; USB exportable file.
- Refrigeration systems information available, including power monitoring, via display and optionally via BACnet/IP and Modbus/RTU communications.
- Quick Start-up user settings.
- Dirty air filter indicator; adjustable
- Blocked condensate drain alert
- Remote on/off (enable)
- Battery backup of settings (PCB)
- Expansion module available to accept provide additional functionality, eg CO₂ sensor/s (single or averaging), external water valves control.
- Tempering control of supply air during cooling dehumidification (with reheat coil application)
- Optional remote wired Service Interface display (pGD1).



Packaged Rooftop Air Conditioners R32

OPA 1410 Performance Data

Cooling Capacity (kW)

- TC = Total Capacity (kW)
- SC = Sensible Capacity (kW)
- PI = Power Input (kW)
- EAT = Entering Air Temperature
- = Nominal Capacity (kW)

Nominal Air Flow: **8 100 l/s**

Note: Capacities are **gross** and do not include allowance for fan motor heat loss.

OPA 1410 Econex @Nominal Capacity (8 100 l/s)

Indoor coil
E.A.T.

Outdoor coil Entering Air Temperature °C DB

D.B. °C	W.B. °C	20			25			30			35			40			45			50		
		TC	SC	PI	TC	SC	PI	TC	SC	PI	TC	SC	PI	TC	SC	PI	TC	SC	PI	TC	SC	PI
20	14	136.1	100.7	34.4	132.1	100.1	37.8	127.8	99.1	41.4	125.9	100.0	44.5	121.0	98.2	48.7	119.3	99.0	52.3	115.7	98.1	56.7
	15	141.3	91.8	34.6	137.1	91.0	38.0	132.6	89.8	41.7	130.6	90.2	44.9	125.5	88.3	49.2	123.6	88.8	52.8	119.8	87.6	57.3
	16	146.8	81.9	34.7	142.5	80.7	38.3	137.8	79.3	42.0	135.6	79.3	45.3	130.2	77.2	49.6	128.2	77.3	53.3	124.1	75.9	57.9
	17	152.7	70.5	34.9	148.2	69.0	38.5	143.2	67.3	42.4	140.9	66.9	45.6	135.2	64.7	50.1	133.0	64.2	53.8	128.7	62.7	58.5
22	16	144.8	101.8	34.7	140.5	101.1	38.2	135.9	100.0	41.9	133.8	100.7	45.1	128.5	98.8	49.4	126.5	99.5	53.1	122.5	98.4	57.6
	17	150.0	92.7	34.8	145.5	91.7	38.4	140.7	90.4	42.2	138.4	90.7	45.5	132.9	88.6	49.9	130.8	88.9	53.6	126.6	87.6	58.2
	18	155.5	82.4	35.0	150.8	81.2	38.6	145.7	79.6	42.5	143.3	79.5	45.8	137.5	77.3	50.3	135.3	77.2	54.1	130.9	75.7	58.8
	19	161.3	70.8	35.1	156.4	69.2	38.8	151.1	67.4	42.8	148.6	66.8	46.2	142.5	64.5	50.7	140.1	64.0	54.6	135.5	62.3	59.4
24	16	144.4	118.7	34.7	140.1	118.4	38.2	135.5	117.6	41.9	133.4	118.9	45.1	128.1	117.0	49.4	126.1	118.2	53.0	122.2	116.4	57.6
	18	153.7	102.9	34.9	149.1	102.1	38.5	144.1	100.9	42.4	141.8	101.5	45.7	136.0	99.5	50.2	133.8	100.0	53.9	129.5	98.7	58.6
	20	164.3	82.8	35.2	159.3	81.4	38.9	153.9	79.8	42.9	151.3	79.6	46.4	145.1	77.2	51.0	142.6	77.0	54.8	137.8	75.4	59.7
	21	170.1	71.0	35.3	164.9	69.3	39.1	159.2	67.4	43.2	156.5	66.7	46.7	150.0	64.3	51.4	147.4	63.7	55.3	142.4	61.9	60.2
26	17	149.3	127.4	34.8	144.8	127.2	38.4	140.0	126.4	42.2	137.8	127.9	45.4	132.2	126.0	49.8	130.2	124.5	53.5	126.0	120.4	58.1
	19	158.0	112.7	35.0	153.3	112.0	38.7	148.1	110.9	42.6	145.7	111.8	46.0	139.7	109.7	50.5	137.4	110.4	54.3	132.9	109.1	59.0
	20	162.8	104.0	35.1	157.9	103.1	38.9	152.6	101.8	42.9	150.0	102.3	46.3	143.8	100.0	50.9	141.4	100.4	54.7	136.7	99.0	59.5
	22	173.4	83.2	35.3	168.1	81.7	39.2	162.3	80.0	43.4	159.5	79.7	46.9	152.8	77.2	51.6	150.1	76.9	55.6	145.0	75.2	60.6
27	18	153.9	128.5	34.9	149.2	128.2	38.5	144.3	127.4	42.4	141.9	128.9	45.7	136.2	126.9	50.2	134.0	128.0	53.9	129.6	124.0	58.6
	19	158.2	121.3	35.0	153.4	120.8	38.7	148.3	119.8	42.6	145.7	122.8	46.0	139.9	118.9	50.5	137.5	119.8	54.3	133.0	118.6	59.0
	20	162.7	113.4	35.1	157.7	112.7	38.9	152.4	111.5	42.9	149.8	112.3	46.3	143.7	110.1	50.9	141.3	110.8	54.7	136.6	109.4	59.5
	22	172.6	94.5	35.3	167.3	93.3	39.2	161.6	91.7	43.3	158.7	91.8	46.8	152.1	89.4	51.6	149.4	89.4	55.5	144.3	87.8	60.5
28	18	154.5	136.0	34.9	149.9	135.9	38.6	144.9	135.2	42.4	142.5	136.5	45.8	136.7	131.1	50.2	134.5	128.9	54.0	130.2	124.5	58.7
	20	162.9	122.1	35.1	158.0	121.5	38.9	152.6	120.5	42.9	150.0	121.6	46.3	143.9	119.4	50.9	141.4	120.3	54.7	136.7	119.1	59.5
	22	172.2	105.0	35.3	166.9	104.0	39.2	161.2	102.6	43.3	158.4	103.0	46.8	151.8	100.6	51.6	149.1	100.9	55.5	144.0	99.3	60.4
	24	182.6	83.7	35.5	177.0	82.1	39.5	170.9	80.2	43.8	167.8	79.8	47.4	160.7	77.3	52.3	157.8	76.9	56.4	152.3	75.1	61.4
30	19	160.3	144.5	35.1	155.4	144.5	38.8	150.2	143.9	42.7	147.7	142.0	46.1	141.6	136.0	50.7	139.3	133.6	54.5	134.7	129.0	59.3
	21	168.2	131.3	35.3	163.1	130.9	39.1	157.5	129.9	43.1	154.8	131.2	46.6	148.4	129.0	51.3	145.8	130.1	55.2	140.9	128.8	60.0
	23	177.0	115.2	35.4	171.6	114.3	39.4	165.7	113.0	43.5	162.7	113.6	47.1	155.9	111.3	51.9	153.1	111.7	55.9	147.8	110.2	60.9
	25	186.8	95.5	35.6	181.0	94.1	39.6	174.7	92.4	44.0	171.6	92.3	47.6	164.3	89.7	52.6	161.2	89.6	56.7	155.6	87.8	61.8
32	21	170.1	147.0	35.3	164.9	147.0	39.1	159.2	146.2	43.2	156.5	148.0	46.7	150.0	144.3	51.4	147.4	141.7	55.3	142.4	136.7	60.2
	23	178.0	133.1	35.4	172.5	132.7	39.4	166.6	131.6	43.6	163.6	132.8	47.1	156.8	130.4	52.0	153.9	131.4	56.0	148.6	130.0	61.0
	25	186.8	116.3	35.6	181.0	115.4	39.6	174.7	114.0	44.0	171.6	114.6	47.6	164.3	112.1	52.6	161.2	112.4	56.7	155.6	110.8	61.8
	26	191.6	106.6	35.6	185.6	105.5	39.8	179.2	103.8	44.2	175.9	104.0	47.9	168.3	101.5	52.9	165.2	101.5	57.1	159.3	99.8	62.3



Packaged Rooftop Air Conditioners R32

OPA 1410 Performance Data

Cooling Capacity (kW)

- TC = Total Capacity (kW)
- SC = Sensible Capacity (kW)
- PI = Power Input (kW)
- EAT = Entering Air Temperature
- = Nominal Capacity (kW)

Nominal Air Flow: **8 100 l/s**

Note: Capacities are **gross** and do not include allowance for fan motor heat loss.

OPA 1410 Econex Pro @Nominal Capacity (8 100 l/s)

Indoor coil E.A.T.		Outdoor coil Entering Air Temperature °C DB																				
D.B. °C	W.B. °C	20			25			30			35			40			45			50		
		TC	SC	PI	TC	SC	PI	TC	SC	PI	TC	SC	PI	TC	SC	PI	TC	SC	PI	TC	SC	PI
20	14	142.4	104.3	33.7	139.0	104.3	36.9	135.2	104.0	40.2	131.2	103.2	43.8	126.9	102.1	47.7	122.3	100.5	52.0	117.3	98.5	56.6
	15	147.8	95.0	33.9	144.2	94.6	37.1	140.3	94.0	40.5	136.1	93.0	44.2	131.6	91.7	48.1	126.7	90.0	52.4	121.6	87.9	57.2
	16	153.4	84.4	34.0	149.7	83.7	37.3	145.6	82.8	40.8	141.2	81.5	44.5	136.5	80.0	48.5	131.5	78.2	52.9	126.1	76.0	57.7
	17	159.5	72.4	34.1	155.5	71.3	37.5	151.3	70.0	41.0	146.7	68.5	44.8	141.8	66.8	48.9	136.5	64.8	53.4	130.9	62.6	58.3
22	16	151.3	105.3	34.0	147.6	105.2	37.2	143.6	104.8	40.7	139.3	103.9	44.4	134.7	102.7	48.4	129.7	101.0	52.7	124.4	98.8	57.5
	17	156.6	95.6	34.1	152.8	95.2	37.4	148.6	94.5	40.9	144.1	93.4	44.7	139.3	92.0	48.7	134.2	90.2	53.2	128.7	88.0	58.0
	18	162.2	84.8	34.2	158.2	84.0	37.6	153.9	83.0	41.1	149.2	81.6	45.0	144.2	80.0	49.1	138.8	78.1	53.6	133.1	75.9	58.5
	19	168.2	72.6	34.3	164.0	71.4	37.7	159.4	70.0	41.4	154.6	68.4	45.3	149.4	66.6	49.5	143.8	64.5	54.1	137.9	62.3	59.0
24	16	150.9	122.9	33.9	147.2	123.4	37.2	143.2	123.3	40.6	138.9	122.8	44.3	134.3	121.8	48.3	129.4	120.2	52.7	124.1	118.1	57.5
	18	160.4	106.3	34.2	156.5	106.1	37.5	152.2	105.5	41.1	147.6	104.6	44.9	142.6	103.3	49.0	137.3	101.5	53.5	131.7	99.3	58.4
	20	171.3	85.0	34.4	167.0	84.1	37.8	162.4	83.0	41.5	157.4	81.6	45.4	152.1	79.9	49.7	146.4	77.9	54.3	140.3	75.6	59.3
	21	177.1	72.6	34.5	172.7	71.3	38.0	167.9	69.8	41.7	162.7	68.1	45.7	157.2	66.2	50.0	151.3	64.1	54.7	145.0	61.8	59.8
26	17	155.9	131.9	34.1	152.1	132.5	37.4	147.9	132.6	40.9	143.4	132.2	44.6	138.7	131.2	48.7	133.5	127.8	53.1	128.1	122.3	57.9
	19	164.9	116.3	34.2	160.8	116.4	37.6	156.3	116.0	41.3	151.6	115.2	45.1	146.5	113.9	49.3	141.0	112.2	53.8	135.2	109.9	58.8
	20	169.8	107.1	34.3	165.5	106.9	37.8	160.9	106.2	41.5	156.0	105.2	45.4	150.7	103.8	49.6	145.1	101.9	54.2	139.1	99.6	59.2
	22	180.5	85.3	34.5	176.0	84.3	38.1	171.0	83.0	41.9	165.8	81.5	45.9	160.1	79.8	50.2	154.1	77.7	55.0	147.7	75.3	60.1
27	18	160.6	132.9	34.2	156.6	133.5	37.5	152.3	133.5	41.1	147.7	133.0	44.9	142.8	132.0	49.0	137.5	130.4	53.5	131.8	126.1	58.4
	19	165.0	125.3	34.2	160.9	125.5	37.7	156.5	125.4	41.3	151.7	124.7	45.1	146.6	123.6	49.3	141.2	121.8	53.8	135.3	119.6	58.8
	20	169.6	116.9	34.3	165.4	116.9	37.8	160.8	116.5	41.4	155.9	115.6	45.4	150.6	114.3	49.6	145.0	112.5	54.2	139.0	110.2	59.2
	22	179.7	97.1	34.5	175.1	96.4	38.1	170.3	95.4	41.8	165.0	94.2	45.8	159.4	92.5	50.2	153.4	90.5	54.9	147.0	88.2	60.0
28	18	161.3	140.8	34.2	157.3	141.5	37.5	153.0	141.7	41.1	148.3	141.4	44.9	143.4	137.6	49.0	138.0	132.3	53.5	132.4	126.7	58.4
	20	169.8	126.0	34.3	165.6	126.2	37.8	161.0	126.0	41.5	156.1	125.3	45.4	150.8	124.1	49.6	145.2	122.3	54.2	139.2	120.0	59.2
	22	179.3	108.0	34.5	174.7	107.6	38.0	169.9	106.9	41.8	164.6	105.8	45.8	159.0	104.3	50.2	153.1	102.3	54.9	146.7	100.0	60.0
	24	189.9	85.6	34.6	185.1	84.5	38.3	179.9	83.2	42.2	174.3	81.6	46.3	168.3	79.8	50.8	161.9	77.6	55.6	155.2	75.2	60.8
30	19	167.1	149.5	34.3	163.0	150.4	37.7	158.5	150.7	41.3	153.6	147.9	45.2	148.5	142.7	49.4	142.9	137.2	54.0	137.0	131.3	59.0
	21	175.2	135.5	34.4	170.8	135.9	37.9	166.1	135.8	41.7	161.0	135.2	45.6	155.5	134.1	49.9	149.7	132.3	54.6	143.5	129.9	59.7
	23	184.2	118.4	34.6	179.5	118.3	38.2	174.5	117.8	42.0	169.1	116.8	46.1	163.3	115.4	50.4	157.2	113.4	55.2	150.6	111.0	60.4
	25	194.2	97.7	34.7	189.2	96.9	38.4	183.9	95.9	42.3	178.1	94.4	46.5	172.0	92.7	51.0	165.5	90.6	55.9	158.6	88.2	61.2
32	21	177.1	151.8	34.5	172.7	152.7	38.0	167.9	152.9	41.7	162.7	152.6	45.7	157.2	151.4	50.0	151.3	145.5	54.7	145.0	139.3	59.8
	23	185.2	137.1	34.6	180.5	137.5	38.2	175.4	137.3	42.0	170.0	136.7	46.1	164.2	135.4	50.5	158.0	133.6	55.3	151.4	131.2	60.5
	25	194.2	119.4	34.7	189.2	119.2	38.4	183.9	118.6	42.3	178.1	117.6	46.5	172.0	116.1	51.0	165.5	114.1	55.9	158.6	111.6	61.2
	26	199.0	109.2	34.7	193.9	108.7	38.5	188.4	107.8	42.5	182.5	106.6	46.7	176.2	104.9	51.3	169.6	102.9	56.2	162.5	100.4	61.6



Packaged Rooftop Air Conditioners R32

OPA 1710 Performance Data

Cooling Capacity (kW)

- TC = Total Capacity (kW)
- SC = Sensible Capacity (kW)
- PI = Power Input (kW)
- EAT = Entering Air Temperature
- = Nominal Capacity (kW)

Nominal Air Flow: **8 200 l/s**

Note: Capacities are **gross** and do not include allowance for fan motor heat loss.

OPA 1710 Econex @Nominal Capacity (8 200 l/s)

Indoor coil
E.A.T.

Outdoor coil Entering Air Temperature °C DB

D.B. °C	W.B. °C	20			25			30			35			40			45			50		
		TC	SC	PI	TC	SC	PI	TC	SC	PI	TC	SC	PI	TC	SC	PI	TC	SC	PI	TC	SC	PI
20	14	162.1	110.6	39.8	157.3	110.2	43.5	152.2	109.3	47.4	146.6	108.0	51.7	140.6	106.0	56.3	133.9	103.3	61.3	126.6	99.7	66.8
	15	168.3	99.7	39.9	163.3	99.0	43.7	157.9	97.8	47.7	152.1	96.3	52.0	145.8	94.1	56.8	138.8	91.4	61.9	131.1	87.9	67.4
	16	174.9	87.4	40.1	169.7	86.3	43.9	164.0	84.9	48.0	157.9	83.1	52.4	151.2	80.9	57.2	143.9	78.1	62.4	135.8	74.8	68.1
	17	181.9	73.4	40.2	176.4	71.9	44.1	170.5	70.2	48.3	164.0	68.2	52.8	157.0	65.9	57.7	149.3	63.2	63.0	140.8	60.0	68.8
22	16	172.5	111.3	40.0	167.3	110.8	43.8	161.8	109.8	47.9	155.8	108.2	52.3	149.2	106.1	57.1	142.0	103.2	62.2	134.1	99.5	67.9
	17	178.6	100.0	40.1	173.3	99.1	44.0	167.5	97.9	48.1	161.2	96.2	52.6	154.3	93.9	57.5	146.8	91.0	62.8	138.5	87.4	68.5
	18	185.1	87.3	40.2	179.5	86.2	44.1	173.4	84.6	48.4	166.8	82.7	53.0	159.7	80.4	57.9	151.8	77.5	63.3	143.1	74.1	69.1
	19	192.0	73.0	40.3	186.1	71.5	44.3	179.8	69.7	48.6	172.9	67.6	53.3	165.4	65.1	58.4	157.1	62.3	63.8	148.1	59.1	69.8
24	16	172.0	131.4	40.0	166.8	131.3	43.8	161.3	130.7	47.8	155.3	129.4	52.3	148.8	127.3	57.0	141.6	124.3	62.2	133.7	120.3	67.8
	18	183.0	111.9	40.2	177.5	111.3	44.1	171.5	110.2	48.3	165.0	108.5	52.9	158.0	106.2	57.8	150.2	103.2	63.1	141.7	99.3	68.9
	20	195.6	87.1	40.4	189.6	85.8	44.4	183.1	84.2	48.8	176.0	82.2	53.5	168.3	79.7	58.6	159.9	76.7	64.1	150.7	73.2	70.1
	21	202.3	72.5	40.4	196.1	70.9	44.5	189.3	69.0	49.0	182.0	66.8	53.8	173.9	64.3	59.0	165.1	61.4	64.6	155.5	58.0	70.7
26	17	177.8	141.4	40.1	172.4	141.5	43.9	166.7	140.9	48.1	160.4	139.6	52.6	153.6	137.4	57.4	146.1	134.3	62.7	137.9	130.0	68.4
	19	188.2	123.2	40.3	182.4	122.7	44.2	176.2	121.7	48.5	169.5	120.1	53.1	162.2	117.8	58.1	154.2	114.6	63.5	145.3	110.5	69.4
	20	193.8	112.4	40.3	187.9	111.7	44.4	181.5	110.4	48.7	174.5	108.7	53.4	166.9	106.2	58.5	158.6	103.1	64.0	149.4	99.1	69.9
	22	206.2	86.8	40.5	199.8	85.4	44.6	192.9	83.7	49.1	185.4	81.6	54.0	177.2	79.0	59.2	168.2	76.0	64.9	158.3	72.3	71.0
27	18	183.2	142.3	40.2	177.7	142.3	44.1	171.7	141.7	48.3	165.2	140.3	52.9	158.1	138.1	57.8	150.3	134.8	63.1	141.8	130.4	68.9
	19	188.3	133.4	40.3	182.6	133.1	44.2	176.4	132.3	48.5	169.7	130.8	53.1	162.4	128.4	58.1	154.3	125.2	63.5	145.5	120.8	69.4
	20	193.6	123.6	40.3	187.7	123.1	44.4	181.3	122.0	48.7	174.3	120.4	53.4	166.7	117.9	58.5	158.4	114.7	64.0	149.3	110.5	69.9
	22	205.3	100.3	40.5	198.9	99.2	44.6	192.0	97.7	49.1	184.5	95.7	53.9	176.4	93.2	59.1	167.4	90.0	64.8	157.6	86.1	70.9
28	18	184.0	151.2	40.2	178.4	151.4	44.1	172.4	150.9	48.3	165.9	149.6	52.9	158.8	147.4	57.8	151.0	144.0	63.2	142.4	136.7	69.0
	20	193.9	133.9	40.3	188.0	133.6	44.4	181.5	132.7	48.7	174.6	131.1	53.4	167.0	128.7	58.5	158.6	125.4	64.0	149.5	121.0	69.9
	22	204.8	112.8	40.5	198.4	112.0	44.6	191.6	110.6	49.1	184.1	108.8	53.9	176.0	106.2	59.1	167.1	102.9	64.8	157.3	98.8	70.9
	24	217.1	86.6	40.6	210.3	85.1	44.8	202.9	83.3	49.4	194.9	81.1	54.4	186.1	78.5	59.8	176.6	75.3	65.6	166.1	71.6	71.9
30	19	190.8	160.9	40.3	185.0	161.2	44.3	178.7	160.8	48.6	171.8	159.5	53.2	164.4	157.1	58.3	156.2	150.5	63.7	147.2	141.7	69.6
	21	200.1	144.4	40.4	194.0	144.3	44.5	187.3	143.5	48.9	180.1	141.9	53.7	172.1	139.4	58.8	163.5	135.9	64.4	153.9	131.2	70.5
	23	210.5	124.5	40.5	203.9	123.8	44.7	196.8	122.6	49.2	189.1	120.8	54.1	180.7	118.2	59.4	171.5	114.7	65.2	161.4	110.3	71.4
	25	222.0	100.2	40.6	215.0	99.0	44.9	207.4	97.3	49.6	199.2	95.2	54.6	190.2	92.5	60.0	180.4	89.2	65.9	169.6	85.2	72.3
32	21	202.3	163.0	40.4	196.1	163.3	44.5	189.3	162.7	49.0	182.0	161.3	53.8	173.9	158.7	59.0	165.1	155.0	64.6	155.5	149.0	70.7
	23	211.6	145.8	40.5	205.0	145.6	44.7	197.9	144.7	49.3	190.1	143.0	54.2	181.7	140.3	59.5	172.4	136.7	65.3	162.2	131.8	71.5
	25	222.0	125.0	40.6	215.0	124.3	44.9	207.4	123.0	49.6	199.2	121.1	54.6	190.2	118.3	60.0	180.4	114.8	65.9	169.6	110.3	72.3
	26	227.5	113.1	40.6	220.3	112.1	45.0	212.5	110.6	49.7	204.1	108.5	54.8	194.8	105.7	60.3	184.7	102.2	66.3	173.6	97.9	72.8



Packaged Rooftop Air Conditioners R32

OPA 1710 Performance Data

Cooling Capacity (kW)

- TC = Total Capacity (kW)
- SC = Sensible Capacity (kW)
- PI = Power Input (kW)
- EAT = Entering Air Temperature
- = Nominal Capacity (kW)

Nominal Air Flow: **8 200 l/s**

Note: Capacities are **gross** and do not include allowance for fan motor heat loss.

OPA 1710 Econex Pro @Nominal Capacity (8 200 l/s)

Indoor coil E.A.T.		Outdoor coil Entering Air Temperature °C DB																				
D.B. °C	W.B. °C	20			25			30			35			40			45			50		
		TC	SC	PI	TC	SC	PI	TC	SC	PI	TC	SC	PI	TC	SC	PI	TC	SC	PI	TC	SC	PI
20	14	171.0	114.4	44.1	167.0	114.8	47.9	162.8	114.9	51.9	158.2	114.6	56.2	153.3	113.8	60.9	148.1	112.6	65.9	142.6	110.9	71.3
	15	177.6	102.8	44.3	173.4	102.8	48.2	169.0	102.5	52.3	164.2	101.9	56.7	159.1	100.9	61.4	153.7	99.5	66.5	147.9	97.8	72.0
	16	184.5	89.7	44.6	180.2	89.3	48.5	175.5	88.7	52.7	170.6	87.7	57.1	165.2	86.5	62.0	159.5	84.9	67.1	153.5	83.0	72.6
	17	191.9	74.9	44.8	187.4	74.0	48.8	182.5	72.9	53.0	177.3	71.6	57.6	171.8	70.1	62.5	165.8	68.3	67.7	159.5	66.3	73.4
22	16	182.0	115.0	44.5	177.7	115.3	48.4	173.1	115.3	52.5	168.2	114.9	57.0	163.0	114.0	61.8	157.4	112.7	66.9	151.4	110.9	72.4
	17	188.5	103.0	44.7	184.0	102.9	48.6	179.3	102.5	52.9	174.2	101.8	57.4	168.7	100.7	62.3	162.9	99.3	67.5	156.7	97.4	73.0
	18	195.3	89.6	44.9	190.7	89.1	48.9	185.8	88.3	53.2	180.4	87.3	57.8	174.7	85.9	62.8	168.7	84.3	68.0	162.2	82.3	73.7
	19	202.7	74.4	45.1	197.8	73.4	49.2	192.7	72.2	53.6	187.1	70.8	58.3	181.2	69.2	63.3	174.8	67.4	68.6	168.1	65.4	74.4
24	16	181.4	136.2	44.5	177.2	137.2	48.3	172.6	137.7	52.5	167.7	137.7	56.9	162.5	137.1	61.7	156.9	136.0	66.8	151.0	134.3	72.3
	18	193.2	115.5	44.8	188.6	115.8	48.8	183.7	115.7	53.1	178.4	115.1	57.7	172.8	114.2	62.6	166.8	112.8	67.9	160.4	110.9	73.5
	20	206.5	89.2	45.2	201.6	88.6	49.3	196.3	87.7	53.8	190.6	86.6	58.5	184.5	85.2	63.5	178.1	83.5	68.9	171.2	81.4	74.7
	21	213.7	73.7	45.3	208.6	72.7	49.6	203.1	71.4	54.1	197.2	69.9	58.9	190.9	68.3	64.0	184.1	66.4	69.5	177.0	64.3	75.3
26	17	187.6	146.7	44.6	183.1	147.9	48.6	178.4	148.6	52.8	173.3	148.7	57.3	167.9	148.3	62.2	162.1	147.2	67.4	155.9	145.5	72.9
	19	198.6	127.3	45.0	193.9	127.9	49.0	188.8	128.0	53.4	183.4	127.7	58.0	177.6	126.9	63.0	171.4	125.5	68.3	164.8	123.6	74.0
	20	204.6	115.9	45.1	199.7	116.1	49.3	194.5	115.9	53.7	188.9	115.3	58.4	182.9	114.3	63.4	176.5	112.8	68.8	169.7	110.8	74.5
	22	217.9	88.8	45.4	212.6	88.1	49.7	207.0	87.2	54.3	201.0	86.0	59.1	194.5	84.5	64.3	187.7	82.7	69.8	180.3	80.6	75.7
27	18	193.4	147.6	44.8	188.8	148.8	48.8	183.9	149.4	53.1	178.6	149.5	57.7	173.0	149.1	62.6	167.0	147.9	67.9	160.6	146.1	73.5
	19	198.8	138.1	45.0	194.1	139.0	49.0	189.0	139.3	53.4	183.6	139.2	58.0	177.8	138.5	63.0	171.6	137.3	68.3	165.0	135.4	74.0
	20	204.4	127.7	45.1	199.6	128.3	49.3	194.3	128.3	53.7	188.7	128.0	58.4	182.7	127.1	63.4	176.3	125.7	68.8	169.5	123.8	74.5
	22	216.8	103.1	45.4	211.6	102.8	49.7	206.0	102.2	54.2	200.0	101.3	59.1	193.6	100.0	64.2	186.8	98.4	69.7	179.5	96.3	75.6
28	18	194.2	157.0	44.8	189.6	158.4	48.9	184.7	159.3	53.2	179.4	159.6	57.8	173.7	159.2	62.7	167.7	158.2	67.9	161.3	155.6	73.6
	20	204.7	138.6	45.1	199.8	139.5	49.3	194.6	139.8	53.7	189.0	139.6	58.4	183.0	138.9	63.4	176.6	137.6	68.8	169.7	135.7	74.5
	22	216.3	116.2	45.4	211.1	116.3	49.7	205.6	116.1	54.2	199.6	115.4	59.1	193.2	114.3	64.2	186.4	112.8	69.7	179.1	110.7	75.6
	24	229.4	88.4	45.6	223.9	87.7	50.1	217.9	86.7	54.8	211.5	85.4	59.7	204.7	83.9	65.0	197.4	82.0	70.7	189.7	79.9	76.7
30	19	201.4	167.1	45.0	196.6	168.8	49.1	191.5	169.9	53.5	186.0	170.3	58.2	180.1	170.0	63.2	173.8	168.1	68.5	167.1	161.4	74.2
	21	211.4	149.7	45.3	206.3	150.8	49.5	200.9	151.4	54.0	195.1	151.4	58.8	188.8	150.7	63.9	182.2	149.5	69.3	175.1	147.5	75.1
	23	222.4	128.5	45.5	217.0	129.0	49.9	211.3	129.0	54.5	205.1	128.5	59.4	198.5	127.5	64.6	191.5	126.0	70.2	184.0	124.0	76.1
	25	234.7	102.8	45.7	229.0	102.4	50.2	222.9	101.7	55.0	216.3	100.7	60.0	209.3	99.3	65.4	201.8	97.6	71.1	193.9	95.4	77.1
32	21	213.7	169.3	45.3	208.6	170.9	49.6	203.1	172.0	54.1	197.2	172.3	58.9	190.9	172.0	64.0	184.1	170.8	69.5	177.0	168.9	75.3
	23	223.6	151.0	45.5	218.3	152.1	49.9	212.5	152.6	54.5	206.3	152.5	59.4	199.6	151.9	64.7	192.5	150.5	70.3	185.0	148.5	76.2
	25	234.7	129.0	45.7	229.0	129.4	50.2	222.9	129.3	55.0	216.3	128.8	60.0	209.3	127.8	65.4	201.8	126.2	71.1	193.9	124.1	77.1
	26	240.6	116.3	45.8	234.8	116.3	50.4	228.5	115.9	55.2	221.8	115.1	60.3	214.6	113.9	65.7	206.9	112.2	71.5	198.7	110.1	77.6



Packaged Rooftop Air Conditioners R32

OPA 2110 Performance Data

Cooling Capacity (kW)

- TC = Total Capacity (kW)
- SC = Sensible Capacity (kW)
- PI = Power Input (kW)
- EAT = Entering Air Temperature
- = Nominal Capacity (kW)

Nominal Air Flow: **11 000 l/s**

Note: Capacities are **gross** and do not include allowance for fan motor heat loss.

OPA 2110 Econex @Nominal Capacity (11 000 l/s)

Indoor coil
E.A.T.

Outdoor coil Entering Air Temperature °C DB

D.B. °C	W.B. °C	20			25			30			35			40			45			50		
		TC	SC	PI	TC	SC	PI	TC	SC	PI	TC	SC	PI	TC	SC	PI	TC	SC	PI	TC	SC	PI
20	14	190.9	143.0	49.1	186.0	142.7	53.4	181.0	142.0	58.0	175.8	141.1	62.6	168.7	138.2	68.1	161.4	134.9	73.8	153.0	132.2	74.4
	15	197.9	130.5	49.3	192.9	129.8	53.7	187.6	128.7	58.3	182.1	127.4	63.1	174.6	124.3	68.8	166.8	120.8	74.6	158.0	118.1	75.2
	16	205.3	116.4	49.6	200.2	115.3	54.0	194.7	113.8	58.7	188.8	112.1	63.6	180.8	108.7	69.4	172.5	105.1	75.3	163.3	102.5	76.0
	17	213.2	100.4	49.8	207.9	98.8	54.3	202.2	96.9	59.1	196.0	94.7	64.1	187.6	91.2	70.0	178.8	87.5	76.1	169.1	85.2	76.8
22	16	202.6	144.3	49.5	197.5	144.0	53.9	192.1	143.2	58.6	186.3	142.0	63.4	178.5	138.8	69.2	170.4	135.1	75.1	161.3	132.2	75.7
	17	209.5	131.4	49.7	204.3	130.7	54.2	198.7	129.5	58.9	192.6	127.9	63.9	184.4	124.6	69.7	175.9	120.7	75.8	166.4	118.0	76.5
	18	216.8	117.0	49.9	211.5	115.9	54.4	205.6	114.3	59.3	199.3	112.3	64.3	190.7	108.8	70.3	181.7	104.9	76.4	171.8	102.3	77.2
	19	224.5	100.7	50.1	219.1	99.1	54.7	213.1	97.1	59.6	206.5	94.7	64.8	197.4	91.1	70.9	188.0	87.2	77.1	177.7	84.8	77.9
24	16	202.0	167.9	49.5	197.0	168.3	53.9	191.5	168.0	58.6	185.8	167.2	63.4	178.0	164.1	69.1	170.0	159.2	75.0	160.9	152.1	75.7
	18	214.5	145.6	49.8	209.2	145.3	54.3	203.4	144.4	59.2	197.2	143.0	64.2	188.7	139.5	70.1	179.9	135.5	76.2	170.1	132.5	77.0
	20	228.5	117.3	50.2	223.1	116.2	54.8	217.0	114.5	59.8	210.3	112.5	65.0	201.0	108.7	71.2	191.4	104.7	77.5	180.8	102.0	78.3
	21	236.1	100.8	50.3	230.7	99.2	55.0	224.3	97.1	60.1	217.4	94.7	65.4	207.7	90.9	71.7	197.7	86.8	78.1	186.8	84.5	78.9
26	17	208.5	179.9	49.7	203.4	180.5	54.1	197.7	180.5	58.9	191.7	179.8	63.8	183.6	173.3	69.7	175.1	166.1	75.7	165.7	156.8	76.4
	19	220.2	159.1	50.0	214.9	159.1	54.5	208.9	158.5	59.4	202.5	157.2	64.5	193.7	153.6	70.6	184.5	149.5	76.8	174.4	146.2	77.5
	20	226.6	146.8	50.1	221.2	146.5	54.7	215.1	145.6	59.7	208.4	144.0	64.9	199.2	140.3	71.0	189.7	136.1	77.3	179.3	133.0	78.1
	22	240.5	117.8	50.4	235.0	116.6	55.1	228.6	114.9	60.3	221.5	112.7	65.6	211.7	108.9	72.0	201.5	104.7	78.5	190.3	102.0	79.3
27	18	214.7	181.2	49.8	209.4	181.9	54.4	203.6	181.8	59.2	197.4	181.0	64.2	188.9	177.4	70.1	180.0	169.9	76.2	170.2	161.4	77.0
	19	220.4	171.0	50.0	215.1	171.4	54.6	209.1	171.0	59.5	202.7	169.9	64.5	193.8	166.4	70.6	184.7	162.1	76.8	174.6	158.7	77.5
	20	226.3	159.9	50.1	221.0	160.0	54.7	214.9	159.3	59.7	208.2	157.9	64.9	199.1	154.3	71.0	189.6	150.0	77.3	179.2	146.7	78.1
	22	239.4	133.5	50.4	234.0	132.8	55.1	227.6	131.5	60.2	220.5	129.6	65.5	210.7	125.7	71.9	200.5	121.4	78.4	189.4	118.5	79.2
28	18	215.6	191.7	49.9	210.3	192.7	54.4	204.5	192.8	59.2	198.2	188.1	64.2	189.6	180.8	70.2	180.7	171.9	76.3	170.9	162.1	77.1
	20	226.7	172.0	50.1	221.3	172.4	54.8	215.2	172.0	59.7	208.5	170.8	64.9	199.3	167.1	71.0	189.8	162.8	77.3	179.4	159.3	78.1
	22	238.9	148.0	50.4	233.4	147.7	55.1	227.0	146.7	60.2	220.0	145.1	65.5	210.2	141.2	71.9	200.1	136.8	78.4	189.0	133.7	79.2
	24	252.8	118.3	50.6	247.2	117.2	55.4	240.5	115.4	60.7	233.1	113.2	66.1	222.7	109.2	72.7	206.4	104.4	76.2	200.1	102.3	80.3
30	19	223.1	203.4	50.1	217.8	204.7	54.6	211.8	201.3	59.6	205.2	196.4	64.7	196.3	187.4	70.8	186.9	178.1	77.0	176.7	167.8	77.8
	21	233.7	184.6	50.3	228.2	185.4	55.0	222.0	185.3	60.0	215.1	184.3	65.2	205.6	180.5	71.5	195.7	175.9	77.9	184.9	172.2	78.7
	23	245.3	162.0	50.5	239.8	162.2	55.3	233.3	161.5	60.4	226.0	160.0	65.8	216.0	156.1	72.3	205.5	151.5	78.9	194.1	148.1	79.7
	25	258.3	134.5	50.7	252.7	133.9	55.5	246.0	132.6	60.8	238.4	130.5	66.3	227.8	126.5	73.0	211.1	121.1	76.6	204.6	119.2	80.7
32	21	236.1	206.4	50.3	230.7	207.9	55.0	224.3	208.2	60.1	217.4	206.1	65.4	207.7	198.1	71.7	197.7	188.9	78.1	186.8	177.9	78.9
	23	246.6	186.9	50.5	241.1	187.8	55.3	234.6	187.7	60.5	227.3	186.6	65.9	217.2	182.7	72.3	206.7	177.9	79.0	195.2	174.1	79.8
	25	258.3	163.4	50.7	252.7	163.7	55.5	246.0	163.0	60.8	238.4	161.5	66.3	227.8	157.5	73.0	211.1	151.1	76.6	204.6	149.5	80.7
	26	264.6	149.9	50.7	259.0	149.8	55.6	252.2	148.8	61.0	244.4	147.0	66.6	233.6	143.0	73.3	216.5	137.1	77.0	209.9	135.3	81.1



Packaged Rooftop Air Conditioners R32

OPA 2110 Performance Data

Cooling Capacity (kW)

- TC = Total Capacity (kW)
- SC = Sensible Capacity (kW)
- PI = Power Input (kW)
- EAT = Entering Air Temperature
- = Nominal Capacity (kW)

Nominal Air Flow: **11 000 l/s**

Note: Capacities are **gross** and do not include allowance for fan motor heat loss.

OPA 2110 Econex Pro @Nominal Capacity (11 000 l/s)

Indoor coil
E.A.T.

Outdoor coil Entering Air Temperature °C DB

D.B. °C	W.B. °C	20			25			30			35			40			45			50		
		TC	SC	PI	TC	SC	PI	TC	SC	PI	TC	SC	PI	TC	SC	PI	TC	SC	PI	TC	SC	PI
20	14	199.4	143.6	50.7	194.6	143.7	55.2	189.5	143.4	59.9	184.0	142.6	65.0	178.2	141.3	70.5	172.0	139.5	76.4	139.8	125.9	63.6
	15	207.0	130.4	51.0	202.0	130.1	55.5	196.7	129.4	60.4	190.9	128.2	65.6	184.8	126.6	71.2	178.3	124.6	77.2	144.8	113.5	64.1
	16	215.0	115.5	51.3	209.8	114.7	56.0	204.2	113.6	60.9	198.2	112.0	66.2	191.9	110.2	71.9	185.1	107.9	77.9	150.1	99.6	64.7
	17	223.5	98.6	51.6	218.1	97.2	56.4	212.3	95.6	61.4	206.0	93.7	66.8	199.4	91.5	72.5	192.3	89.0	78.7	155.7	84.0	65.2
22	16	212.0	144.8	51.2	206.9	144.8	55.8	201.4	144.4	60.7	195.6	143.5	66.0	189.3	142.0	71.6	182.6	140.0	77.6	148.1	126.7	64.5
	17	219.5	131.2	51.5	214.2	130.7	56.2	208.5	129.9	61.2	202.4	128.6	66.5	195.9	126.9	72.2	188.9	124.7	78.3	153.1	114.0	65.0
	18	227.4	115.9	51.8	221.9	115.0	56.5	216.0	113.7	61.6	209.6	112.1	67.1	202.8	110.1	72.9	195.5	107.7	79.0	158.3	99.9	65.5
	19	235.9	98.6	52.0	230.1	97.1	56.9	223.9	95.3	62.1	217.3	93.3	67.6	210.2	91.0	73.5	202.6	88.5	79.8	163.8	83.9	66.0
24	16	211.4	169.5	51.2	206.3	170.3	55.8	200.8	170.4	60.7	195.0	170.0	65.9	188.7	168.9	71.6	182.1	167.1	77.6	147.7	141.0	64.4
	18	224.9	146.0	51.7	219.5	145.9	56.4	213.6	145.4	61.5	207.3	144.3	66.9	200.6	142.8	72.7	193.4	140.6	78.8	156.6	127.6	65.3
	20	240.3	116.1	52.2	234.4	115.0	57.1	228.0	113.6	62.3	221.3	111.8	67.9	214.0	109.7	73.8	206.3	107.2	80.2	166.7	99.9	66.3
	21	248.6	98.5	52.4	242.4	96.8	57.4	235.9	95.0	62.8	228.8	92.8	68.4	221.3	90.4	74.5	213.3	87.8	80.9	172.2	83.9	66.8
26	17	218.5	182.0	51.5	213.2	183.0	56.1	207.5	183.4	61.1	201.4	183.1	66.4	194.9	182.1	72.1	188.0	180.3	78.2	152.4	145.7	64.9
	19	231.2	160.1	51.9	225.5	160.3	56.7	219.5	160.0	61.8	213.0	159.2	67.3	206.1	157.7	73.1	198.7	155.6	79.4	160.8	140.4	65.7
	20	238.1	147.1	52.1	232.3	146.9	57.0	226.0	146.2	62.2	219.3	145.1	67.8	212.2	143.4	73.7	204.5	141.1	80.0	165.3	128.4	66.2
	22	253.4	116.2	52.6	247.1	115.0	57.6	240.4	113.5	63.0	233.2	111.6	68.7	225.5	109.4	74.8	217.4	106.9	81.3	175.3	100.1	67.1
27	18	225.2	183.4	51.7	219.7	184.3	56.4	213.8	184.7	61.5	207.5	184.3	66.9	200.8	183.2	72.7	193.6	181.4	78.8	156.8	150.1	65.3
	19	231.4	172.6	51.9	225.8	173.2	56.7	219.7	173.2	61.8	213.2	172.6	67.3	206.3	171.3	73.2	198.9	169.3	79.4	160.9	151.9	65.7
	20	237.9	160.8	52.1	232.1	161.0	57.0	225.8	160.7	62.2	219.1	159.8	67.7	212.0	158.3	73.7	204.3	156.1	80.0	165.2	141.0	66.1
	22	252.2	132.8	52.5	245.9	132.1	57.6	239.3	131.0	62.9	232.1	129.4	68.6	224.5	127.4	74.7	216.4	125.0	81.2	174.6	115.3	67.0
28	18	226.1	194.4	51.7	220.6	195.6	56.5	214.7	196.2	61.5	208.4	196.0	67.0	201.6	194.9	72.7	194.4	187.7	78.9	157.4	150.7	65.4
	20	238.2	173.5	52.1	232.4	174.0	57.0	226.1	174.0	62.2	219.4	173.3	67.8	212.3	172.0	73.7	204.6	169.9	80.0	165.4	152.7	66.2
	22	251.6	148.1	52.5	245.4	147.8	57.6	238.7	147.0	62.9	231.6	145.7	68.6	224.0	144.0	74.7	215.9	141.6	81.1	174.2	129.2	67.0
	24	266.7	116.4	52.9	260.0	115.1	58.1	252.9	113.5	63.6	245.3	111.6	69.5	237.2	109.3	75.7	228.6	106.6	82.3	184.1	100.4	67.8
30	19	234.4	206.5	52.0	228.7	208.0	56.8	222.5	208.8	62.0	215.9	208.8	67.5	208.9	202.2	73.4	201.4	194.7	79.7	162.9	156.2	65.9
	21	245.9	186.7	52.4	239.8	187.5	57.3	233.3	187.7	62.6	226.4	187.2	68.3	219.0	186.0	74.3	211.1	183.9	80.7	170.4	163.7	66.6
	23	258.6	162.7	52.7	252.2	162.7	57.8	245.3	162.2	63.3	237.9	161.2	69.0	230.1	159.5	75.2	221.7	157.2	81.7	178.8	142.6	67.4
	25	272.7	133.4	53.1	265.9	132.5	58.3	258.6	131.3	63.9	250.8	129.6	69.9	242.5	127.5	76.1	233.6	124.9	82.8	188.1	115.9	68.2
32	21	248.6	209.6	52.4	242.4	211.1	57.4	235.9	211.8	62.8	228.8	211.6	68.4	221.3	210.7	74.5	213.3	206.6	80.9	172.2	165.5	66.8
	23	260.0	188.9	52.7	253.6	189.7	57.9	246.6	189.8	63.3	239.3	189.2	69.1	231.4	187.8	75.3	223.0	185.7	81.8	179.7	166.6	67.5
	25	272.7	163.9	53.1	265.9	163.9	58.3	258.6	163.3	63.9	250.8	162.1	69.9	242.5	160.4	76.1	233.6	158.0	82.8	188.1	143.7	68.2
	26	279.5	149.5	53.2	272.6	149.0	58.6	265.1	148.0	64.2	257.1	146.6	70.2	248.5	144.6	76.6	239.4	142.1	83.4	192.6	130.6	68.5



Packaged Rooftop Air Conditioners R32

OPA 1410 Performance Data

Heating Capacity (kW)

- G = Gross Capacity kW, based on nominal air flow.
- N = Net Heating Capacity kW allowing for average defrost.
- PI = Power Input (kW)
- = Nominal Capacity (kW).

OPA 1410 Econex at Nominal Capacity (8 100 l/s)

Air on				Outdoor coil entering air temperature °C DB																							
D.B. °C	- 10			- 5			0			5			7			10			15			20			25		
	G	N	PI	G	N	PI	G	N	PI	G	N	PI	G	N	PI	G	N	PI	G	N	PI	G	N	PI	G	N	PI
10	91.6	80.3	32.1	106.9	93.6	34.3	122.1	108.0	36.6	137.4	136.7	37.3	143.5	143.5	38.1	152.7	152.7	39.4	168.0	168.0	41.8	183.3	183.3	44.4	198.5	198.5	47.4
15	91.8	80.5	32.4	107.1	93.8	34.8	122.4	108.2	37.3	137.7	136.9	38.1	143.8	143.8	39.0	152.9	152.9	40.3	168.2	168.2	42.8	183.5	183.5	45.6	198.8	198.8	48.7
20	90.3	79.2	32.7	105.5	92.6	35.3	120.8	106.9	37.9	136.1	135.4	38.7	142.1	142.1	39.6	151.4	151.4	41.1	166.7	166.7	43.7	181.9	181.9	46.6	197.2	197.2	49.8
25	86.9	76.5	32.8	102.2	89.9	35.6	117.4	104.0	38.3	132.7	132.2	39.1	138.8	138.8	39.9	148.0	148.0	41.6	163.3	163.3	44.3	178.6	178.6	47.2	193.8	193.8	50.5

OPA 1410 Econex Pro at Nominal Capacity (8 100 l/s)

Air on				Outdoor coil entering air temperature °C DB																							
D.B. °C	- 10			- 5			0			5			7			10			15			20			25		
	G	N	PI	G	N	PI	G	N	PI	G	N	PI	G	N	PI	G	N	PI	G	N	PI	G	N	PI	G	N	PI
10	93.3	81.7	34.9	108.8	95.4	37.4	124.4	109.2	40.0	140.0	136.9	40.9	146.2	146.2	41.8	155.5	155.5	43.3	171.1	171.1	45.9	186.6	186.6	48.7	202.2	202.2	51.7
15	93.5	81.9	35.4	109.1	95.6	38.0	124.6	109.4	40.7	140.2	137.1	41.6	146.4	146.4	42.6	155.8	155.8	44.1	171.3	171.3	46.7	186.9	186.9	49.6	202.4	202.4	52.7
20	91.9	80.7	35.8	107.5	94.3	38.5	123.0	108.2	41.3	138.6	135.9	42.2	144.8	144.8	43.2	154.2	154.2	44.7	169.7	169.7	47.4	185.3	185.3	50.4	200.8	200.8	53.6
25	88.5	77.9	36.0	104.0	91.6	38.8	119.6	105.4	41.7	135.2	133.1	42.6	141.4	141.4	43.6	150.7	150.7	45.2	166.3	166.3	48.0	181.8	181.8	51.0	197.4	197.4	54.3

Indoor Air Flow Correction Factors @ nominal conditions

Cooling	Indoor Air Flow (%)			
	-20	-10	Rated	+10
Total Capacity	0.950	0.975	1.000	1.025
Sensible Capacity	0.890	0.950	1.000	1.050



Packaged Rooftop Air Conditioners R32

OPA 1710 Performance Data

Heating Capacity (kW)

- G** = Gross Capacity kW, based on nominal air flow.
- N** = Net Heating Capacity kW allowing for average defrost.
- PI** = Power Input (kW)
- = Nominal Capacity (kW).

OPA 1710 Econex at Nominal Capacity (8 200 l/s)

Air on D.B. °C	Outdoor coil entering air temperature °C DB																													
	- 10			- 5			0			5			7			10			15			20			25					
	G	N	PI	G	N	PI	G	N	PI	G	N	PI	G	N	PI	G	N	PI	G	N	PI	G	N	PI	G	N	PI	G	N	PI
10	110.0	96.4	41.1	128.3	112.5	44.0	146.7	128.8	47.1	165.0	161.5	48.0	172.4	172.4	49.1	183.4	183.4	50.9	201.7	201.7	53.9	220.1	220.1	57.3	238.4	238.4	60.9			
15	110.3	96.6	41.7	128.6	112.7	44.7	147.0	129.0	47.9	165.3	161.7	48.9	172.7	172.7	50.0	183.7	183.7	51.8	202.0	202.0	55.0	220.4	220.4	58.5	238.7	238.7	62.2			
20	108.4	95.1	42.1	126.7	111.2	45.3	145.1	127.5	48.5	163.4	160.2	49.6	170.8	170.8	50.7	181.8	181.8	52.6	200.1	200.1	55.9	218.5	218.5	59.4	236.8	236.8	63.3			
25	104.3	91.9	42.3	122.7	108.0	45.6	141.0	124.3	48.9	159.4	157.0	50.0	166.7	166.7	51.2	177.7	177.7	53.1	196.1	196.1	56.5	214.4	214.4	60.2	232.8	232.8	64.1			

OPA 1710 Econex Pro at Nominal Capacity (8 200 l/s)

Air on D.B. °C	Outdoor coil entering air temperature °C DB																													
	- 10			- 5			0			5			7			10			15			20			25					
	G	N	PI	G	N	PI	G	N	PI	G	N	PI	G	N	PI	G	N	PI	G	N	PI	G	N	PI	G	N	PI	G	N	PI
10	118.2	103.5	45.8	137.9	120.8	49.1	157.6	138.4	52.6	177.3	173.5	53.7	185.2	185.2	54.9	197.0	197.0	56.8	216.7	216.7	60.3	236.4	236.4	63.9	256.2	256.2	67.8			
15	118.5	103.8	46.7	138.2	121.1	50.0	157.9	138.6	53.6	177.6	173.7	54.7	185.5	185.5	56.0	197.3	197.3	58.0	217.0	217.0	61.4	236.8	236.8	65.1	256.5	256.5	69.1			
20	116.4	102.2	47.4	136.2	119.5	50.9	155.9	137.0	54.5	175.6	172.1	55.6	183.5	183.5	56.9	195.3	195.3	59.0	215.0	215.0	62.5	234.7	234.7	66.3	254.4	254.4	70.4			
25	112.1	98.7	48.0	131.8	116.0	51.5	151.5	133.6	55.3	171.2	168.7	56.4	179.1	179.1	57.8	190.9	190.9	59.8	210.6	210.6	63.5	230.4	230.4	67.4	250.1	250.1	71.5			



Packaged Rooftop Air Conditioners R32

OPA 2110 Performance Data

Heating Capacity (kW)

- G** = Gross Capacity kW, based on nominal air flow.
- N** = Net Heating Capacity kW allowing for average defrost.
- PI** = Power Input (kW)
- = Nominal Capacity (kW).

OPA 2110 Econex at Nominal Capacity (11 000 l/s)

Air on		Outdoor coil entering air temperature °C DB																													
		- 10			- 5			0			5			7			10			15			20			25					
D.B.	°C	G	N	PI	G	N	PI	G	N	PI	G	N	PI	G	N	PI	G	N	PI	G	N	PI	G	N	PI	G	N	PI	G	N	PI
10		125.5	109.9	45.2	146.4	128.3	48.5	167.3	147.3	51.7	188.3	185.3	52.7	196.6	196.6	53.8	209.2	209.2	55.6	230.1	230.1	58.7	251.0	251.0	62.2	272.0	272.0	66.0			
15		125.8	110.2	45.7	146.7	128.5	49.0	167.7	147.6	52.2	188.6	185.6	53.3	197.0	197.0	54.4	209.5	209.5	56.2	230.4	230.4	59.4	251.4	251.4	62.9	272.3	272.3	66.8			
20		123.6	108.3	46.0	144.6	126.9	49.5	165.5	145.8	53.0	186.4	183.8	54.0	194.8	194.8	55.2	207.4	207.4	57.1	228.3	228.3	60.5	249.2	249.2	64.1	270.2	270.2	68.2			
25		119.0	104.8	46.2	139.9	123.2	49.9	160.9	142.1	53.5	181.8	179.8	54.6	190.2	190.2	55.8	202.7	202.7	57.8	223.7	223.7	61.2	244.6	244.6	65.0	265.5	265.5	69.2			

OPA 2110 Econex Pro at Nominal Capacity (11 000 l/s)

Air on		Outdoor coil entering air temperature °C DB																													
		- 10			- 5			0			5			7			10			15			20			25					
D.B.	°C	G	N	PI	G	N	PI	G	N	PI	G	N	PI	G	N	PI	G	N	PI	G	N	PI	G	N	PI	G	N	PI	G	N	PI
10		130.8	114.6	46.7	152.7	133.8	49.9	174.5	153.2	53.3	196.3	192.0	54.3	205.0	205.0	55.5	218.1	218.1	57.4	240.0	240.0	60.8	261.8	261.8	64.4	283.6	283.6	68.2			
15		131.2	114.9	47.5	153.0	134.0	50.8	174.8	153.5	54.2	196.7	192.3	55.3	205.4	205.4	56.5	218.5	218.5	58.5	240.3	240.3	61.9	262.1	262.1	65.5	284.0	284.0	69.4			
20		128.9	113.1	48.1	150.8	132.3	51.5	172.6	151.7	55.0	194.4	190.6	56.1	203.0	203.0	57.4	216.2	216.2	59.4	238.1	238.1	62.9	259.9	259.9	66.6	281.7	281.7	70.6			
25		124.1	109.3	48.5	145.9	128.5	52.0	167.8	147.9	55.6	189.6	186.7	56.8	198.3	198.3	58.1	211.4	211.4	60.1	233.2	233.2	63.7	255.1	255.1	67.5	276.9	276.9	71.6			



Packaged Rooftop Air Conditioners R32

Performance Data

Air Handling

Airflows are for a dry coil. Refer Air Flow Selection (p.4) for further information.
Air flows given are for OPA units without filters installed. No allowance for Reheat coil option (Econex Pro). Amps are 'per phase'

OPA 1410

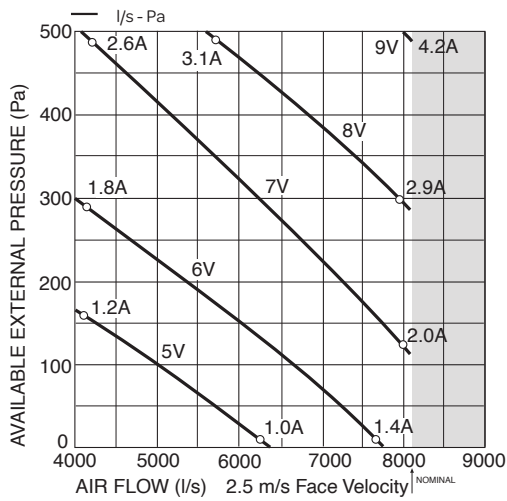

OPA 1710

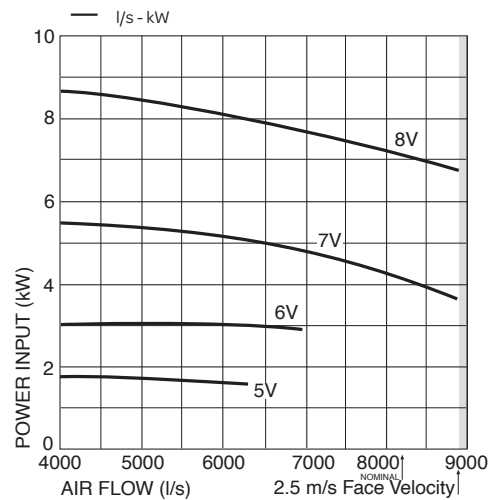
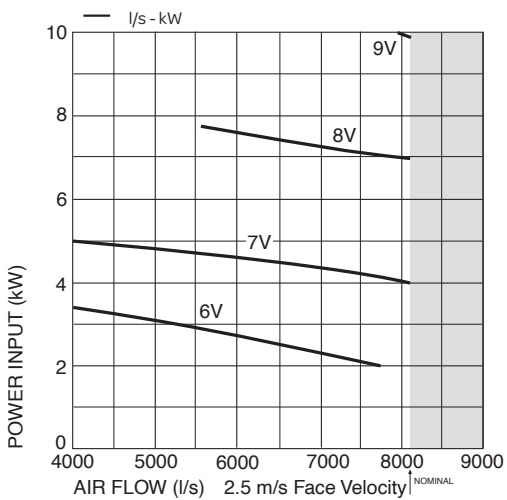
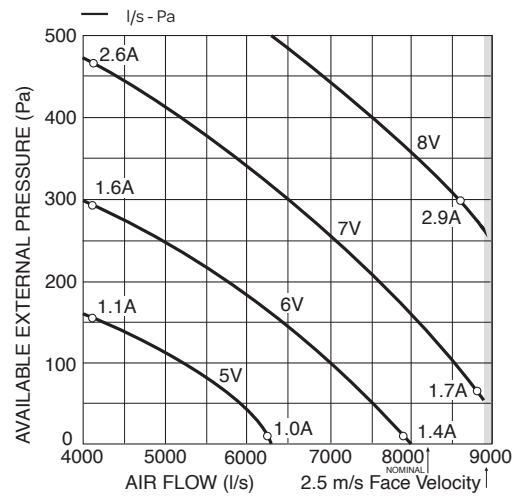

Refer page 19 for Filter Pressure Drop graph



Packaged Rooftop Air Conditioners R32

Performance Data

Air Handling

Airflows are for a dry coil. Refer Air Flow Selection (p.4) for further information.
 Air flows given are for OPA units without filters installed. No allowance for Reheat coil option (Econex Pro).

OPA 2110

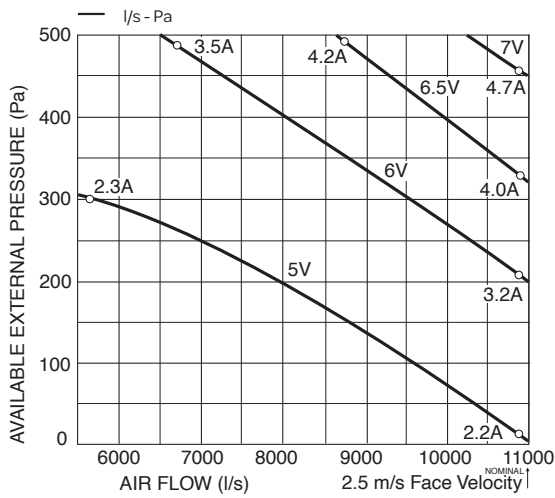

Filter Pressure Drop (optional Filters)

EU4/G4 rated filter media (50mm)

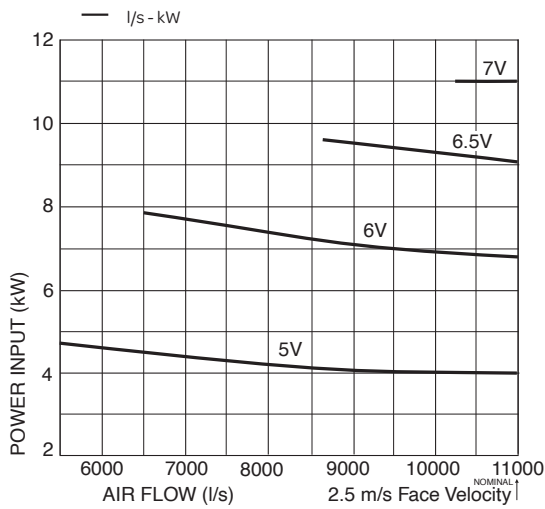
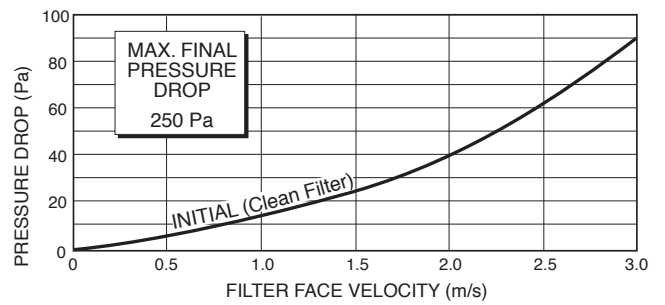



Packaged Rooftop Air Conditioners R32

Performance Data

Sound Levels – Indoor

Test Conditions: EN 12102-1:2017.
Diffuse field method in a reverberant room.
Measured in decibels re 1 picowatt.

Sound Power Levels (SWL) – Supply Air Outlet

Models	Fan Speed	Static (Pa)	SWL dB(A)	Octave Band Frequency Hz					
				125	250	500	1k	2k	4k
OPA 1410 Econex	4 V	75	71.0	71.2	70.0	68.6	67.1	62.0	53.9
	7.5 V *	160	85.7	88.7	84.4	83.0	81.7	76.8	68.6
OPA 1710 Econex	4 V	43	69.4	69.1	67.9	66.5	65.6	61.0	52.9
	7.5 V *	185	85.3	88.3	83.8	82.4	81.3	76.6	68.4
OPA 2110 Econex	4 V	70	80.0	64.7	70.3	77.5	80.0	73.0	67.6
	6.5 V *	180	91.0	74.5	85.0	90.3	89.7	86.3	80.9

* Note: Indoor Air fan running at nominal speed

Sound Pressure Levels (SPL) Within A Room

Deduct the room absorption effect below from the Sound Power Levels (SWL) above to obtain Sound Pressure Levels within a room.
Note: Occupant at least 1.5 m from sound source.

Room type	Octave Band Frequency Hz					
	125	250	500	1k	2k	4k
Soft	4	8	11	11	11	11
Medium	3	7	8	9	9	9
Hard	0	1	3	4	4	5



Packaged Rooftop Air Conditioners R32

Performance Data

Sound Levels – Outdoor

Sound Power Levels (SWL) – Radiated

Measured in decibels re 1 picowatt

Models	Fan Speed	SWL dB(A)	Octave Band Frequency Hz					
			125	250	500	1K	2K	4K
OPA 1410 Econex	2.2V	57.8	59.7	49.7	53.4	54.7	49.9	44.2
	8V*	76.1	74.9	67.6	71.9	72.6	68.4	64.6
	10V	80.7	78.6	71.9	76.4	77.0	73.1	70.0
OPA 1710 Econex	2.2V	62.8	59.7	58.8	59.3	58.4	56.8	46.8
	7V*	92.0	91.1	91.4	87.7	88.2	83.9	77.9
	10V	98.6	96.4	97.8	93.0	95.0	91.2	85.1
OPA 2110 Econex	2.2V	63.7	58.3	57.4	58.7	58.9	58.9	47.6
	5.5V*	88.5	87.6	87.9	84.2	84.7	80.4	74.4
	10V	97.9	95.9	97.1	92.4	94.3	90.4	84.4

* Note: Outdoor fans running at nominal speed

Sound Pressure Levels (SPL)

Models	Fan Speed	SPL @ 3 m dB(A)	Octave Band Frequency Hz					
			125	250	500	1K	2K	4K
OPA 1410 Econex	2.2V	41.8	43.7	33.7	37.4	38.7	33.9	28.2
	8V*	60.1	58.9	51.6	55.9	56.6	52.4	48.6
	10V	64.7	62.6	55.9	60.4	61.0	57.1	54.0
OPA 1710 Econex	2.2V	46.8	43.7	42.8	43.3	42.4	40.8	30.8
	7V*	76.0	75.1	75.4	71.7	72.2	67.9	61.9
	10V	82.6	80.4	81.8	77.0	79.0	75.2	69.1
OPA 2110 Econex	2.2V	47.7	42.3	41.4	42.7	42.9	42.9	31.6
	5.5V*	72.5	71.6	71.9	68.2	68.7	64.4	58.4
	10V	81.9	79.9	81.1	76.4	78.3	74.4	68.4

Sound Pressure Level (SPL) in decibels re 20 µPa



Packaged Rooftop Air Conditioners R32

Performance Data

Sound Levels – Indoor

Test Conditions: EN 12102-1:2017.
Diffuse field method in a reverberant room.
Measured in decibels re 1 picowatt.

Sound Power Levels (SWL) – Supply Air Outlet

Models	Fan Speed	Static (Pa)	SWL dB(A)	Octave Band Frequency Hz					
				125	250	500	1k	2k	4k
OPA 1410 Econex Pro	4 V	75	71.0	71.2	70.0	68.6	67.1	62.0	53.9
	7.5 V *	160	85.7	88.7	84.4	83.0	81.7	76.8	68.6
OPA 1710 Econex Pro	4 V	43	69.4	69.1	67.9	66.5	65.6	61	52.9
	7.5 V *	185	85.3	88.3	83.8	82.4	81.3	76.6	68.4
OPA 2110 Econex Pro	4V	70	80.0	64.7	70.3	77.5	80.0	73.0	67.6
	6.5 V *	180	91.0	74.5	85.0	90.3	89.7	86.3	80.9

* Note: Indoor Air fan running at nominal speed

Sound Pressure Levels (SPL) Within A Room

Deduct the room absorption effect below from the Sound Power Levels (SWL) above to obtain Sound Pressure Levels within a room.
Note: Occupant at least 1.5 m from sound source.

Room type	Octave Band Frequency Hz					
	125	250	500	1k	2k	4k
Soft	4	8	11	11	11	11
Medium	3	7	8	9	9	9
Hard	0	1	3	4	4	5



Packaged Rooftop Air Conditioners R32

Performance Data

Sound Levels – Outdoor

Sound Power Levels (SWL) – Radiated

Measured in decibels re 1 picowatt

Models	Fan Speed	SWL dB(A)	Octave Band Frequency Hz					
			125	250	500	1K	2K	4K
OPA 1410 Econex Pro	2.2V	62.2	63.8	58.9	55.1	59.8	53.8	46.9
	8V*	81.3	79.8	77.7	74.6	78.4	73.4	69.4
	10V	83.8	81.8	80.2	77.1	80.8	76	72.4
OPA 1710 Econex Pro	2.2V	62.8	59.7	58.8	59.3	58.4	56.8	46.8
	7V*	92.0	91.1	91.4	87.7	88.2	83.9	77.9
	10V	98.6	96.4	97.8	93	95	91.2	85.1
OPA 2110 Econex Pro	2.2V	63.7	58.3	57.4	58.7	58.9	58.9	47.6
	5.5V*	88.5	87.6	87.9	84.2	84.7	80.4	74.4
	10V	97.9	95.9	97.1	92.4	94.3	90.4	84.4

* Note: Outdoor fans running at nominal speed

Sound Pressure Levels (SPL)

Models	Fan Speed	SPL @ 3 m dB(A)	Sound Pressure Levels (SPL) dB					
			125	250	500	1K	2K	4K
OPA 1410 Econex Pro	2.2V	46.2	47.8	42.9	39.1	43.8	37.8	30.9
	8V*	65.3	63.8	61.7	58.6	62.4	57.4	53.4
	10V	67.8	65.8	64.2	61.1	64.8	60.0	56.4
OPA 1710 Econex Pro	2.2V	46.8	43.7	42.8	43.3	42.4	40.8	30.8
	7V*	76.0	75.1	75.4	71.7	72.2	67.9	61.9
	10V	82.6	80.4	81.8	77	79	75.2	69.1
OPA 2110 Econex Pro	2.2V	47.7	42.3	41.4	42.7	42.9	42.9	31.6
	5.5V*	72.5	71.6	71.9	68.2	68.7	64.4	58.4
	10V	81.9	79.9	81.1	76.4	78.3	74.4	68.4

Sound Pressure Level (SPL) in decibels re 20 µPa



Packaged Rooftop Air Conditioners R32

Dimensions (mm)

OPA 1410RLTMB#FPQ(D)(-Z) Horizontal Supply

	POINT LOADS (kg)					
	U	V	W	X	Y	Z
Standard Hand	411	339	267	327	349	371
c/w Economiser	423	360	297	339	358	377

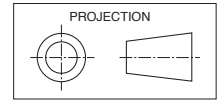

Not to Scale

Multiple units side-by-side:
Allow a minimum of 2m between coil faces.

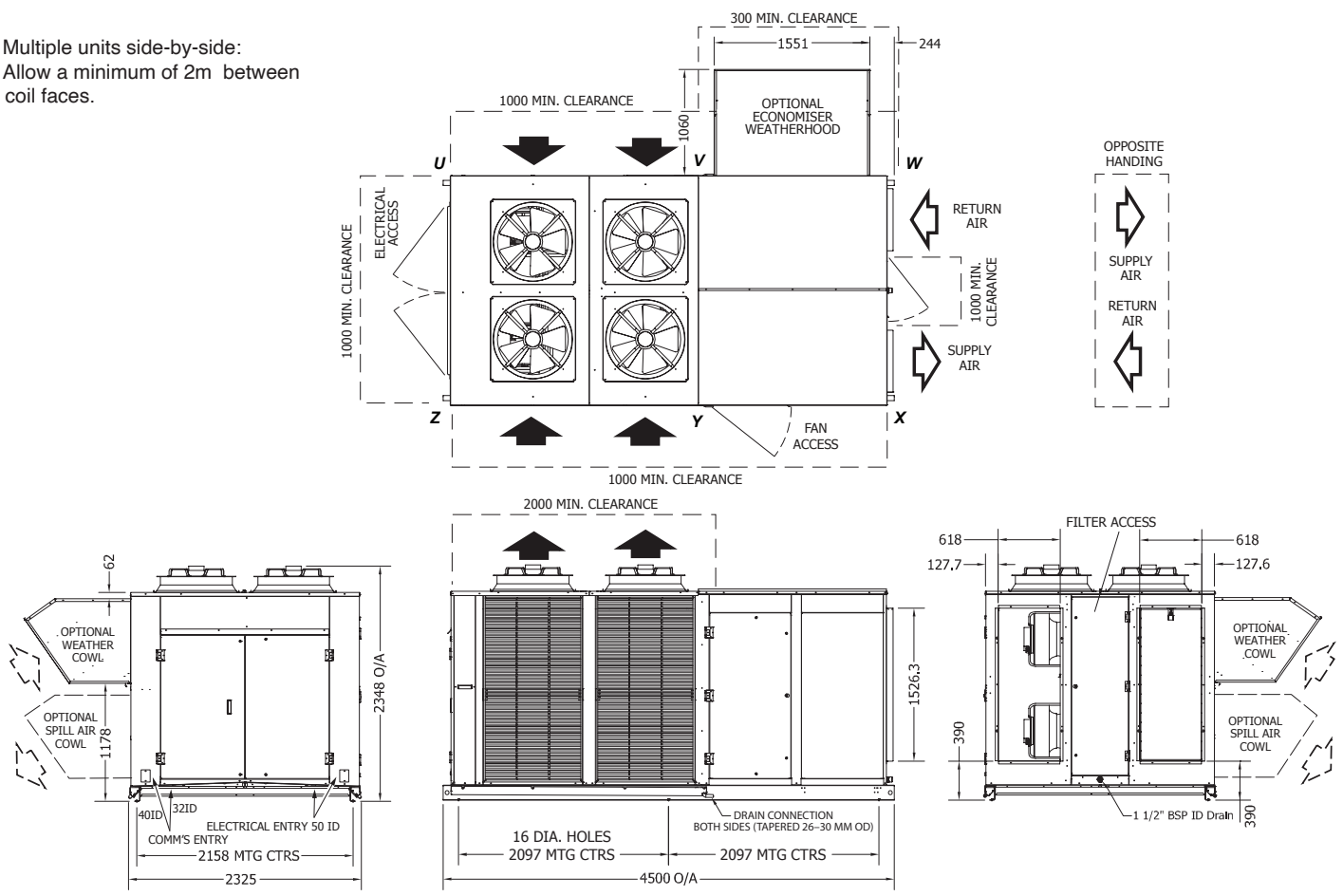

Materials and specifications are subject to change without notice due to the manufacturer's ongoing research and development programme.



Packaged Rooftop Air Conditioners R32

Dimensions (mm)

OPA 1410RLTMB#FPQ(D)(-Z) Supply/Return Air Options

Standard and Opposite Hand configurations available.

Contact Temperzone for other options.
(Note: Economiser cowl is not available fitted to end or top of unit).

Upward Supply & Return Air versions

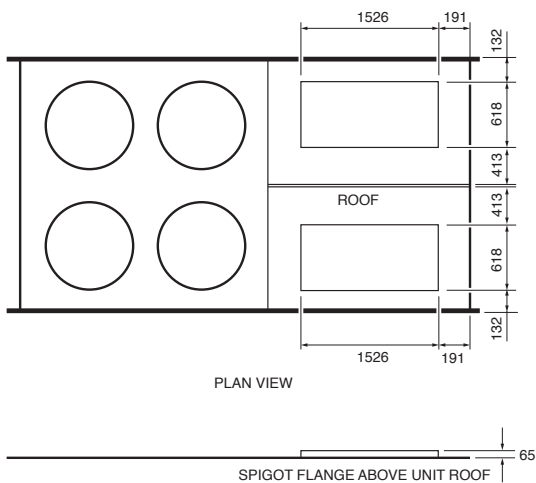

Downward Supply & Return Air versions

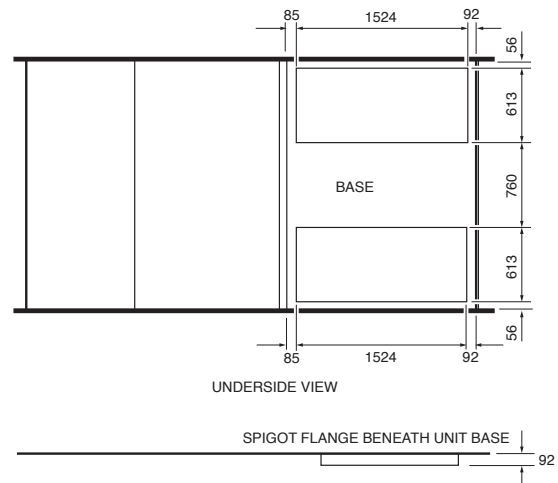

Materials and specifications are subject to change without notice due to the manufacturer's ongoing research and development programme.



Packaged Rooftop Air Conditioners R32

Dimensions (mm)

OPA 1710RLTMB#FPQ(D)(-Z) Horizontal Supply

	POINT LOADS (kg)					
	U	V	W	X	Y	Z
Standard Hand	408	362	317	371	392	413
c/w Economiser	420	383	347	383	401	419

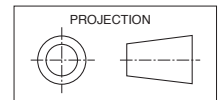

Not to Scale

Multiple units side-by-side:
Allow a minimum of 2m between
coil faces.

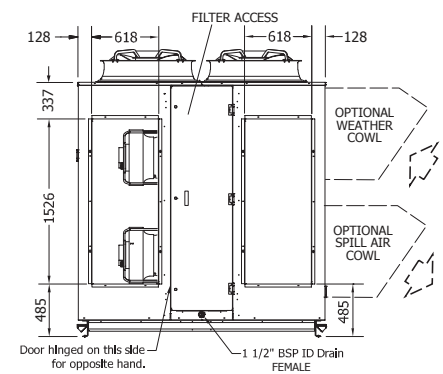
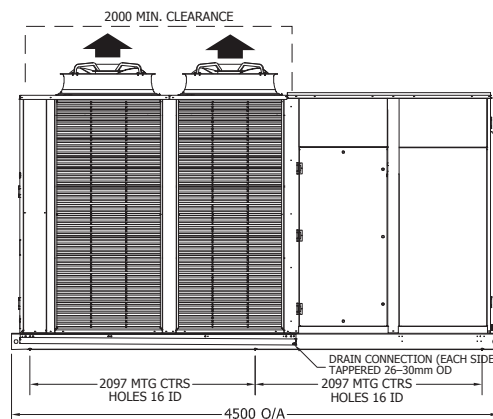
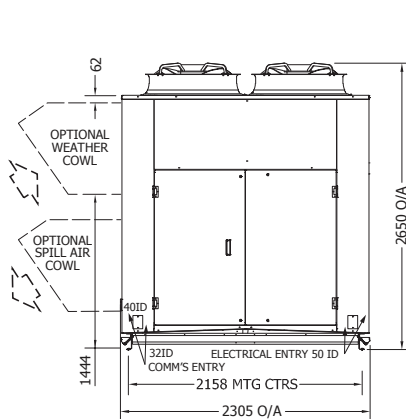
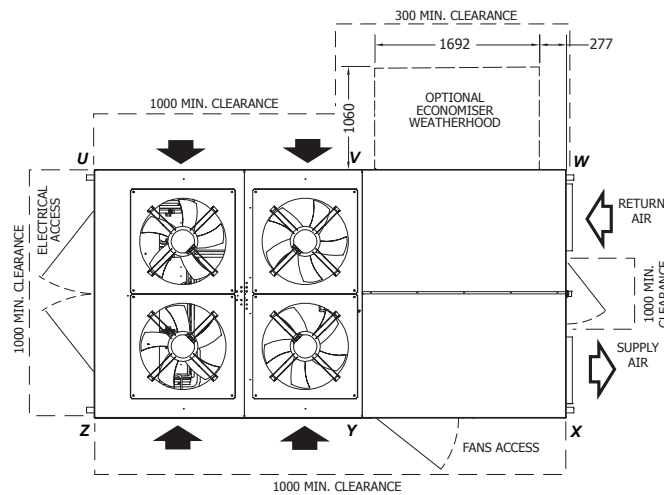



Packaged Rooftop Air Conditioners R32

Dimensions (mm)

OPA 1710RLTMB#FPQ(D)(-Z) Supply/Return Air Options

Standard and Opposite Hand configurations available.

Contact Temperzone for other options.
(Note: Economiser cowl is not available fitted to end or top of unit).

Upward Supply & Return Air versions

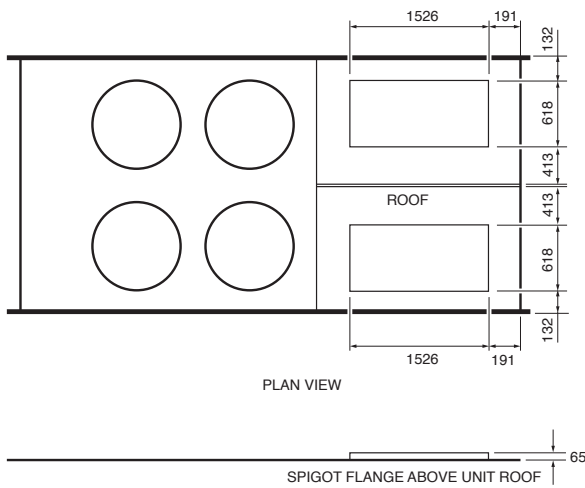

Downward Supply & Return Air versions

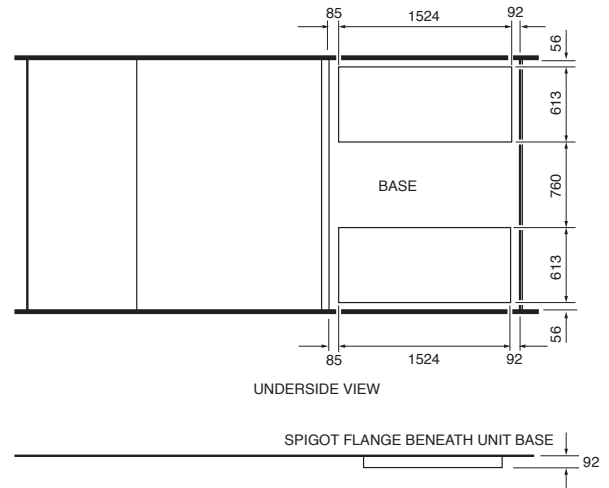

Materials and specifications are subject to change without notice due to the manufacturer's ongoing research and development programme.



Packaged Rooftop Air Conditioners R32

Dimensions (mm)

OPA 2110RLTMB#FPQ(D)(-Z) Horizontal Supply

	POINT LOADS (kg)					
	U	V	W	X	Y	Z
Standard Hand	505	412	318	425	447	470
c/w Economiser	517	433	348	437	456	476

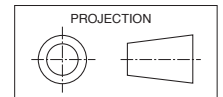

Not to Scale

Multiple units side-by-side:
Allow a minimum of 2m between coil faces.

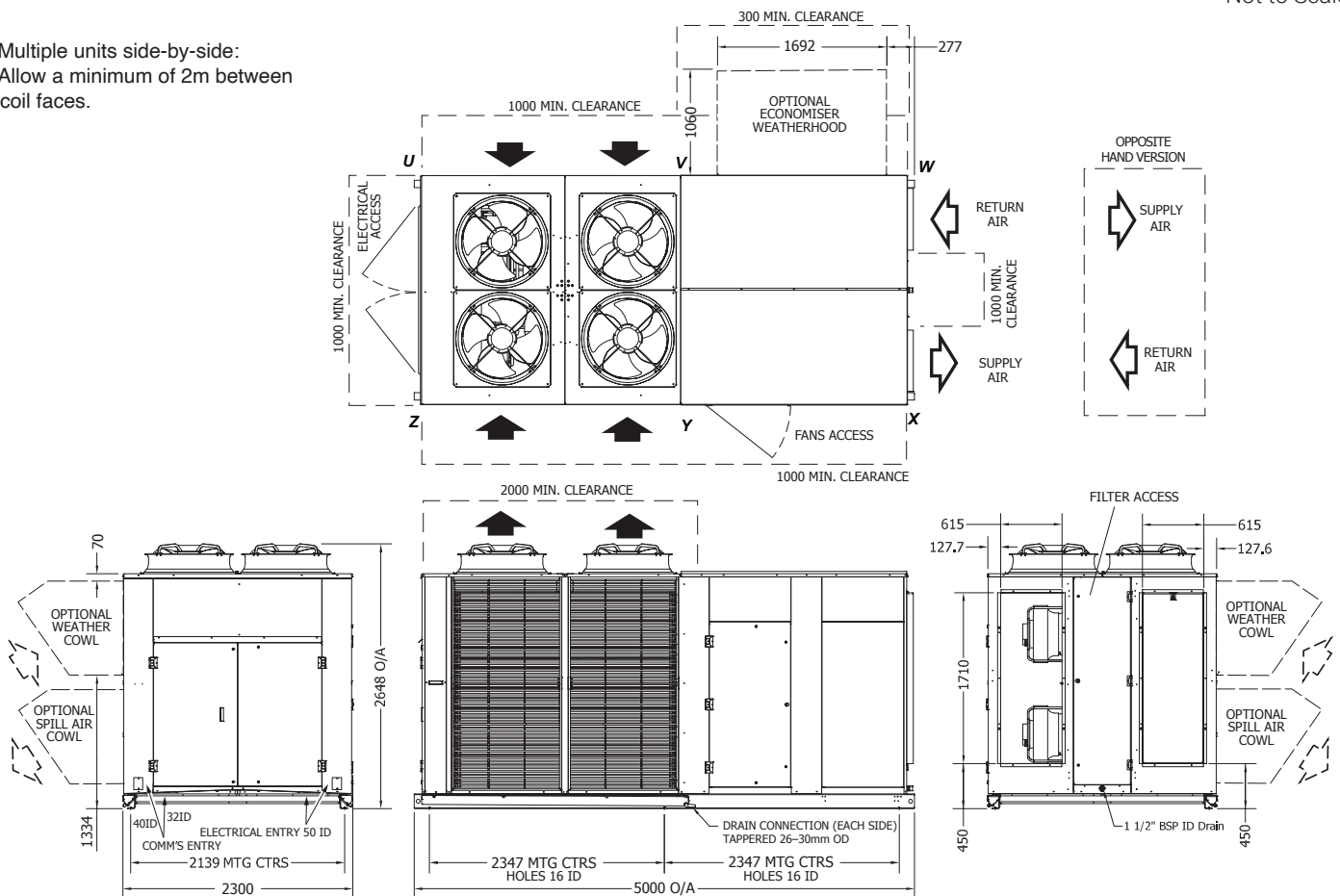



Packaged Rooftop Air Conditioners R32

Dimensions (mm)

OPA 2110RLTMB#FPQ(D)(-Z) Supply/Return Air Options

Standard and Opposite Hand configurations available.

Contact Temperzone for other options.
(Note: Economiser cowl is not available fitted to end or top of unit).

Upward Supply & Return Air versions

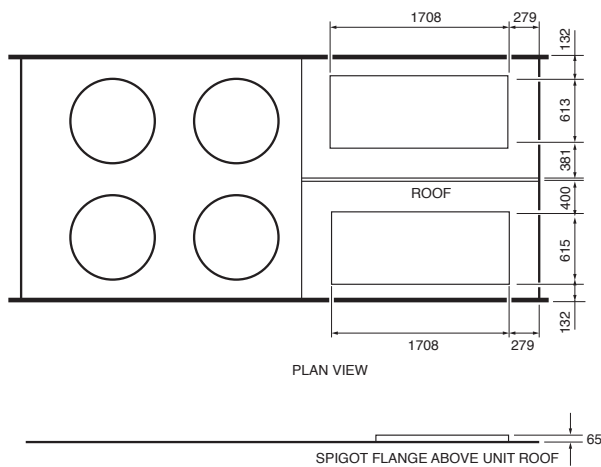

Downward Supply & Return Air versions

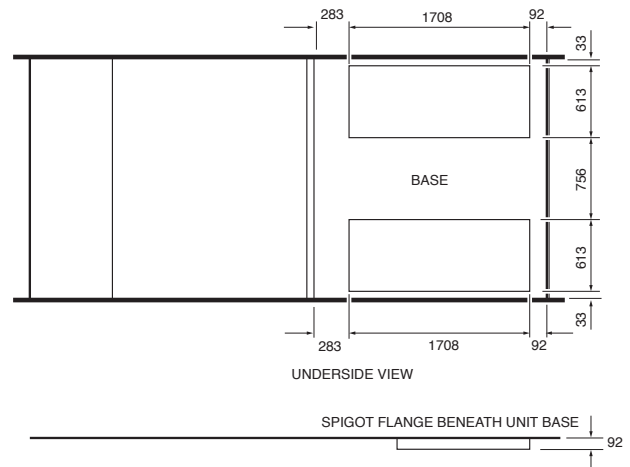

Materials and specifications are subject to change without notice due to the manufacturer's ongoing research and development programme.



Packaged Rooftop Air Conditioners R32

OPA Specifications

econex
nex gen R32 inverter

Model	OPA 1410 Econex	OPA 1410 Econex Pro
Cooling Capacity ¹ kW	145.7 (15.9~155.4)	151.7 (11.8~189)
Net Cooling Capacity (MEPS) ¹ kW	140.2	146
TCSPF ¹ (cold/mixed/hot)	3.50 / 3.34 / 3.41	4.78 / 4.33 / 4.21
EER / AEER (cooling)	3.05 / 3.04	3.24 / 3.22
Heating Capacity ² kW	142.1 (12.9~151.2)	144.8 (12.9~181)
HSPF ² (cold/mixed/hot)	2.89 / 2.95 / 2.94	3.71 / 3.97 / 4.16
COP / ACOP (heating)	3.59 / 3.58	3.35 / 3.34
Nominal Air Flow ³ l/s	8 100 (4 050~8 100)	8 100 (4 050~8 100)
Master Controller	UC8 ⁶	Carel c.pCO
Slave Controller/s	UC8	UC8 (x4)
Power Source ⁴	3 phase 400 V a.c. 50 Hz + N + E	
Refrigerant	R32 (Class A2L)	
Compressor type	inverter scroll (x1) + fixed scroll (x3)	inverter scroll (x4)
Indoor air fan type	backward curved EC plug (x4)	
Outdoor air fan type	EC axial (x4)	
Indoor Fan Max. Current A/ph.	4.6 (x4)	
Running Amps (Total) ¹ A/ph.	72 / 74 / 74	69 / 67 / 74
Max. Running Amps (Total) A/ph.	101 / 99 / 98	116 / 111 / 121
IP Rating	IP44 / IPX4 ⁵	
Finish	grey polyester powder coat	
Operating Range (outdoor ambient)		
Cooling	-10°C to 50°C	
Heating	-10°C to 25°C	
Weight (net) kg		
Unit	2 064	
Unit c/w Economiser	2 154	
Unit c/w Economiser + Reheat	n/a	2 230

Notes:

- ¹ Nominal Cooling Capacity (gross) at AS/NZS 3823 conditions:
 - Indoor Entering Air Temperature 27°C D.B., 19°C W.B.;
 - Outdoor Entering Air Temperature 35°C D.B.
- ² Heating Capacity at AS/NZS 3823 conditions:
 - Indoor Entering Air Temperature 20°C D.B.;
 - Outdoor Entering Air Temperature 7°C D.B., 6°C W.B.
- ³ Supply air flow at Nominal Cooling Capacity conditions stated above.
- ⁴ Voltage range: 380-440 V
- ⁵ Outdoor fan-guard clearance <100 mm (ref. IEC 60529)
- ⁶ Connects to optional TZT-100 room temperature controller

Compliance:

AS/NZS 3823.2:2013 Minimum Energy Performance standards
 AS/NZS 60335.2.40:2019 Safety of Electrical Appliances
 AS/NZS 61000.6.8:2021 EMC standard
 AS 4506:2005 Powder coat salt spray Class D High Marine

Materials and specifications are subject to change without notice due to the manufacturer's ongoing research and development programme.



Packaged Rooftop Air Conditioners R32

OPA Specifications

econex
nex gen R32 inverter

Model	OPA 1710 Econex	OPA 1710 Econex Pro
Cooling Capacity ¹ kW	169.7 (13.9~177.2)	183.6 (14.6~205.8)
Net Cooling Capacity (MEPS) ¹ kW	164.2	177.9
TCSPF ¹ (cold/mixed/hot)	3.53 / 3.37 / 3.39	5.38 / 4.80 / 4.60
EER / AEER (cooling)	3.09 / 3.08	3.07 / 3.06
Heating Capacity ² kW	170.7 (14.8~181.8)	184.1 (14.1~214.4)
HSPF ² (cold/mixed/hot)	2.71 / 2.85 / 2.87	3.12 / 3.37 / 3.52
COP / ACOP (heating)	3.36 / 3.35	3.25 / 3.24
Nominal Air Flow ³ l/s	8 200 (4 100~8 900)	8 200 (4 100~8 900)
Master Controller	UC8 ⁶	Carel c.pCO
Slave Controller/s	UC8	UC8 (x4)
Power Source ⁴	3 phase 400 V a.c. 50 Hz + N + E	
Refrigerant	R32 (Class A2L)	
Compressor type	inverter scroll (x1) + fixed scroll (x3)	inverter scroll (x4)
Indoor air fan type	backward curved EC plug (x4)	
Outdoor air fan type	EC axial (x4)	
Indoor Fan Max. Current A/ph.	4.6 (x2)	
Running Amps (Total) ¹ A/ph.	84 / 81 / 83	94 / 81 / 91
Max. Running Amps (Total) A/ph.	114 / 113 / 113	132 / 123 / 132
IP Rating	IP44 / IPX4 ⁵	
Finish	grey polyester powder coat	
Operating Range (outdoor ambient)		
Cooling	-10°C to 50°C	
Heating	-10°C to 25°C	
Weight (net) kg		
Unit	2 263	
Unit c/w Economiser	2 353	
Unit c/w Economiser + Reheat	n/a	2 437

Notes:

- 1 Nominal Cooling Capacity (gross) at AS/NZS 3823 conditions:
 - Indoor Entering Air Temperature 27°C D.B., 19°C W.B.;
 - Outdoor Entering Air Temperature 35°C D.B.
- 2 Heating Capacity at AS/NZS 3823 conditions:
 - Indoor Entering Air Temperature 20°C D.B.;
 - Outdoor Entering Air Temperature 7°C D.B., 6°C W.B.
- 3 Supply air flow at Nominal Cooling Capacity conditions stated above.
- 4 Voltage range: 380-440 V
- 5 Outdoor fan-guard clearance <100 mm (ref. IEC 60529)
- 6 Connects to optional TZT-100 room temperature controller

Compliance:

AS/NZS 3823.2:2013 Minimum Energy Performance standards
 AS/NZS 60335.2.40:2019 Safety of Electrical Appliances
 AS/NZS 61000.6.8:2021 EMC standard
 AS 4506:2005 Powder coat salt spray Class D High Marine

Materials and specifications are subject to change without notice due to the manufacturer's ongoing research and development programme.



Packaged Rooftop Air Conditioners R32

Specifications

econex
nex gen R32 inverter

Model	OPA 2110 Econex	OPA 2110 Econex Pro
Cooling Capacity ¹ kW	202.7 (32.1~208.8)	213.2 (32.1~238.5)
Net Cooling Capacity (MEPS) ¹ kW	193.8	206.5
TCSPF ¹ (cold/mixed/hot)	4.24 / 3.83 / 3.76	5.32 / 4.81 / 4.49
EER / AEER (cooling)	3.00 / 2.99	3.07 / 3.06
Heating Capacity ² kW	194.8 (14.9~205.9)	203.0 (14.9~243.6)
HSPF ² (cold/mixed/hot)	2.72 / 2.82 / 2.82	3.15 / 3.36 / 3.47
COP / ACOP (heating)	3.53 / 3.51	3.54 / 3.53
Nominal Air Flow ³ l/s	11 000 (5 500~11 000)	11 000 (5 500~11 000)
Master Controller	UC8 ⁶	Carel c.pCO
Slave Controller/s	UC8	UC8 (x4)
Power Source ⁴	3 phase 400 V a.c. 50 Hz + N + E	
Refrigerant	R32 (Class A2L)	
Compressor type	inverter scroll (x1) + fixed scroll (x3)	inverter scroll (x4)
Indoor air fan type	backward curved EC plug (x4)	
Outdoor air fan type	EC axial (x4)	
Indoor Fan Max. Current A/ph.	9.1 (x4)	
Running Amps (Total) ¹ A/ph.	108 / 108 / 110	108 / 101 / 111
Max. Running Amps (Total) A/ph.	155 / 156 / 158	158 / 153 / 159
IP Rating	IP44 / IPX4 ⁵	
Finish	grey polyester powder coat	
Operating Range (outdoor ambient)		
Cooling	-10°C to 50°C	
Heating	-10°C to 25°C	
Weight (net) kg		
Unit	2 577	
Unit c/w Economiser	2 667	
Unit c/w Economiser + Reheat	n/a	2 765

Notes:

- Nominal Cooling Capacity (gross) at AS/NZS 3823 conditions:
 - Indoor Entering Air Temperature 27°C D.B., 19°C W.B.;
 - Outdoor Entering Air Temperature 35°C D.B.
- Heating Capacity at AS/NZS 3823 conditions:
 - Indoor Entering Air Temperature 20°C D.B.;
 - Outdoor Entering Air Temperature 7°C D.B., 6°C W.B.
- Supply air flow at Nominal Cooling Capacity conditions stated above.
- Voltage range: 380–440 V
- Outdoor fan-guard clearance <100 mm (ref. IEC 60529)
- Connects to optional TZT-100 room temperature controller

Compliance:

AS/NZS 3823.2:2013 Minimum Energy Performance standards
 AS/NZS 60335.2.40:2019 Safety of Electrical Appliances
 AS/NZS 61000.6.8:2021 EMC standard
 AS 4506:2005 Powder coat salt spray Class D High Marine

Materials and specifications are subject to change without notice due to the manufacturer's ongoing research and development programme.



Packaged Rooftop Air Conditioners R32

Nomenclature

Series	Size	Type	Configuration	Options
O P A	1 4 1 0	R L T M 4 F P Q D	0 1 -	I Z
O - Outdoor P - Packaged A - Air Cooled	Divide by 10 to get approx. nominal Capacity in kilowatts	R - Reverse cycle L - Refrigerant R32 T - Three phase power supply M - Multiple compressor system #F - No. inverter compressors (of 4 systems) P - EC Plug fans Q - EC outdoor fans D - Advanced controller	01 - Std Horiz. S/A, Horiz. R/A 10 - Opp Hd Horiz. S/A, Down R/A 23 - Std Down S/A, Down R/A 32 - Opp Down S/A, Down R/A	I - Hot Gas Reheat Coil Z - Economiser



Packaged Rooftop Air Conditioners R32

Notes



Packaged Rooftop Air Conditioners R32

Notes

www.temperzone.com

Auckland

Head Office

38 Tidal Rd, Mangere, Auckland
Private Bag 93303, Otahuhu
New Zealand

Phone: (09) 279 5250

Email: sales@temperzone.co.nz

Sydney

Head Office

14 Carnegie Place, Blacktown
NSW 2148
PO Box 8064, Seven Hills West
NSW 2147, Australia

Phone: (02) 8822 5700

Email: sales@temperzone.com.au

Newcastle

Phone: (02) 4692 1155

Email: sales@mcintoshair.com.au

Launceston

Phone: (03) 6331 4209

Email: info@hvac-supplies.net

Hamilton

Phone: (07) 839 2705

Email: tzhilton@temperzone.com

Adelaide

Phone: (08) 8115 - 2111

Email: sasales@temperzone.com.au

Singapore

Phone: +65 6733 4292

Email: sales@temperzone.com.sg

Wellington

Phone: (04) 569 3262

Email: wgtn@temperzone.com

Melbourne

Phone: (03) 8769 7600

Email: vicsales@temperzone.com.au

Christchurch

Phone: (03) 379 3216

Email: chch@temperzone.com

Brisbane

Phone: (07) 3308 8333

Email: qldsales@temperzone.com.au

Perth

Phone: (08) 6399 5900

Email: reception@airskill.com.au



Materials and specifications are subject to change without notice due to the manufacturer's ongoing research and development programme.