

## *Operation Manual*

*INVERTER-DRIVEN  
MULTI-SPLIT SYSTEM  
HEAT PUMP  
AIR CONDITIONERS*

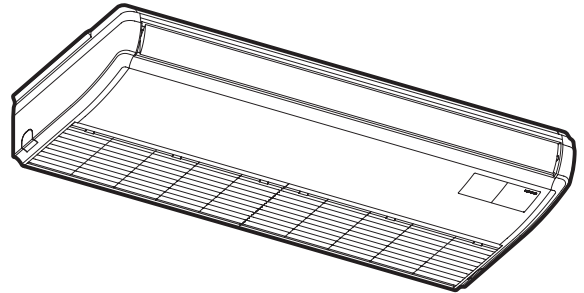

Type	Model
Ceiling	RPC-1.5FSR
	RPC-2.0FSR
	RPC-2.5FSR
	RPC-3.0FSR
	RPC-4.0FSR
	RPC-5.0FSR
	RPC-6.0FSR

### **IMPORTANT:**

*READ AND UNDERSTAND  
THIS MANUAL BEFORE  
USING THIS HEAT PUMP  
AIR CONDITIONERS.  
KEEP THIS MANUAL FOR  
FUTURE REFERENCE.*



## **IMPORTANT NOTICE**

- HITACHI pursues a policy of continuing improvement in design and performance of products. The right is therefore reserved to vary specifications without notice.
- HITACHI cannot anticipate every possible circumstance that might involve a potential hazard.
- This heat pump air conditioner is designed for standard air conditioning only. Do not use this heat pump air conditioner for other purpose such as drying clothes, refrigerating foods or for any other cooling or heating process.
- Do not install the unit in the following places. It may cause a fire, deformation, corrosion or failure.
  - \* Places where a fire, oil, steam or powder may enter directly to the unit such as right above a kitchen, etc.
  - \* Places where oil (including machinery oil) may be present in quantities.
  - \* Places where a lot of sulfide gas drifts such as in a hot spring.
  - \* Places where inflammable gas may generate or flow.
  - \* Places where strong salty wind blows such as coast regions.
  - \* Places with an atmosphere of acidity or alkalinity.
  - \* Places where gas from festering trash, etc. may generate.
- Do not install the unit in the place where silicon gas drifts. If the silicon gas attaches to the surface of heat exchanger, the fin surface repels water. As a result, drain water splashes outside of the drain pan and splashed water runs inside of electrical box. In the end, water leakage or electrical devices failure may occur.
- Pay attention to the following points when the unit is installed in a hospital or other facilities where an electromagnetic wave generates from a medical equipment.
  - \* Do not install the unit in the place where an electromagnetic wave is directly radiated to the electrical box, controller cable or wired controller.
  - \* Install the unit at least 3 meters away from an electromagnetic wave such as a radio.
- Do not install the unit in the place where the breeze directly catches animals and plants. It could adversely affect animals and plants.
- The installer and system specialist shall secure safety against the refrigerant leakage according to local regulations or standards. The following standards may be applicable, if local regulations are not available. International Organization for Standardization, ISO5149 or European Standard, EN378 or Japan Standard, KHS0010.
- No part of this manual may be reproduced without written permission.
- It is assumed that this heat pump air conditioner will be operated and serviced by English speaking people. If this is not the case, the customer should be provided with safety, caution and operating signs in the native language.
- If you have any questions, contact your distributor or dealer of HITACHI.
- This manual provides common descriptions, basic and advanced information to maintain and service this heat pump air conditioning unit which you operate as well for other models.
- This appliance must be used only by adult and capable people, having received the technical information or instructions to handle this appliance properly and safely.
- Children should be supervised to ensure that they do not play with the appliance.
- Cleaning and user maintenance shall not be made by children without supervision.
- This product is designed for standard air conditioning only.  
DO NOT use this product for specific purposes, such as restoring foods, animals & plants, precision devices, art objects, etc.

- DO NOT install the lower cover with motion sensor in the following places.  
It may cause misdetection, undetectable of motion or the deterioration of the motion sensor.
  - \* Places where ambient temperature changes drastically.
  - \* Places where excessive force or vibration is applied to the motion sensor.
  - \* Places where static electricity or electromagnetic waves may generate.
  - \* Places where is interference for infrared light such as glasses or mist in a detecting area.
  - \* Places where the lens for motion sensor is exposed in high temperature and humidity for a long time.
  - \* Places where fluid and corrosive gas exist.
  - \* Places where direct lights such as sunlight or headlight affect the motion sensor.
  - \* Places where hot air from a heater, etc. affects directly the motion sensor.
  - \* Places where the air flow returns to the motion sensor by hitting obstacles such as shelf, locker, etc.
  - \* Places where the blower devices such as ceiling fan, ventilating fan, etc. affect the air flow from the indoor unit.
  - \* Places where weather affects directly the surface of the motion sensor.
  - \* Places where the lens surface may smudge or be damaged such as a dusty environment.  
Pay attention that the detecting function will be decreased if the lens for motion sensor smudges.  
In this case, wipe off smudges by a cotton swab soaked alcohol (Isopropyl alcohol is recommended.) or a soft cloth.  
(When wiping off smudges on the lens for motion sensor, do not apply excessive force.  
If excessive force is applied, the resin lens may be damaged so that may cause malfunctions such as misdetection or undetectable of the motion.)
- This heat pump air conditioning unit has been designed for a specific temperature range. For optimum performance and long life, operate this unit within the range limits according to the table below.

#### Temperature

		Maximum	Minimum
Cooling Operation	Indoor	32°C DB/23°C WB	21°C DB/15°C WB
	Outdoor	48°C DB *	-10°C DB *
Heating Operation	Indoor	27°C DB	15°C DB
	Outdoor	15°C WB *	-20°C WB *

DB: Dry Bulb, WB: Wet Bulb

\* The temperature may change depending on the outdoor unit.

This manual should be considered as a permanent part of the air conditioning equipment and should remain with the air conditioning equipment.

## **CHECKING PRODUCT RECEIVED**

- Upon receiving this product, inspect it for any shipping damage.  
Claims for damage, either apparent or concealed, should be filed immediately with the shipping company.
- Check the model number, electrical characteristics (power supply, voltage and frequency) and accessories to determine if they are correct.

The standard utilization of the unit shall be explained in these instructions.

Therefore, the utilization of the unit other than those indicated in these instructions is not recommended.

Please contact your local agent, as the occasion arises.

HITACHI's liability shall not cover defects arising from the alteration performed by a customer without HITACHI's consent in a written form.

# TABLE OF CONTENTS

1. Safety Summary .....	1
2. Before Operation.....	6
2.1 Efficient Use of Indoor Unit.....	6
2.2 Efficient Use of Cooling and Heating.....	6
3. Name of Parts and Indication of Safety Consideration .....	7
3.1 Indoor Unit.....	7
3.2 Wired Controller .....	8
4. Operation Method .....	9
5. Setting Method.....	9
6. Operation .....	9
7. Operation Lock.....	9
8. Menu Operation .....	9
9. Motion Sensor.....	10
9.1 Function.....	10
9.2 Details for Motion Sensor Control .....	10
9.3 Descriptions for Setting Items .....	11
9.4 Setting of Motion Sensor .....	11
9.5 FrostWash .....	12
9.6 Prevent Excessive Cooling.....	12
9.7 Airflow Optimization in Heating Mode .....	12
10. Other Indications.....	13
10.1 In Normal Condition.....	13
10.1.1 Central Control.....	13
10.1.2 Motion Sensor Control .....	13
10.1.3 Defrost .....	13
10.1.4 Operation Control .....	13
10.1.5 Cold Draft Control during Cooling Operation .....	14
10.1.6 Automatic Heating/Cooling Operation .....	14
10.1.7 Setback Operation .....	15
10.2 In Abnormal Condition .....	15
10.2.1 Abnormality.....	15
10.2.2 Power Failure.....	15
10.2.3 Electromagnetic Interference (EMI).....	15
11. Automatic Control .....	15
12. Simultaneous Operation .....	16
13. Maintenance .....	16
13.1 Daily Maintenance.....	16
13.1.1 Cleaning Air Filter .....	16
13.1.2 Removing, Attaching and Cleaning Air Inlet Grille .....	18
13.2 Maintenance Beginning and Ending of Use .....	18
14. Troubleshooting .....	19
14.1 This is Not Abnormal .....	19
14.2 Before Contact .....	20
14.3 Contact Distributor.....	21
14.4 Alarm Code .....	22



## 1. Safety Summary

< Signal Words >

- Signal words are used to identify levels of hazard seriousness. Definitions for identifying hazard levels are provided below with their respective signal words.



: DANGER indicates a hazardous situation which, if not avoided, will result in death or serious injury.



: WARNING indicates a hazardous situation which, if not avoided, could result in death or serious injury.



: CAUTION, used with the safety alert symbol, indicates a hazardous situation which, if not avoided, could result in minor or moderate injury.

**NOTICE**

: NOTICE is used to address practices not related to personal injury.

**NOTE**

: NOTE is useful information for operation and/or maintenance.

## DANGER

- Do not perform the installation work, refrigerant piping work, drain pump, drain piping and electrical wiring connection without referring to our installation manual. If the instructions are not followed, it may result in a water leakage, electric shock or a fire.
- This machine uses refrigerant R410A or refrigerant R32.  
The type of enclosed refrigerant is described in the specification nameplate and caution nameplate attached to the outdoor unit. When installing, repairing, or relocating, do not mix substances other than the refrigerant described on the specification nameplate or caution nameplate attached to the outdoor unit. Also, do not mix refrigerant R410A and refrigerant R32. Entering non-designated refrigerants, air, oxygen, flammable substances such as propane or alcohol may cause explosion, fire or injury.
- Do not pour water into the indoor unit. These products are equipped with electrical parts. If poured, it will cause a serious electrical shock.
- Do not open the service cover for the indoor or outdoor unit without turning OFF the main power supply.
- Do not touch or adjust safety devices inside the indoor unit or outdoor unit. If these devices are touched or readjusted, it may cause a serious accident.
- Refrigerant leakage can cause difficulty with breathing due to insufficient air. Turn OFF the main switch, extinguish any naked flames and contact your service contractor, if refrigerant leakage occurs.
- Make sure that a refrigerant leak test has been performed. Refrigerant (Fluorocarbon or Difluoromethane) for this unit is non-toxic, and odorless. If the refrigerant should somehow escape and come into contact with flame, toxic gas will form. This gas is heavier than air and will settle near floor areas and spread where it can cause suffocation to those nearby. In addition, difluoromethane is flammable and can cause fire.
- The installer and system specialist shall secure safety against refrigerant leakage according to local regulations or standards.
- Use an ELB (Earth Leakage Breaker).  
In the event of fault, there is danger of an electric shock or a fire if it is not used.
- Do not install the outdoor unit where there is high level of oil mist, flammable gases, salty air or harmful gases such as sulfur.
- For installation, firmly connect the refrigerant pipe before the compressor starts operating.  
For maintenance, relocation and disposal, remove the refrigerant pipe after the compressor stops.
- Do not perform a short-circuit of the protection device such as the pressure switch when operating.  
It may cause a fire and explosion.
- Do not alter the product and the electrical wiring. It will cause a serious accident.
- Do not install the indoor unit in flammable environment to avoid fire or an explosion.
- As the new refrigerant (R410A or R32) is adopted, the refrigerant oil has been also changed, which tends to be affected by foreign matters such as moisture, oxide film, fat. Perform the installation work with care not to enter moisture, dust or old refrigerant into the refrigerant cycle, otherwise the parts such as expansion valve bite foreign matter and the operation may be unavailable.
- Do not insert the drain pipe to the drainage trench where corrosive gases occur. Poisonous gases flow into the room, so that may cause the poisoning.
- Cleaning inside Existing Refrigerant Pipe
  - \* Non-flammable and nontoxic detergent shall be used to clean the pipe. If not, it may cause a fire.
  - \* Ventilate well, otherwise cleaning the pipe in the sealed room may cause suffocation. Additionally, if the detergent contacts a fire and is under high temperature, it may cause generation of toxic gas.
  - \* The detergent after cleaning shall be recovered. It is prohibited to emit fluorocarbons to the atmosphere without permission.



## **WARNING**

- The installation work shall be performed by the specialist installer.  
If it is not completed, it may cause a water leakage, an electric shock, a fire or falling down the unit.
- Perform the electrical work according to Installation Manual and all the relevant regulation and standards.  
If the instructions are not followed, an electrical shock and fire may occur due to insufficient capacity and inadequate performance.
- The electrical wiring work must be performed by authorized installers.  
If not performing the electrical work completely or a capacity shortage of the power circuit, it may cause an electric shock or a fire.  
Additionally, if the earth wire is disconnected, it may cause an electric shock.  
Contact the authorized installer and connect the earth wiring.
- If the circuit breaker or fuse is often activated, stop the system and contact your service contractor.
- Check that the ground wire is securely connected. If the unit is not correctly grounded, it will lead electric shock. Do not connect the ground wiring to a gas piping, water piping, lighting conductor or ground wiring for telephone.
- Use specified cables between units and choose the cables correctly. If not, an electrical shock or fire may occur.
- Ensure that the wiring terminals are tightened securely with the specified torques. If not, generating fire or an electrical shock at the terminal connection part may occur.
- Connect a fuse of specified capacity.
- Protect the wires, electrical parts, etc. from rats or other small animals.  
If not protected, rats may gnaw at unprotected parts and which may lead to a fire.
- Fix the cables securely. External forces on the terminals could lead to a fire.
- Provide a sufficiently strong foundation. If not, the unit may fall down and it may lead to injuries.
- If the indoor unit is installed in a small room and the refrigerant gas leakage occurs, the leaked refrigerant gas fills the room and it may cause suffocation.  
Do not exceed the maximum permissible concentration of the refrigerant gas in the room.  
Consult with distributor for countermeasure such a ventilation system, etc.
- Before performing any brazing work, check to ensure that there is no flammable material around.  
When using the refrigerant be sure to wear leather gloves to prevent cold injuries.
- Do not install the unit in a place where oil, vapor, organic solvent and corrosive gas (ammonia, sulfur compound and acid) may be present in quantities.  
It may cause refrigerant leakage due to corrosion, electrical shock, deteriorated performance and breakage.
- Do not insert a finger or stick into the air outlet and the air inlet.  
It could cause injury due to touch the rotating fan or electrical devices.
- Do not control the wired controller by wet hand.  
It may cause failure of the wired controller or an electric shock.
- Do not use any sprays such as an insecticide, lacquer, hair spray or other flammable gases within approximately one (1) meter from the system. It may generate a fire.
- Do not install the indoor unit in a place where the air flow blows directly to heating appliances.  
It may cause incomplete combustion of the heating appliances.

- When the indoor unit is operated with heating appliances, ventilate a room sufficiently. If not, it may cause suffocation.
- Turn OFF the main power source immediately if the safety device is frequently activated or the main power source switch does not work. If not, it may cause an electric shock, a fire or explosion because there are possibilities of the electrical leakage or overcurrent, etc. Contact your distributor or contractor.
- If abnormality (burnt odor, etc.) occurs, stop the operation and turn OFF the main power source immediately. If not, it may cause breakage of the product, an electric shock or a fire. Contact your distributor or contractor.
- Do not operate the indoor unit without the electrical box cover and the air inlet grille. It is unusually dangerous that the indoor fan and electrical parts are exposed. In addition, it may cause an electric shock due to touch the electrical parts.
- When the air conditioner is necessary to be repaired or relocated, contact your distributor or contractor. If the repair and the installation are not completed, it may cause an electric shock or a fire.
- Do not perform the installation work, the refrigerant piping work, the drain pump, the drain piping and electrical wiring connection without turning OFF the main power source. It may cause an electric shock or injury.
- Perform the maintenance work with stable footing. If not, it may cause falling or injury.
- Do not spray water or detergent to the indoor unit when performing the maintenance work. It may cause an electric shock or a fire by electrical short-circuit.
- Protect securely the electrical parts and connectors not to splash water when performing the maintenance work. If not, it may cause an electric shock or a fire by electrical short-circuit.
- The inside piping charged refrigerant is high pressure. Perform securely the refrigerant piping work by the authorized installer. If not, it may cause a serious accident.





---

**NOTE**

---

**Additional safety information for R32 refrigerant air conditioner and heat pump according to IEC 60335-2-40: 2018.**

Explanation of symbols displayed on the indoor unit or outdoor unit.

	<b>WARNING</b>	This symbol shows that this equipment uses a flammable refrigerant (A2L). If the refrigerant is leaked, together with an external ignition source, there is a possibility of ignition.
	<b>CAUTION</b>	This symbol shows that the Operation Manual should be read carefully.
	<b>CAUTION</b>	This symbol shows that a service personnel should be handling this equipment with reference to the Installation Manual.
	<b>CAUTION</b>	This symbol shows that there is information included in the Operation Manual and/or Installation Manual.

---

## **CAUTION**

- Do not step or put any material on the product.
- Do not put any foreign material on the unit or inside the unit.
- Do not turn OFF the main power source of the indoor unit during the season of heating and cooling. The water can not be discharged forcedly so that overflows from the drain pan. As the result, the floor and the ceiling surface are smudged.
- Hold the air filter and the air inlet grille by hand when attaching (removing). If not, it may cause falling or injury.
- Do not blow cold air to a person for a long time or overcool. It may cause deterioration of physical condition and health impairment.
- Do not handle the unit by one person. Although the unit may be packed by polypropylene band, do not use it for transportation. If the unit is handled by hand, the fin surface of heat exchanger causes a cut.

## **NOTICE**

- Do not install the indoor unit, outdoor unit, wired controller and cable within approximately 3 meters from strong electromagnetic wave radiators such as medical equipments.
- Supply electrical power to the system to energize the oil heater for 12 hours before startup after a long shutdown.
- Make sure that the outdoor unit is not covered with snow or ice, before operation.
- In some cases, the packaged air conditioner may not be operated normally under the following cases.
  - \* In case that electrical power for the packaged air conditioner is supplied from the same power transformer as the device\*.
  - \* In case that the power source wires for the device\* and the packaged air conditioner are located close to each other.

Device\*: (Ex) Lift, container crane, rectifier for electric railway, inverter power device, arc furnace, electric furnace, large-sized induction motor and large-sized switch.  
It consumes a large quantity of electrical power.

Regarding the cases mentioned above, surge voltage may be inducted in the power supply wiring for the packaged air conditioner due to a rapid change in power consumption of the device and an activation of switch.

Therefore, check the field regulations and standards before performing electrical work in order to protect the power supply for the packaged air conditioner.

- Do not install the unit in the place where the air flow directly catches to animals or plants. It could be the cause of adverse affect to animals or plants.
- Do not create an upper-slope or rise for the drain piping since drain water can flow back to the indoor unit and leakage into the room will occur.
- Do not apply excessive force to the flare nut when tightening. If it is applied, the flare nut may crack due to aged degradation and refrigerant leakage may occur. Use the specified tightening torque.

## **NOTE**

- It is recommended that the room will be ventilated every 3 to 4 hours.
- The heating capacity of the heat pump unit is decreased according to the outdoor air temperature. Therefore, it is recommended that auxiliary heating equipment be used in the field when the units is installed in a low temperature region.

## 2. Before Operation

### 2.1 Efficient Use of Indoor Unit

- **Do not leave a window or a door open.**  
The operating efficiency will be decreased.  
It may cause dew condensation of the indoor unit. (Ventilate a room sufficiently too.)
- **Attach a curtain or a blind to a window.**  
Direct sunlight is prevented and the cooling efficiency will be increased.
- **Do not use heating appliances during the cooling operation as possible.**  
The cooling efficiency will be decreased. It may cause dew condensation and dropping dew.
- **Use a circulator if warm air stays around ceiling.**  
The comfortability will be increased. Contact your distributor for the detail.
- **Turn OFF the main power source if the indoor unit is not used for a long time.**  
If not, the standby electricity charges will have to be paid even if the indoor unit is unused.

### 2.2 Efficient Use of Cooling and Heating

**COOLING**

(1) Air Flow Direction  
The appropriate air outlet angle is approx. 10°.  
If the cooling is not sufficient, change the air flow direction.

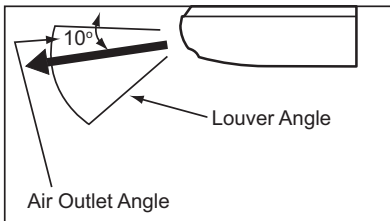

Air Outlet Angle

Louver Angle

(Refer to the item 4.3 on the operation manual of PC-ARF1.)

(2) Air Flow Volume  
"MED" should be usually used. If the air flow volume is set as "HIGH", the air flow will be spread wider than "MED".

(3) Temperature  
The recommended set temperature is 27 to 29°C.  
If the cooling is not sufficient, set the lower temperature.

**HEATING**

(1) Air Flow Direction  
The appropriate air outlet angle is approx. 35°.  
If the heating is not sufficient, change the air flow direction.

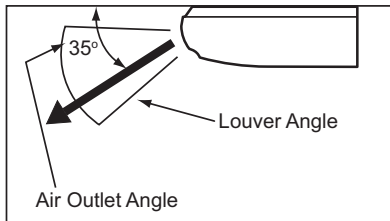

Air Outlet Angle

Louver Angle

(Refer to the item 4.3 on the operation manual of PC-ARF1.)

(2) Air Flow Volume  
"MED" should be usually used. If the air flow volume is set as "HIGH", the air flow will be spread wider than "MED".

(3) Temperature  
The recommended set temperature is 18 to 20°C.  
If the heating is not sufficient, set the higher temperature.

---

### NOTE

---

< About SET FREE Series >

When the number of indoor unit or the operating mode is changed, the air outlet temperature may be changed and the indoor temperature is changed. In this case, set as follows.

- During Cooling: Lower slightly the temperature setting.
  - During Heating: Raise slightly the temperature setting.
-

### 3. Name of Parts and Indication of Safety Consideration

The safety considerations are indicated on the indoor unit in order to be used safely. Read and understand this manual before using the indoor unit.

#### 3.1 Indoor Unit

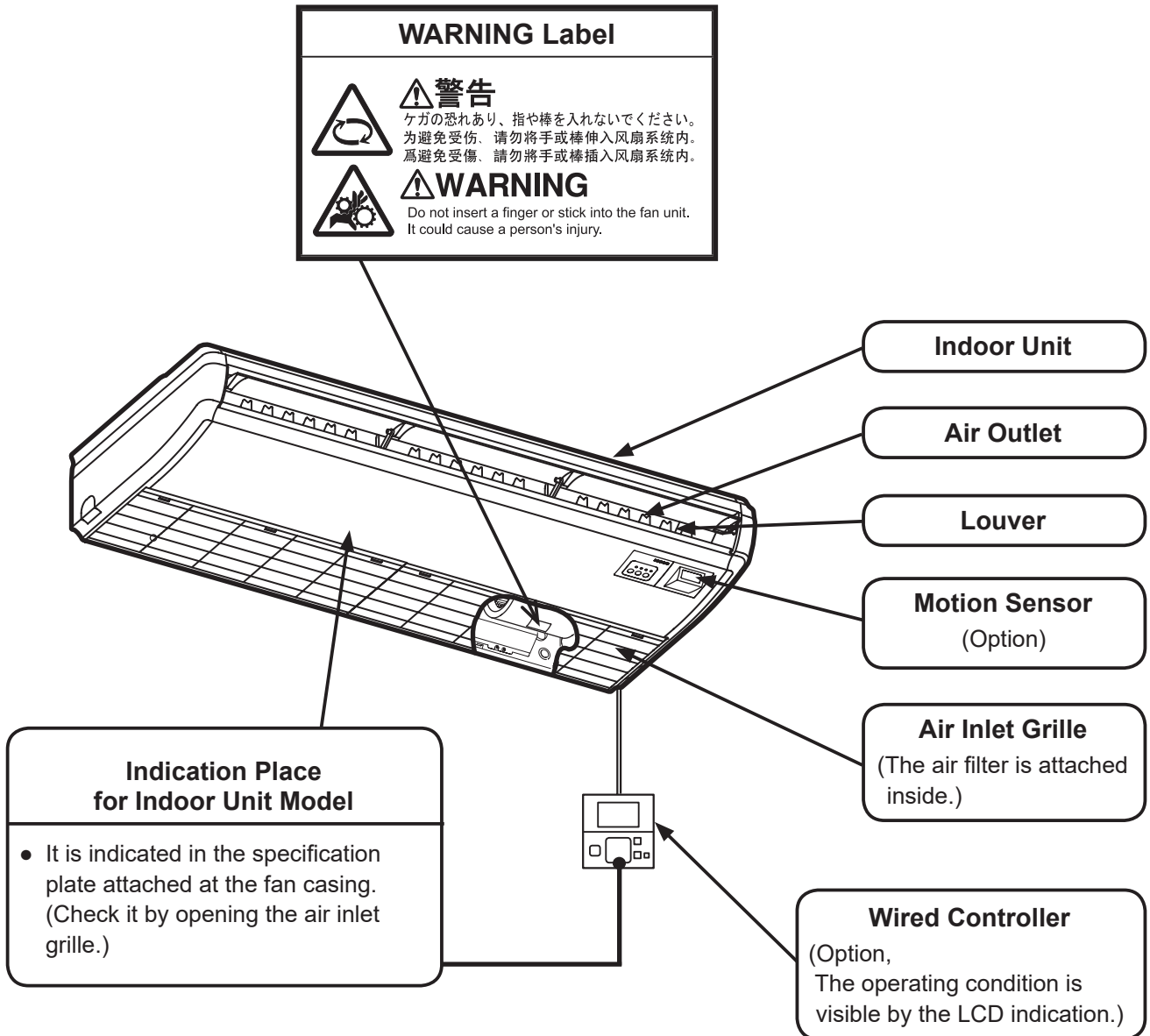

#### NOTE

- Press lightly the switches to control the wired controller.
- Do not press the wired controller by sharp objects such as pen. It may cause breakage of control part.
- To control the indoor unit by the optional wireless controller, the detail shall be referred to the installation manual of itself.

### 3.2 Wired Controller

Model: PC-ARF1 (Optional)

(The example below references the control panel and all adjustable settings. The wired controller display may be different during actual operation.)

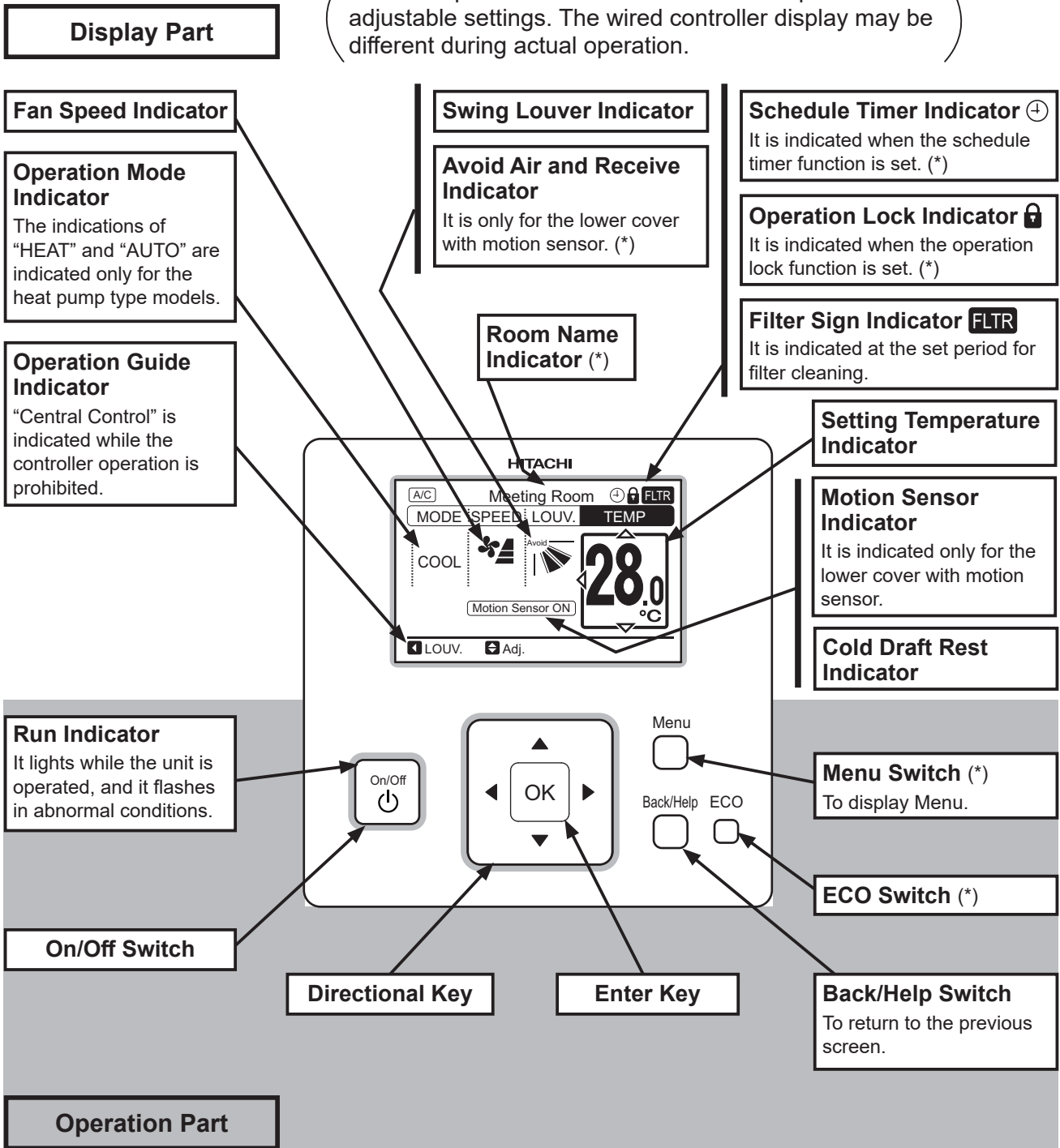

#### NOTE

- This manual shows example PC-ARF1 is utilized. If other models of the controller are utilized, operate the unit according to the manual for that controller.
- Press the switches lightly to control the wired controller. Do not press the wired controller with a sharp object such as a pen. It may cause damage to the control part.
- (\*): For details description, refer to the operation manual for the wired controller.

## 4. Operation Method

Refer to the operation manual of PC-ARF1.

## 5. Setting Method

Refer to the operation manual of PC-ARF1.

- **Adjusting Vertical Deflector**  
The vertical deflectors which consist 3 sets of deflector are connected by the connecting rod. Adjust the vertical deflectors by hand to the required direction. To adjust them, stop swinging the louver during the operation.

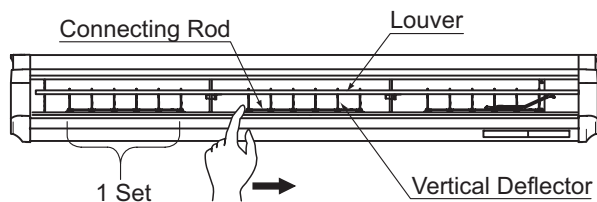

- **Automatic Setting of Louver**  
The swing louver is stopped and moved by controlling the wired controller. When "Stop" switch is pressed from the wired controller, the swing louver will be closed automatically and the operation is stopped.

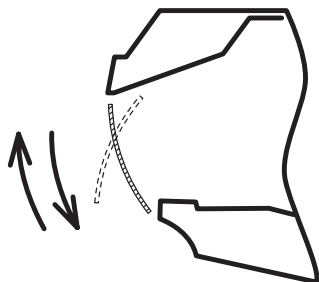

- When "RUN" switch is pressed from the wired controller, the swing louver will be opened automatically. At this time, for cooling, dry and fan operation, the indoor unit is operated with the set temperature after the fan speed "SLOW" operation is performed for approximately 20 seconds.  
During the heating operation, the movement is same as "Hot Start during Heating Operation". (Refer to the item 11.)

- **Swing Louver Direction during Heating Operation**

- \* When the heating operation starts
- \* When the defrost operation starts
- \* When thermo-controller activates

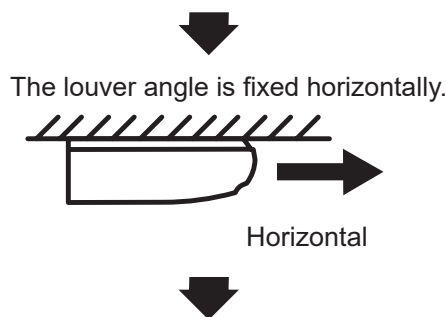

When the discharge temperature is higher than 30°C, the louver angle is automatically returned to the setting condition.

## CAUTION

**Do not move the louver by hand. If moved, the louver mechanism will be damaged and the air flow direction may not be set.**

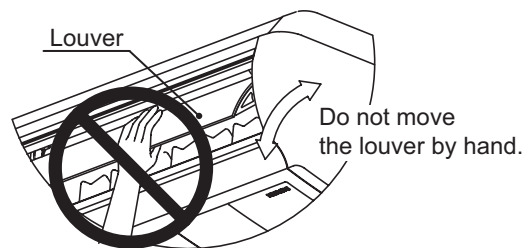

## 6. Operation

Refer to the operation manual of PC-ARF1.

## 7. Operation Lock

Refer to the operation manual of PC-ARF1.

## 8. Menu Operation

Refer to the operation manual of PC-ARF1.

## 9. Motion Sensor

This setting is available only for the motion sensor kit.

### 9.1 Function

- The motion sensor detects a human activity by the change of the infrared light.  
This function saves the air conditioning capacity (adjusting the set temperature, the air flow volume and the air flow direction) automatically depending on a situation.
- The operation after the motion sensor detects as absence can be selected from “ON”, “Stand-by” or “OFF” on the wired controller with the capacity saving.

## NOTICE

- Do not use the motion sensor function when a baby or a handicapped person stays by oneself. The motion sensor may detect as absence and the operation may be stopped in the case of staying for long time with a bit motion.
- The motion sensor detects the human activity. However, if someone is in a room with a bit motion, the motion sensor may detect as absence.
- The motion sensor may detect as human activity if the indoor unit with the motion sensor is installed near a moving object (ex. swing operation of a heating appliance) which is difference in temperature against atmosphere.
- In the case that the indoor units are operated by 2 wired controllers, the motion sensor setting is available only from the main wired controller.
- The indoor unit operation can be stopped by the motion sensor control.

#### NOTE:

The indoor unit without the motion sensor and the indoor unit with the motion sensor can be mixed to install.

In this case, when the operation is stopped by the motion sensor control, the indoor unit without the motion sensor will also stop the operation.

- While the air conditioning capacity is saved or the operation is stopped by the motion sensor control, “Motion sensor is activated” is displayed on LCD.

- If the function “Prohibiting operation by wired controller” is used from the centralized controller, select the command “ON” or “Stand-by” in “If absent” at the motion sensor control setting.  
If “OFF” is selected, the motion sensor control can not be performed correctly as follows.

- \* In the case that “OFF” is selected in the motion sensor control setting and “Prohibiting operation by wired controller” (for all items) is set by the centralized controller, the operation will not be stopped even if the motion sensor control function changes to the stoppage condition.
- \* In the case that “OFF” is selected in the motion sensor control setting and “Prohibiting operation by wired controller” (for part of items) is set by the centralized controller, the indoor unit operation can not be restarted from the centralized controller although the operation can be stopped under the stoppage condition by the motion sensor control function.

### 9.2 Details for Motion Sensor Control

The motion sensor control adjusts automatically the following items depending on a situation.

- \* Setting Temperature:  
The temperature is adjusted 1°C or 2°C for saving capacity.
- \* Air Flow Volume:  
The air flow volume is adjusted to lower one volume or to “Slow” (except during the dry operation).
- \* Air Flow Direction:  
The air flow direction is adjusted to horizontal.



### 9.3 Descriptions for Setting Items

- Motion Sensor Setting

The operation mode for activations for function can be selected as follows:

- \* ALL MODES:

Function is available when the operation mode is "COOL", "DRY", "HEAT" or "FAN".

- \* COOL+DRY:

Function is available when the operation mode is "COOL", "DRY" or "FAN".

- \* HEAT:

Function is available when the operation mode is "HEAT".

- \* OFF:

Functions is not available.

(The default setting is "ALL MODES".)

- If absent

"If absent" is set for the indoor unit operation after the motion sensor detects as absence for set time in "Check interval". The operation can be selected from "ON", "Stand-by" or "OFF" on the wired controller.

(The default setting is "ON".)

- \* ON:

The operation is continued with saving the capacity after detected as an absence.

If the human activity is detected for a period of time, the normal operation will be performed again.

- \* Stand-by:

The operation mode is the fan operation at "Slow" speed. If the human activity is detected for a period of time, the normal operation will be performed again.

- \* OFF:

The operation is stopped by the wired controller when all the indoor units with motion sensor detect absence which are connected with same wired controller.

If the human activity is detected for a period of time by the stoppage, the normal operation is performed again.

- Check Interval

When the motion sensor detects an absence at selected check interval time, the function "If absent" will be executed. The interval can be selected from 30, 60, 90 120 or 180 minutes.

(The default setting is 30 minutes.)

### 9.4 Setting of Motion Sensor

(1) Press "Menu".

Select "Motion Sensor Setting" from the menu by pressing "Δ" or "∇" and press "OK".

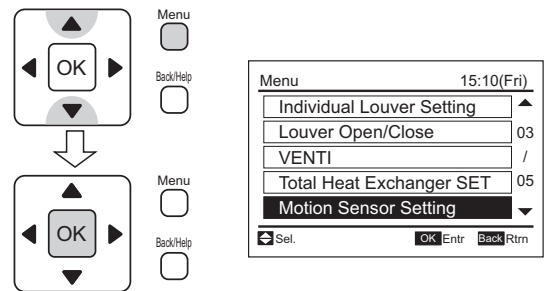

(2) "Motion Sensor Setting" is displayed.

The highlighted item is shifted to "Sensor", "If absent" and "Check interval" by pressing "Δ" or "∇".

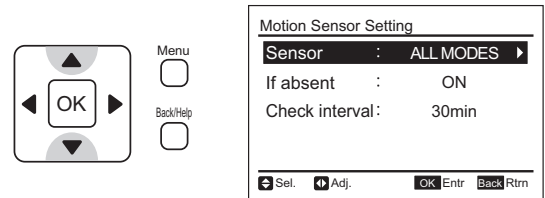

- To set "Sensor", move to procedure (3).
- To set "If absent", move to procedure (5).
- To set "Check interval", move to procedure (7).

(3) Press "Δ" or "∇" and select "Sensor".

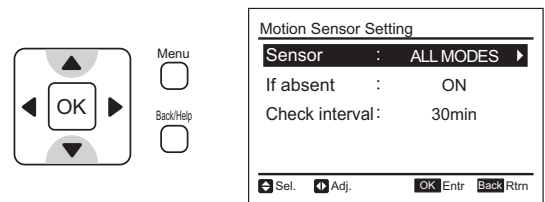

(4) The display is switched "ALL MODES", "COOL+DRY", "HEAT" and "OFF" in order by pressing "◀" or "▶" and change the setting. If other settings are not required, move to procedure (9).

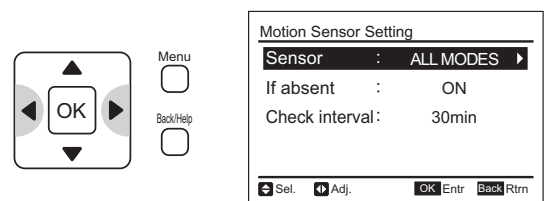

- (5) Press “△” or “▽” and select “If absent”.

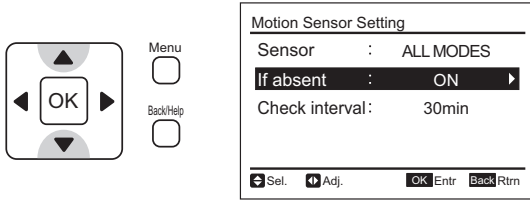

- (6) The display is switched “ON”, “Stand-by” and “OFF” in order by pressing “◀” or “▶” and change the setting. If other settings are not required, move to procedure (9).

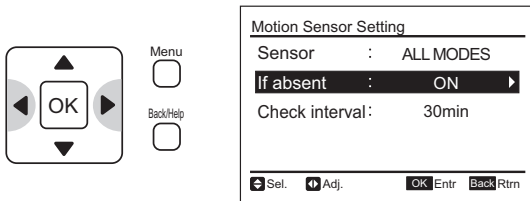

- (7) Press “△” or “▽” and select “Check interval”.

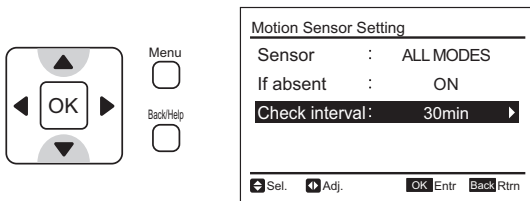

- (8) The display is switched “30min”, “60min”, “90min”, “120min” and “180min” in order by pressing “◀” or “▶” and change the setting. If other settings are not required, move to procedure (9).

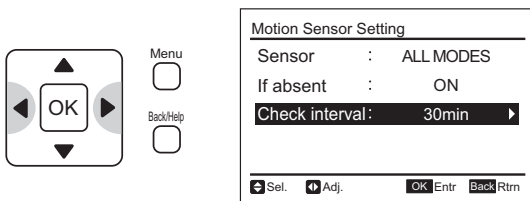

- (9) Press “OK” after the setting is completed. The confirmation screen will be displayed. Select “Yes” by pressing “◀” or “▶” and press “OK”. The motion sensor setting will be confirmed and the screen will return to the normal mode (operation mode indication).

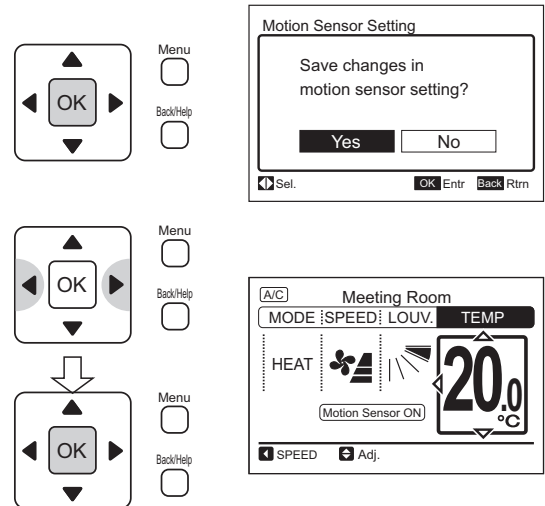

## 9.5 FrostWash

Refer to the manual for PC-ARFG.

## 9.6 Prevent Excessive Cooling

Refer to the manual for PC-ARFG.

## 9.7 Airflow Optimization in Heating Mode

Refer to the manual for PC-ARFG.

## 10. Other Indications

### 10.1 In Normal Condition

#### 10.1.1 Central Control

- When remote control operation is restricted (all functions)  
 "Central Control" and "🔒" are turned ON.  
 If the remote control restriction is set from the central controller, the settings for RUN, Operation Mode, Temperature Setting, Fan Speed and Louver will not be accessible from the controller.

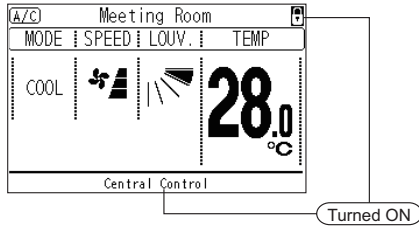

- When remote control operation is restricted (some functions)  
 "🔒" is turned ON.  
 The function operation which is restricted from the central controller cannot be set.

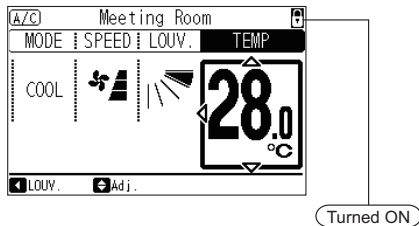

#### 10.1.2 Motion Sensor Control

"Motion sensor ON" is turned ON during the motion sensor control.  
 In this case, the operation is performed with saving the capacity or stopped by the motion sensor control.

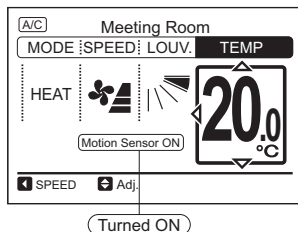

#### 10.1.3 Defrost

"Defrost" is turned ON and the indoor fan stops during defrosting operation. The louver is fixed in a horizontal position.

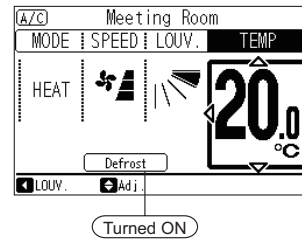

- Operation Stoppage during Defrosting Operation

If the unit operation is stopped during defrosting operation, the operation continues with the RUN indicator (Green) turned OFF. The operation stops after defrosting operation.

#### 10.1.4 Operation Control

- Supplying Main Electrical Power

"Preheating" is turned ON at power-on.  
 In this case, the compressor is under preheating. Do not turn OFF the power supply of the outdoor unit during the high season for Cooling/Heating operation. Otherwise, the operation might not be available for Max. 4 hours.

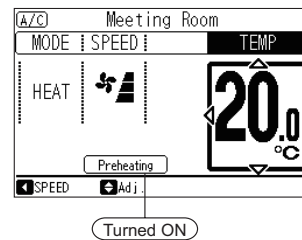

- During Hot Start (for Heating Operation Only)

"HOT-START" is turned ON.

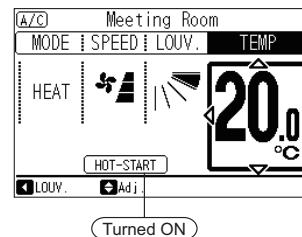

• Different Operation Mode

When the operation mode set by the wired controller is different from the outdoor unit operation mode, the actual operation mode flashes on the LCD.  
(except for the heat recovery system models)

The current operation mode and the message "Other remote are in HEAT setting" will be flashing.

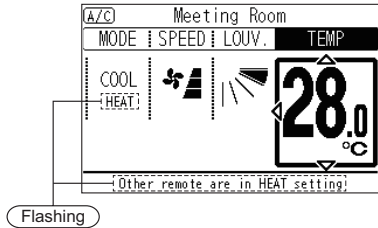

The above display shows the case that the cooling mode is set from the wired controller while actual operation mode of the outdoor unit is heating.

# NOTICE

- The "Control Cool Air" function may not have much effect depending on the operating conditions of the outdoor unit.
- In case one outdoor unit is connected to multiple indoor units and the rate of these indoor units which are equipped with the "Control Cool Air" function is low, this function may not have much of an effect.
- When this function is set, it may take a few minutes to cool the entire room.
- While this function is activated, "Cold draft rest." is displayed on the LCD control panel of the wired controller.

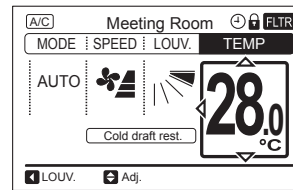

### 10.1.5 Cold Draft Control during Cooling Operation

(1) Function

This function controls the overcooling airflow to prevent of cold draft.

(2) Setting Items

- \* OFF : This function is not available.
- \* LOW : The over-cooling airflow temperature is controlled low degree.
- \* MID : The over-cooling airflow temperature is controlled medium degree.
- \* HIGH : The over-cooling airflow temperature is controlled high degree.

(The default setting is "OFF")

(3) Supplement of Function

- The discharge air temperature is elevated higher in "HIGH" > "MID" > "LOW" order.
- The recommended discharge air temperature setting is "LOW".  
(When feeling cold at "LOW", change the setting to "MID" or "HIGH".)
- \* This function also reduces the formation of dew condensation on the indoor unit when the discharge air temperature is lower than the inlet air temperature in a very humid room.  
(The recommended discharge air temperature setting is "LOW".)

An automatic heating/cooling operation requires extra settings.  
Refer to the "Installation & Maintenance Manual" for the wired controller and the "Service Manual" for details.

### 10.1.6 Automatic Heating/Cooling Operation

In case dual setpoint is selected in automatic heating/cooling operation, during auto mode both cooling setpoint and heating setpoint can be selected.

By default, temperature when the heating/cooling mode changes are as follows.

Cooling mode changes to heating mode when the indoor temperature is heating setpoint -1°C.  
Heating mode changes to cooling mode when the indoor temperature is cooling setpoint +1°C.

If the temperature for changing modes requires to be changed, refer to the "Installation & Maintenance Manual" for the wired controller and the "Service Manual" for details.

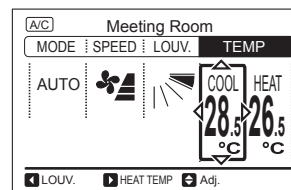

A setback operation requires extra settings. Refer to the “Installation & Maintenance Manual” for the wired controller and the “Service Manual” for details.

### 10.1.7 Setback Operation

Setback operation is mainly to sustain a comfort room air temperature while occupants are out of the room.

If the setback operation is enabled, the setpoint is adjusted for setback.

During this time, “Setback” is displayed on the LCD.

Refer to the “Installation & Maintenance Manual” for the wired controller and the “Service Manual” for details.

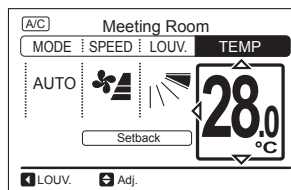

## 10.2 In Abnormal Condition

### 10.2.1 Abnormality

- The RUN indicator (Red) is flashing.
- The indoor unit number, the alarm code, the unit model code and the number of the connected indoor units are displayed on the LCD.
- In case that the plural indoor units are connected to one wired controller, select the object indoor unit on the LCD to display the information.

### 10.2.2 Power Failure

- All the indications are OFF.
- Once the unit stops due to power failure, the operation will not restart even after the power recovers. Perform the starting procedures again.
- In case of the instantaneous power failure for 2 seconds or less, the standard unit restarts the operation automatically.

### 10.2.3 Electromagnetic Interference (EMI)

There could be a case that all the indications are OFF and the unit is stopped. This is due to the activation of the micro computer for the unit protection from the Electromagnetic Interference (EMI). Perform the starting procedures again.

## 11. Automatic Control

The system is equipped with the following functions.

### NOTE

Except in the case of a long period of shutdown, keep the main power switch ON. The drain discharge mechanism is operated if the drain level is higher than the setting.

- **Three Minute Guard (Enforced Stoppage)**  
This function is utilized to protect the compressor. When the function is valid, the compressor does not operate the unit for at least 3 minutes after it stops operating, with the RUN indicator turned ON. The operation restarts automatically after 3 minutes.
- **Three Minute Guard (Enforced Operation)**  
This function is utilized to protect the compressor. When the function is valid, the compressor does not stop operating for at least 3 minutes after it starts operating. However, if all indoor units in the system are stopped by the wired controller, the compressor will stop operating.
- **Oil Return Operation**  
This function is utilized to prevent oil accumulation in the heat exchanger of out-of-service indoor unit at cooling operation. If the indoor unit is stopped continuously for more than 2 hours, this function is operated for a few minutes.
- **Frost Prevention During Cooling Operation**  
This function is utilized to prevent frost formation on the indoor unit heat exchanger. When the indoor unit is operated at low discharge air temperature, the cooling operation switches to fan operation automatically.
- **Self-Cleaning of Expansion Valve**  
This function is utilized to clean the expansion valve automatically when the operation stops during cooling operation. The sound of the refrigerant flowing may be heard from the indoor unit during self cleaning operation. However, it is not abnormal.
- **Hot Start During Heating Operation**  
This function is utilized to prevent cold discharged air at start-up of heating operation, after defrosting operation, etc. The fan speed automatically switches from Slow to Low and then to the set fan speed. The fan operation might be stopped for up to 2 minutes. At this time the louver is fixed horizontally.

## NOTE

- This air conditioner is used hot air circulation system for the heating operation. If the air conditioning room is large or the room temperature is excessively low, it takes time to warm the whole room. "HOT-START" will be turned OFF after heating the room.
- "HOT-START" may be displayed during or right after the defrosting operation. It is activated to prevent the cold draft. It is NOT abnormal.

## 12. Simultaneous Operation

The multiple indoor units can be controlled by one wired controller (Single: max. 16 units, Twin: max. 8 sets, Triple: max. 5 sets, Quad: max. 4 sets). Contact a distributor or a contractor for detail.

## 13. Maintenance

### ⚠ WARNING

- Turn OFF the power source before the maintenance work. If not, it may cause a fire or an electric shock.
- Perform the maintenance work with stable footing. If not, it may cause falling or injury.

### ⚠ CAUTION

- When the air inlet grille is opened (closed) or the air filter is attached (removed), perform the work according to this operation manual. If not, it may cause falling or injury.

### 13.1 Daily Maintenance

#### 13.1.1 Cleaning Air Filter

Clean the air filter when the filter sign is turned ON.

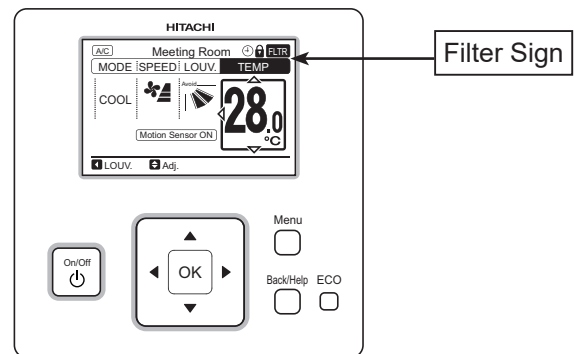

#### (1) Open the air inlet grille.

Press and slide the cover of the air inlet grille in the direction of the arrow with fingers in the holes on the cover.

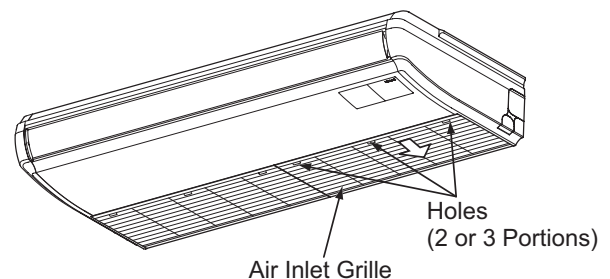

(2) Remove the air filter.

Push the air filter toward arrow direction to unhook it from the air inlet grille, and remove the air filter.

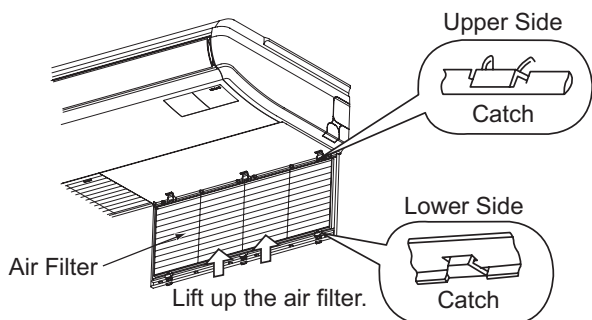

(3) Clean the air filter.

- Vacuum the dust by a cleaner, or wash the air filter by water or neutral detergent.
- Dry the air filter in the shade.  
(It is to prevent the air filter from degradation by ultraviolet.)

---

**NOTE**

---

- Do not use hot water more than 50°C.  
The air filter may be deformed by heat.
- Do not dry the air filter by an open fire, a dryer or a heater. The air filter may be deformed.

(4) Attach the air filter.

After the air filter is dried, attach correctly to the air inlet grille.

(5) Close the air inlet grille.

---

**NOTE**

---

Be sure to attach the air filter.  
If the indoor unit is operated without the air filter, it may cause malfunction of the indoor unit.

---

(6) Reset the filter sign.

---

**NOTE**

---

If the accumulated time of filter cleaning is not got to setting time, the indication "☒" is turned ON and "Setting Disabled" will be displayed.

---

- Press "Menu".  
Select "Reset Filter Sign Time" from the menu and press "OK".  
The confirmation screen will be displayed.

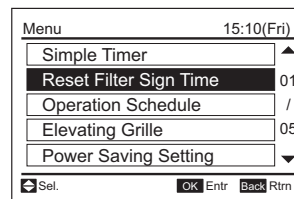

- Select "Yes" by pressing "<" or ">" and press "OK".  
The indication of "FLTR" will be turned OFF and the screen will return to the normal mode.

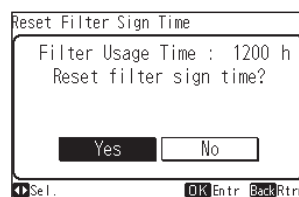

### 13.1.2 Removing, Attaching and Cleaning Air Inlet Grille

Wipe the air inlet grille by a soft cloth which is soaked in lukewarm water and squeezed.

## NOTICE

Use a soft cloth to clean the air inlet grille, the air outlet and the service cover. If benzine, thinner or detergent (with surfactant) is used to clean, the resin part may be changed color or deformed. In addition, pay attention that the parts around the air outlet (louver, guide, etc.) may be damaged if an excessive force is applied.

The air inlet grille can be removed and cleaned.

#### (1) Open the air inlet grille.

Press and slide the cover of the air inlet grille in the direction of the arrow with fingers in the holes on the cover.

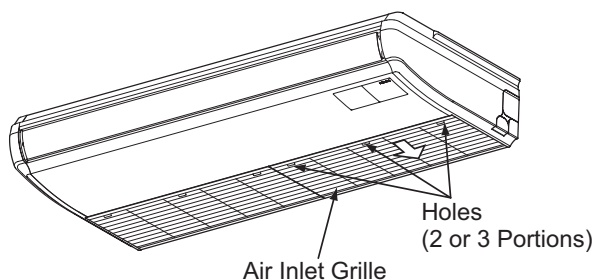

#### (2) Remove the air inlet grille.

- Remove the supporting string from the side plate.

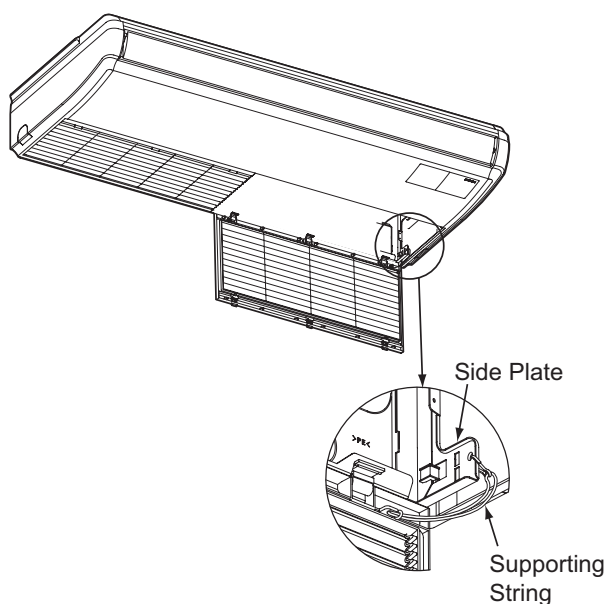

- While the air inlet grille is being opened, depress the knobs of hinge (①), push the air inlet grille toward arrow direction (②) and remove the air inlet grille.

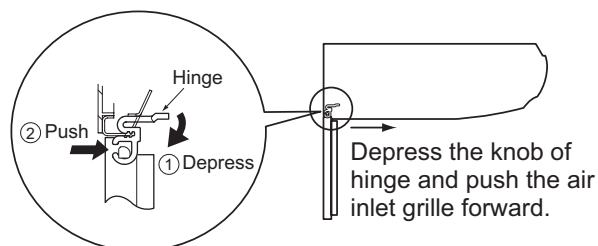

#### (3) Clean the air inlet grille.

#### (4) Attach the air inlet grille.

- Attach the air inlet grille in the reverse procedure for removing.
- The supporting string is attached to the side plate.

### 13.2 Maintenance Beginning and Ending of Use

#### < Beginning of Use >

- Remove obstacles for the air inlet grilles of indoor unit and outdoor unit and the air outlet.

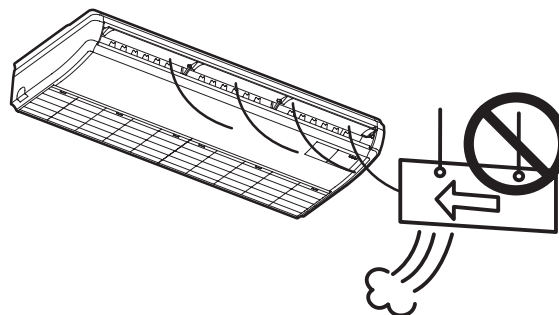

- Check that the air filter is not clogged.

#### < Ending of Use >

- Clean the air filter and the air inlet grille.

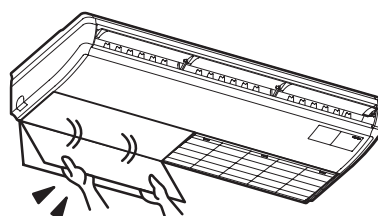



## 14. Troubleshooting

### 14.1 This is Not Abnormal

Phenomenon		Cause and Action
<b>Operation Stopped</b>	All indication lamps on the wired controller are turned OFF.	The micro-computer is activated to protect the device from electromagnetic waves. Restart the operation.
	“Motion Sensor ON” is turned ON on the wired controller.	The operation is stopped automatically because the motion sensor is set as “If absent: OFF” and it detects as absence for a period of time. (All the indoor units connected to the same wired controller are stopped.)
	After Power Failure	Restart the operation. If the instantaneous power failure is within 2 seconds, the operation restarts automatically.
<b>White Steam from Indoor Unit</b>	During Heating Operation	This might occur during the defrosting operation in the heating operation.
<b>White Smoke from Indoor Unit</b>	At Beginning of Heating Operation Season	This might occur when dust attached to the heat exchanger has been dried.
<b>Mist from Indoor Unit</b>	In Restaurant or Kitchen	This might occur when oil attached to the fins might decrease the heat exchange efficiency.
	During Dry Operation	This might occur when the air outlet temperature becomes lower. Change the operation mode.
	During Cooling Operation in Humid Environment	This might occur when the air outlet temperature becomes lower. Raise the set temperature and the air flow volume.
	During FrostWash	This might occur when frost is formed on the fins of the heat exchanger.
<b>Odor from Indoor Unit</b>	Odor Discharged Air from Indoor Unit	This might occur when the smell of cigarette smoke or room stuck to the inside of the indoor unit. Ventilate the unit well in the fan mode and clean the air filter, the air outlet and the air inlet grille.
<b>Sound from Indoor Unit</b>	Grate is heard when starting or stopping the operation.	This is the sound made when the components are rubbing against each other due to the extension and contraction of the resin parts caused by the temperature change.
	Sound of water flowing or bubbling is heard during the operation.	This is the sound made when the refrigerant flows or the drain-up mechanism drains water. The sound may be heard especially when starting the operation or stopping the compressor (for approx. 3 minutes).
	Growling sound may be heard temporarily right after the air flow volume is changed.	It is generated because the fan motor makes temporary sound by change of fan speed.
	Crackling sound or sound of frost melting during FrostWash.	This is the sound of the heat exchanger fins freezing and thawing and the sound of resin parts extension and contraction due to changes in temperature.
<b>Dew Condensation on Indoor Unit</b>	Dew condensation on Air Inlet Grille or Cabinet or Dew Drops	This might occur when the operation is performed in humid place (relative humidity is approx. 80%) for a long time.
	Dew condensation on Air Inlet Grille or Cabinet during or after FrostWash	This might occur when the operation is performed in humid place (relative humidity is approx. 80%) and high temperature place (higher than 30°C).
<b>Temperature Irregularity</b>	The air flow volume and temperature of each air outlet are irregular.	This might occur for structural reasons, such as the size of air outlet and the location of heat exchanger.
<b>“HOT-START” or “Preheating” on LCD Turned ON</b>		This might occur according to the operation mode or operation conditions.
<b>Operation Mode on LCD Flashing</b>		

## 14.2 Before Contact

Check the items before contacting a contractor.

Trouble		Checking Point	Action
<b>Operation Unavailable</b>		Check that the main power source is turned ON.	Turn ON the main power source for the air conditioner.
		Check that the fuse is not blown out or the circuit breaker of main power source is not tripped.	Replace the fuse or reset the circuit breaker. If the trouble recurs, contact your contractor or distributor.
<b>Immediate shutdown after start-up</b>	Cooling	Check that the air inlet and outlet of the outdoor unit are not covered with a paper, a vinyl or other objects.	Remove objects covering the air inlet and outlet.
	Heating	Check that there are any obstacles preventing the air flow near the air inlet and outlet of the outdoor unit.	Remove the obstacles preventing the air flow.
		Check that the outlet air is not short-circuited to the air inlet.	
<b>Insufficient Cooling or Heating</b>		Check that the operation mode is appropriate.	If the fan mode is selected, switch the operation mode to cooling (heating).
		Check that the set temperature is appropriate.	If not, change the set temperature by pressing “Δ” or “▽” by the wired controller.
		Check that the air flow direction is appropriate.	If not, change the air flow direction. In the case that the footing is not heated well during the heating operation, change the louver downward.
		Check that the air filter is not clogged.	Clean the air filter.
		Check that a window and a door are not opened.	Close the window and the door.
		Check that there are any obstacles preventing the air flow near the air inlet and outlet of the indoor and outdoor units.	Remove the obstacles.

### 14.3 Contact Distributor

If the problem is not resolved even after checking the previous items or if other troubles not mentioned in the previous pages occur, stop using the product and contact your distributor or contractor.

## ! WARNING

**If abnormality (burnt odor, etc.) occurs, stop the operation and turn OFF the main power source immediately. If not, it may cause breakage of the product, an electric shock or a fire. Contact your distributor or contractor.**

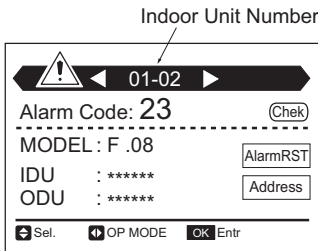
Trouble	Action before Contact
Protection devices (fuses, breakers, and ELB's) activate frequently or the operation switch does not work.	Turn OFF the power supply.
Water leakage from the indoor unit.	Stop the operation.
"Motion Sensor ON" is flashing.	There is a possibility of the failure of motion sensor. Make the setting of motion sensor and "Floor HEAT Control" invalid and contact your distributor. In that case, after the LCD of wired controller display has disappeared and until service is finished, the operation of this unit is available.
<ul style="list-style-type: none"> <li>● The RUN indicator (red) is flashing.</li> <li>● The indoor unit number, alarm code, unit model code, and the number of connected indoor units are displayed on LCD.</li> <li>● If multiple indoor units are connected to one controller, the above abnormality informations for each indoor unit are displayed individually.</li> </ul> <p>Check the details on LCD and contact your distributor.</p> <div style="text-align: center;">  </div>	<p>Refer to the item 14.4, the alarm code table. Contact your distributor and inform them of the alarm code indicated on the LCD of the wired controller.</p>

**Provide the following information when contacting your distributor.**

- 1) Unit Model**
- 2) Content of Trouble**
- 3) Alarm Code No. on LCD or Details of a Flashing Indicator**

## 14.4 Alarm Code

Code	Category	Content of Abnormality	Code	Category	Content of Abnormality
01	Indoor Unit	Activation of Protection Device (Float Switch)	35	System	Incorrect Setting of Indoor Unit No.
02	Outdoor Unit	Activation of Protection Device (High Pressure Cut)	36		Incorrect Indoor Unit Combination
03	Transmission	Transmission Failure between Indoor and Outdoor	38		Abnormality of Picking up Circuit for Protection in Outdoor Unit
04		Transmission Failure between Inverter PCB and Outdoor PCB	39	Compressor	Abnormality Running Current at Constant Speed Compressor
05	Supply Phase	Abnormality Power Source Phases	41	Pressure	Overload Cooling
06	Voltage	Abnormality of Voltage Drop in Outdoor Unit	42		Overload Heating
07	Cycle	Decrease in Discharge Gas Superheat	43	Protection Device	Activation of Pressure Ratio Decrease Protection Device
08		Excessively High Discharge Gas Temperature at Top of Compressor Chamber	44		Activation of Low Pressure Decrease Protection Device
09	Outdoor Unit	Activation of Protection Device for Outdoor Fan	45		Activation of Low Pressure Increase Protection Device
11	Sensor on Indoor Unit	Inlet Air Thermistor Failure	46		Activation of High Pressure Increase Protection Device
12		Outlet Air Thermistor Failure	47		Activation of High Pressure Decrease Protection Device
13		Freeze Protection Thermistor Failure	48	Activation of Overcurrent Protection Device	
14		Gas Piping Thermistor Failure	51	Inverter	Abnormal Inverter Current Sensor
19	Fan Motor	Activation of Protection Device for Indoor Fan	52		Activation of Inverter Overcurrent Protection
20	Sensor on Outdoor Unit	Compressor Thermistor Failure	53		Activation of Transistor Module Protection
21		High Pressure Sensor Failure	54	Abnormality of Inverter Fin Temperature	
22		Outdoor Air Thermistor Failure	56	Outdoor Fan	Abnormality of Detection for Fan Motor Position
23		Discharge Gas Thermistor Failure	57		Activation of Fan Controller Protection
24		Evaporating Thermistor Failure	58	Abnormality of Fan Controller	
29		Low Pressure Sensor Failure	b0	System	Incorrect Setting of Unit Model
31	System	Incorrect Capacity Setting of Outdoor Unit and Indoor Unit	b1		Incorrect Setting of Unit and Refrigerant Cycle No.
32			Incorrect Setting of Other Indoor Unit Number	EE	Compressor

**The End**