

# OPA 1410/1710/2110 RLTM1FPQ(-Z) (Econex) Air Cooled Packaged Units - Reverse Cycle - R32 Installation & Maintenance

CONTENTS	Page
1. GENERAL .....	1
2. INSTALLATION .....	2
3. REFRIGERATION SYSTEM.....	2
4. WIRING .....	3
5. ECONOMISER.....	4
6. SPILL AIR .....	4
7. START-UP PROCEDURE .....	5
8. OPERATION .....	5
9. MAINTENANCE .....	5
10. TROUBLESHOOTING .....	6
11. WARRANTY .....	6
APPENDIX I : UC8 PROTECTION FUNCTIONS.....	7
APPENDIX II: AIR HANDLING PERFORMANCE.....	9
COMMISSIONING CHECK LIST .....	10

---

## 1. GENERAL

Temperzone OPA Outdoor Air Cooled Packaged units.

Follow these instructions to ensure the optimum performance, reliability and durability.

Units must be installed in accordance with all national and regional regulations and bylaws. National Health and Safety regulations must be followed to avoid personal injuries.

The appropriate local permits must be acquired and adhered to.

Local regulations on maximum boundary noise need to be considered when positioning the unit.

The accompanying 'R32 Handling Ducted Packaged Units' pamphlet forms part of these Installation & Maintenance instructions.

### ⚠ WARNING

**These units use R32 refrigerant (Class A2L) which is mildly flammable.**

The unit shall be installed, operated and stored in a well ventilated space. If the refrigerant gas comes into contact with fire, a poisonous gas may occur. Be aware that R32 does not contain an odour.

If indoors, the appliance shall be stored in a room away from continuously operating sources known to cause ignition of R32 refrigerant (for example an operating gas appliance or operating electric heater)

---

## 2. INSTALLATION

### 2.1 Clearances & Service Access

Refer to Specification Sheet supplied for minimum clearances. If multiple units are to be placed side-by-side then allow at least 2m between coil faces.

Filter slides are fitted within the unit. Access to the filter access door should be considered when designing return and supply air ductwork.

### 2.2 Pallet Removal

Prior to mounting the unit, remove all wooden pallets from beneath the mounting rails, by first temporarily removing the drain troughs (either side of unit) to gain access to the pallet screws. Replace the troughs when finished.

### 2.3 Mounting

The unit should be fastened to a firm flat horizontal base using the holes supplied in the mounting channels. When the unit is being installed on a roof it is recommended that the unit is installed on a substantial structure with vibration isolating pads or mounts. If placed on the ground or concrete pad, use rubber pads or mounts to give 20mm min. ground clearance.

Flexible duct connections are recommended between the supply and return ducts and the unit.

The unit is shipped with plastic wedges installed under the compressors. Ensure these wedges are removed from the compressor feet prior to starting the unit (not required for operation).

### 2.4 Economiser/Fresh Air Cowl Option

The Economiser cowl is supplied separately and must be fitted to the unit – usually after the unit is lifted in to place. Screws and pre-drilled holes are provided. Ensure the top of the cowl is tucked under the roof lip of the air conditioner and that all joints are sealed with silicon sealant. There must be at least 300mm clearance beneath the cowl once it is fitted in place.

### 2.5 Spill Air Cowl Option

The Spill Air cowl is supplied separately and must be fitted to the unit – usually after the unit is lifted in to place. Fit below the Economiser cowl. Screws and pre-drilled holes are provided.

### 2.6 Condensate Drains

The condensate drains should be ‘U’ trapped outside the unit. The traps should have a vertical height of at least 100 mm. The drain lines should have a slope of at least 1 in 50 and must not be piped to a level above the unit drain pipe.

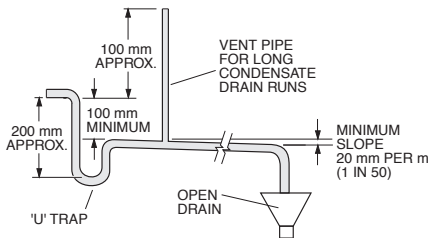

## 3. REFRIGERATION SYSTEM

### 3.1 General

Each OPA 1410/1710/2110 has four refrigeration systems – one with a variable speed inverter compressor; the remaining three are fixed speed compressors.

Each refrigeration system has been charged with R32 refrigerant; refer Specifications document for amount.

### 3.2 Compressors

The compressors are inverter and fixed speed scroll type. The compressor lubricant is POE-46 (NXG5020 or equivalent). Note, this oil absorbs moisture quickly if exposed to open air.

## 4. WIRING

### 4.1 Electrical Requirements

Electrical work must be done by a qualified electrician and meet standard AS/NZS 3000.

**⚠ DANGER! LIVE ELECTRICAL CONNECTIONS. ISOLATE MAINS POWER BEFORE WORKING ON UNIT. ONLY QUALIFIED PERSONS WHO ARE COMPETENTLY TRAINED SHOULD PERFORM SERVICE AND MAINTENANCE TASKS.**

The unit must be wired directly from a distribution board using an appropriately sized circuit breaker. The termination point for the mains cable is in the electrical compartment. An isolating switch is required, near but not on the unit.

A hole for power cable entry is provided bottom right-hand corner, next to the compressor access door. From there route the cable into the electrical box via the hole on the bottom of the electrical box or through the hole on the RH side of the electrical box.

### 4.2 Control options

OPA Econex units can be controlled using any of the following options:

- TZT-100 wall thermostat
- 24V AC and 0-10V signals from an external controller or thermostat
- Remote on/off switch and/or time clock
- Modbus RTU serial communications over RS485 connection
- BACnet-IP serial communications over Ethernet connection (with optional gateway module)

Standard reverse cycle units are suitable for use with thermostats and controls with manual heating/cooling selection or automatic change-over.

A unit wiring diagram is supplied alongside the electrical board and in the Specifications document.

### 4.3 TZT-100 wall thermostat

To connect the thermostat to the unit it is recommended to use shielded twisted pair type cable, suitable for RS485 communications. Signals A and B should form one twisted pair.

**Note:** The cable shield should connect to terminal ‘0V’ on the UC8 controller only. Do not connect at both ends.

Connect the thermostat as follows:

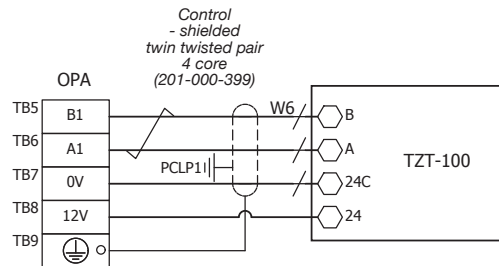

**Note: Capacity Staging.** A TZT-100 must be configured for single-stage operation, **the default setting.**

TZT-100 has its own DIP switches that must be set as follows:

<b>DIP switch 2</b>	ON	Equipment type = Heat Pump
<b>DIP switch 3</b>	OFF	Equipment stages = One
<b>DIP switch 4</b>	ON	Reverse cycle valve on = Heating

### 4.4 Communications format for TZT-100

Communications format must be set as per recommended Modbus RTU:

- Baud rate (bd or br) 19200
- Data bits 8
- Parity Even
- Stop bits (Pa) 1
- TZT-100 address (Ad) 7

The procedure to check and adjust these settings is:

1. Press and hold the O/RIDE button until the display shows the PIN
2. Use the UP & DOWN buttons to select PIN code 88:21, then press O/RIDE in installer mode.
3. Use the O/RIDE and PROG buttons to cycle through the various installer settings.

If necessary, refer TZT-100 User Manual for more detail.

### 4.5 Remote on/off

The UC8 has an input for a remote on/off function on terminal ‘On’, signal return is terminal ‘0V’. When used, the remote on/off terminals should connect to a voltage-free relay contact. When not used, the remote on/off terminals should be shorted (‘bridged’).

#### 4.6 Capacity control

OPA Econex units offer the following capacity control options:

- Automatic control when the unit connects to the TZT-100 wall thermostat.
- 24VAC fixed and 0-10V inverter compressor control signals
- 0-10V indoor fan control signal.
- Control by a building management system via Modbus RTU or BACnet/IP serial communications.

#### 4.7 Unit Controller (UC8)

The unit's UC8 controller receives requests such as 'Unit On/Off', 'Start compressors', 'Activate HEAT (Reverse Cycle)' and transfer the requests to the outputs after enforcing safety timers.

Figure 4. UC8 Controller

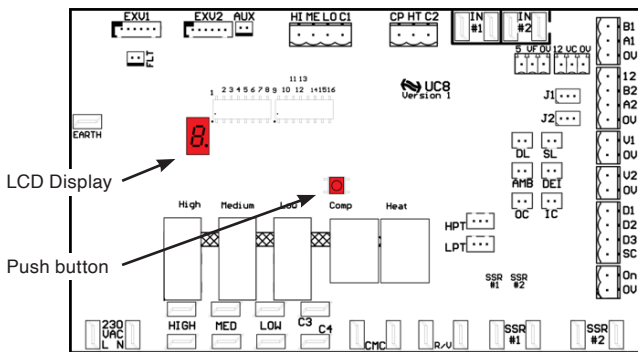

The Unit Controller provides several system protection functions. These are covered in Appendix I (p.9).

For additional information, refer to the UC8 Controller label on the unit or [www.temperzone.biz](http://www.temperzone.biz) for operation & fault diagnostics information; model search 'UC8'.

References available:

- UC8 Operation Manual : Air-to-Air Units
- UC8 Fault & Display Messages (as per unit label)
- UC8 Quick Reference and Operation Fault Diagnosis
- UC8 Troubleshooting Guide
- UC8 Modbus Communications
- UC8 BACnet Communications
- UC8 Master-Slave Connection

#### 4.8 Control using switched and 0-10V signals

An external controller that provides 12/24V ac/dc switched signals or has a set of voltage-free relay contacts should be connected as per the diagram below. If no fan/compressor capacity control signals, then link UC8 terminals 'VF' and '5' and 'VC' and '12'.

Figure 5. BMS connection

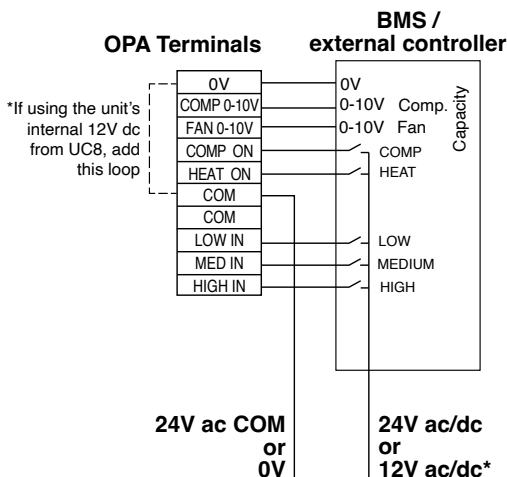

#### 4.9 Control via Modbus RTU communications

OPA Econex units can be fully monitored and controlled via Modbus RTU serial communications.

The following is typical for most installations:

- Set DIP switches 11 and 12 to OFF on all UC8 controllers.
- Connect BMS terminal A / TX+ to terminal A1 on the UC8 controller via terminal block shown.
- Connect BMS terminal B / TX- to terminal B1 on the UC8 controller via terminal block shown.

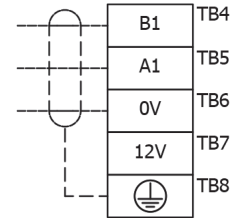

Connect cable screen to 'EARTH' terminal

Multiple OPA units can be daisy-chained together. For detailed information about monitoring and control via Modbus RTU refer to document 'UC8 Modbus communications', available at [www.temperzone.biz](http://www.temperzone.biz) (model search 'UC8') or [temperzone.com](http://temperzone.com) website.

#### 4.10 Setting the UC8 Modbus device address

To view or change the Modbus device address of a UC8 follow these steps:

- Power up the unit but leave the compressors off.
- Hold down the SW3 pushbutton on the UC8 circuit board until the display shows:  
'0' [release] → '1' → short press to '2,' [long press] → A, [long press]
- The display will show the current Modbus device address. The factory default address is '44'. [Short press] the button to select higher numbers, for example press once to change the address to 45, press twice for address 46 and so forth. [Long press] to save the chosen address. After address 99 the number returns back to 1.
- The controller returns to the default state (– ●).

#### 4.11 BMS – BACnet

A BACnet connection is available using Babel Buster 3. For information regarding using BACnet commands, please ask Temperzone.

### 5. ECONOMISER OPTION

The Economiser package that is factory fitted consists of two opposed blade dampers, one for the fresh air and the other for the return air and complete with individual damper motors controllable from a 0 – 10V dc signal. The package also includes a fresh air cowl (weatherhood) assembly that is supplied as a separate item for fitting on site.

It is important that the installation instructions for the fitting of the fresh air cowl are followed otherwise it is possible some water ingress from rain could occur. The top flange of the cowl must be tucked under the top panel lip.

The damper control will be factory wired such that the return air damper will close proportionally as the fresh air damper opens proportionally and vice versa. The fresh air damper's adjustable stop can be set such that it does not close 100%; many installations may require a minimum fresh air introduction of 10 – 15% and the stop may be set on site to facilitate this. Set the economiser Fresh Air Damper motor 'stop' to the equivalent negative static pressure as with

F/A damper closed. This is to ensure the air flow volume remains constant and does not dramatically increase when introducing fresh air. Failure to set the correct 'stop' position could result in rain/moisture entrainment in the incoming fresh air resulting in water deposited inside the unit.

As previously mentioned a 0 – 10V dc control signal is required to drive the dampers open and closed. This could be from a BMS or a temperature/humidity controller.

It is recommended that control is by Enthalpy (or by a combination of dry and wet bulb temperatures) so that free cooling is used without adding any heat load to the building. Control by dry bulb temperature alone is not recommended as often, even though the outdoor dry bulb temperature may be lower than that of the space, the total heat content of the air can be higher thereby adding heat load in the form of moisture content to the space.

If dry bulb temperature is used as the control method the temperature must be set several degrees lower than the space temperature to reduce the possibility of extra heat load being introduced.

An Air Quality (CO<sub>2</sub>) sensor (supplied by others) can be used to proportionally control the fresh and return air dampers (via the control system).

In all situations the UC8 Unit Controller will allow the compressors to operate with the economiser fresh air damper open providing the refrigeration system is not compromised.

The compressor(s) could be stopped from operating by normal protection devices such as low suction temperature/pressure or indoor coil frost protection and too many trips of either fault could lead to a lock out of the compressor(s) operation. Should this occur then a review of the control settings may be necessary.

---

## 5. SPILL AIR OPTION

The Spill Air package, that is factory fitted, consists of an opposed blade damper for exhaust air and comes complete with a damper motor. The package also includes a spill air cowl (weatherhood) assembly that is usually supplied as a separate item for fitting on site.

The Spill Air package is used to prevent over-pressurisation of the building during periods of fresh air introduction

The Spill Air damper is controlled by a 0-10V BACnet signal in sync with the fresh air inlet damper and the return air damper.

---

## 6. START-UP PROCEDURE

### 6.1 Before starting the compressor

1. Before working on the unit remove mains power from the unit by opening the mains isolating switch.
2. Remove the shipping wedges from beneath each compressor. Check that each compressor is securely mounted.
3. Check the thermostat and/or other controls are correctly wired to the unit.
4. Check tightness of electrical connections.
5. Check air filters have been correctly installed. (Filters must be installed before starting the unit.)
6. Check that all indoor fan motors can freely rotate.
7. Apply mains power to the unit by closing the mains isolating switch.
8. Check the supply voltage between each phase and neutral.
9. Air balance the building's ducting system.

10. Before starting the compressors a four hour delay period is required to allow the crankcase heaters to drive any liquid refrigerant out of the compressor oil. Mains power must be switched on during this four hour delay period.

### 6.2 Commissioning

After the four hour delay period has expired (see step 10 in section 6.1) complete the following procedure. You can use the Commissioning Sheet (refer back page) to help you.

1. Place the UC8 controller in commissioning mode by pressing and holding the SW3 push button (see Fig. 4) until the display shows:  
'0' [release] → '1' [long press] → 't'; [short press] repeat to find 'c', then [long press] to select.



This Commissioning mode 'c' reduces the waiting times at start-up and between cycles for the next half hour, or until the controller is reset by removing power.

2. Start compressor in Cooling mode.

3. Check the outdoor fan motor runs smoothly.

*Note: The outdoor fan does not necessarily start rotating immediately after the compressor is started. The fans may run-on for a short period after the compressor stops.*

Outdoor fan stops during outdoor coil de-ice cycles.

4. Measure the current draw on each phase to the compressor motor and to each fan motor. Check the readings against the specified values in the wiring diagram or specification sheet.

5. The display and pushbutton on the UC8 can be used to check temperatures and pressures. Short presses on the pushbutton cycles through the available options. **Table 1** on page 9 shows, in sequence, what information is available – with examples.

Alternatively use a set of pressure gauges suitable for R32 refrigerant.

#### **⚠ WARNING**

Under no circumstances shall potential sources of ignition be used in the searching for or detection of refrigerant leaks. If a leak is suspected, all naked flames shall be removed/extinguished.

If a leakage of refrigerant is found which requires brazing, all of the refrigerant shall be recovered from the system, or isolated (by means of shut-off valves) in a part of the system remote from the leak.

6. Repeat steps 2 to 5 for each compressor.
7. Test operation of the compressors when operating in heating mode.
8. Check for desired supply air flow rate at each outlet.
9. Touch up any outdoor unit paintwork damage to prevent corrosion.
10. Sign the check label.

### 6.3 Commissioning of variable speed (EC) indoor plug fan

A unit equipped with variable speed (EC) indoor plug fans allows adjustment of the fan speeds to obtain the desired indoor supply airflows.

#### Using TZT-100 option

If the unit is controlled with a temperzone TZT-100 wall thermostat then adjustments are made as follows:

- i. Ensure the compressor is off and the thermostat or BMS does not request for the compressor to start. The UC8 display should show a flashing dot (●).
- ii. To adjust the fan High speed press and hold down the SW3 push button on the UC8 circuit board until the display shows:  
'0' [release] → '1' [long press] → 't'; [short press] repeat

to find 'H', then [long press] to select.

- iii. The fan will start and run at High speed. The display shows the fan control voltage for the High speed setting; factory default value is 8.0V. 
- iv. Each following press on the SW3 push button increases the indoor fan control voltage in steps of 0.5V, up to a maximum of 10.0V. Pressing the push button again when value 10.0 is shown returns the fan control voltage down to the minimum value of 3.0V and back up again.
- v. When the desired setting for high fan speed is displayed, [long press] to select and save. The controller then exits the menu and the fan stops.
- vi. To adjust the fan Low speed hold down the SW3 push button on the circuit board until the display shows: '0' [release] → '1' [long press] → 't'; [short press] repeat to find 'L', then [long press] to select. The fan will start and run at the Low speed setting. The factory default value is 5.0V.
- vii. Repeat steps (iv) and (v) to adjust the fan Low speed setting. The minimum control voltage for Low speed is 1V and the maximum control voltage for Low speed is 8V. (Note: A 'low' control voltage of less than 2V is not recommended.) If 'low' is set higher than 'high', the 'high' is made equal to 'low'.
- viii. Check if the High speed airflow is to specification (refer Note below)

#### Using Alternative Thermostats

Follow same procedure as for TZT-100.

#### Note:

*If fan speed selections are different from the factory default values then the procedure above must be carried out for the UC8 controller in the unit.*

*It is allowed to make the control voltages for low and high fan speed equal. This makes the indoor fan act as a fixed speed fan.*

*It is allowed to control the indoor fan speed by an external source, independent of the UC8 controller. It is then the responsibility of the system-designer and installer to ensure proper and safe operation of the indoor fan, and the system as a whole, under all operating conditions.*

*Setting the indoor fan speed too low can bring risk of frost forming on the indoor coil with potential nuisance frost protection trips on cooling, possibly even unit lock-out, and/or HP trips on heating.*

*Setting the indoor fan speed too high can bring a risk of any condensation being sucked off the fins of the indoor coil off the fins of the indoor coil and into the supply air duct. Water could then start leaking from the supply air vents and diffusers and corrosion of ducting may occur.*

*Setting the indoor fan speed too high can also bring a risk of 'over-condensing' (when the unit is heating) which in turn could cause the unit to perform more outdoor coil de-ice cycles than necessary.*

*Refer Appendix II Air Handling graphs for min./max. airflows.*

## 7. OPERATION

### 7.1 Safety timers

The UC8 receives control signals and transfers the signals to the outputs after enforcing safety timers and other protection functions. If the compressor is held off, or held on, by a safety timer then the display shows message 'H-O-L-d'.

Normal durations of safety timers are:

- Minimum off time 3 minutes
- Minimum run time 1.5 minutes
- Min. cycle time 6 minutes (up to 10 compressor starts per hour)
- Min. mode change-over time 10 minutes (cooling to heating or vice-versa)

### 7.2 Variable Capacity

The OPA unit is equipped with a single variable capacity compressor (inverter scroll type) and three fixed capacity compressors. The inverter compressor operating capacity is 16%–100% using 1.6V–10V control voltages. Fixed speed compressors operate at 100%.

At any time, when operating conditions dictate, system protection functions can restrict unit operating capacity.

When a capacity signal is presented that is lower than the minimum capacity (for example 0V on input 'VC') then the compressor operates on minimum duty.

If a unit operates on low capacity for extended periods then the unit may periodically perform oil flush cycles. Under such operating conditions compressor lubricating oil may slowly settle in parts of the refrigeration system other than the compressor. Oil flush cycles help to return the lubricating oil to the compressor. During an oil flush cycle compressor speed is increased for a duration of 1 minute.

**Variable capacity indoor air fan – Refer Section 6.3**

#### Note:

*Setting the indoor fan speed too low can bring risk of frost forming on the indoor coil with potential nuisance frost protection trips on cooling, possibly even unit lock-out, and/or HP trips on heating.*

*Setting the indoor fan speed too high can bring a risk of blowing moisture off the fins of the indoor coil and into the supply air duct. Water could then start leaking from the supply air grilles and corrosion of ducting may occur.*

*Setting the indoor fan speed too high can also bring a risk of 'over-condensing' (when the unit is heating) which in turn could cause the unit to perform more outdoor coil de-ice cycles than necessary.*

*Refer Appendix II for indoor airflow range.*

*Outdoor fans do not necessarily start rotating immediately after the compressor is started. The fans may run-on for a short period after the compressor stops.*

*The indoor fan will reduce speed if in heating mode and the condensing temperature is too low to automatically allow the condenser coil to warm up. The fan speed may also slightly reduce when in Latent Cooling mode, if this option is enabled.*

## 8. MAINTENANCE

**⚠ WARNING! HAZARDOUS VOLTAGE. ENSURE ALL POWER SUPPLIES ARE ISOLATED BEFORE PERFORMING MAINTENANCE. FAILURE TO ISOLATE POWER CAN LEAD TO SERIOUS INJURY.**

### 8.1 Monthly

1. Check air filters and vacuum, wash clean or replace as necessary.
2. Check condensate drain for free drainage.
3. Check compressor compartment for oil stains indicating refrigerant leaks.

#### **⚠ WARNING**

Under no circumstances shall potential sources of ignition be used in the searching for or detection of refrigerant leaks. If a leak is suspected, all naked flames shall be removed/extinguished.

If a leakage of refrigerant is found which requires brazing, all of the refrigerant shall be recovered from the system.

4. Check system operating pressures via each UC8 controller or using a Temperzone Wifi Service Utility (WSU); pn 201-000-700; refer Appendix I.

### 8.2 Six Monthly

1. Check the tightness of electrical connections.
2. Check for signs of corrosion on electrical connections in high salt atmospheres; replace where necessary.
3. Check the tightness of all fan motor mountings
4. Check system operating pressures via each UC8 controller or using a Temperzone Wifi Service Utility (WSU); refer Appendix I.
5. Check condensate drain for free drainage.

### 8.3 Yearly

1. Check all refrigerant piping for chafing and vibration.
2. Check air supply at all diffusers
3. Check for excessive noise and vibration and correct as necessary.
4. Check for insulation and duct damage and repair as necessary.
5. Check system operating pressures via each UC8 controller, or using a Temperzone Wifi Service Utility (WSU); refer Appendix I.
7. Remove lint and dust accumulation from outdoor coil fins with soft brush or low pressure water spray. In corrosive environments, the checking and cleaning frequency should be increased.
8. Touch up any paintwork damage to prevent corrosion.

## 9. TROUBLESHOOTING

### 9.1 Room temperature varies significantly from its setting

- Unit may have been incorrectly sized for the building.
- Drafts from wrongly placed supply air diffusers or from the back of the wall plaque could be affecting the temperature sensor built into the wall plaque.
- Poor air circulation in the room can cause incorrect temperature readings.

### 9.2 Air conditioner does not seem to deliver the heating when most needed

- Heating capacity at design conditions may be incorrect. As the outside temperature falls, heat losses through the walls, floor and ceiling increase.
- Check the unit's brochure for information on the minimum/maximum operating temperatures.
- When heating, units have de-icing cycles built-in to remove ice on the outdoor coils. This usually means reversing the cycle on some, but not all systems at once, for a few minutes. Heating may be slightly reduced at this time, but usually not noticeable.

### 9.3 In a new building, why does it take some days before the air conditioning heat pump unit seems to work properly

- Many new buildings, especially a commercial buildings, have a large amount of concrete and other structural materials that are generally cold and full of moisture. This is most evident in winter when trying to heat the building from outdoor ambient condition, ie a Cold Start.

### 9.4 Unit is leaking water

- Check the drain trap/vent/slope.
- Water carry-over: Reduce the maximum fan speed. Refer Appendix II for indoor airflow range.
- Check fresh air damper is not opened by BMS when raining outside

# APPENDIX I

## UC8 PROTECTION FUNCTIONS

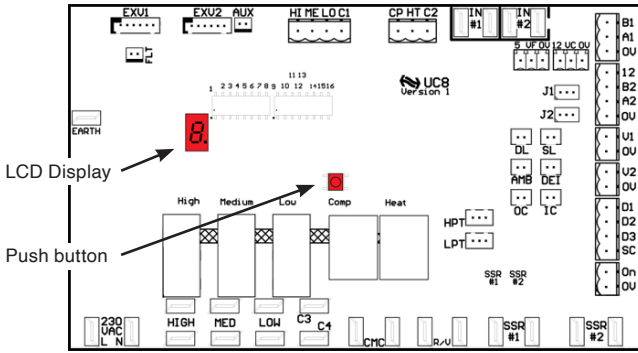

Each OPA Econex unit utilises up to four UC8 Controllers, one for each refrigeration system. The UC8 controllers receive requests from the Master Controller such as 'Unit On/Off', 'Start compressors', 'Activate HEAT (Reverse Cycle)' and transfer the requests to the outputs after enforcing safety timers.

Each UC8 implements system protection functions such as indoor coil frost, extreme high and low pressures, rapid on-off cycling of the compressors, loss of refrigerant and more.

The following applies to all protection functions except where otherwise indicated:

Unit operating capacity may automatically be reduced before a protection function is activated. Such a reduction may be sufficient to prevent an actual trip from occurring.

When a compressor is stopped by a protection function it is held off for a period of 3 minutes, after which it is allowed to restart (provided the cause of the trip has cleared).

When a protection function is active and when a unit is locked out the alarm relay output "FLT" is active.

For more information about protection functions and troubleshooting, refer to document "UC8 Troubleshooting", available at [www.temperzone.biz](http://www.temperzone.biz) website; model search 'UC8'.

### 1 High pressure protection (HP)

OPA Econex units are fitted with high pressure transducers connected to UC8 input HPT. A compressor is switched off when the discharge line pressure reading exceeds approx. 4350 kPa.

The display shows the letters 'HP' when protection is active.



### 2 Low pressure protection (LP)

OPA Econex units are fitted with low pressure transducers connected to UC8 input LPT. A compressor is switched off when the suction line pressure reading falls below 130 kPa (inverter) / 140 kPa (fixed speed).

The display shows the letters 'LP' when protection is active.



### 3 Indoor coil frost protection

When the unit is cooling the evaporating temperature in the indoor coil should remain above -8°C. If this temperature falls below -8°C then ice (frost) likely will form on the indoor coil. If the low temperature persists for longer than 6 minutes then the protection function activates.

When indoor coil frost protection is activated the compressor is stopped for 6 minutes, after which it is allowed to restart.



### 4 High discharge line temperature protection

The controller monitors the compressor discharge line temperature via a sensor connected to input 'DL' (red wires). The compressor is stopped when:

- The temperature rises above 115°C for longer than 15 minutes.
- The temperature rises above 125°C (immediate action).

The display shows the message 'Hi-t' when protection is active.



### 5 High discharge superheat protection

Discharge superheat is defined as the difference between the compressor discharge gas temperature and the condensing temperature. When this temperature differential becomes very high it is an indication that the compressor is being starved of refrigerant gas. Common reasons for this could be a lack of refrigerant (under-charged or loss-of-charge) or a problem with the expansion device (for example a stuck accumulator or loose wiring to an EEV).

The protection is activated when R32 discharge superheat exceeds 60K for longer than 30 minutes.

The display shows the message 'Hi-dSH' when protection is active.



### 6 Low discharge superheat protection

Discharge superheat is defined as the difference between the compressor discharge gas temperature and the condensing temperature. When this temperature differential stays very low it can be an indication that the compressor is being flooded with liquid refrigerant. Common reasons for this could be an excess of refrigerant (over-charged) or a problem with the expansion device (for example a stuck accumulator or loose wiring to an EEV).

The protection is activated when discharge superheat remains below the threshold for longer than 15 minutes. The threshold varies linearly from 0K at standard mode minimum capacity (40%) to 10K at nominal capacity (100%).

This protection function is disabled when a compressor operates at less than standard mode minimum capacity (< 40%).

The threshold for a variable speed compressor operated in boost mode (capacity above 100%) is fixed at 10K.

The display shows the message 'LO-dSH' when protection is active.



### 7 High evaporation temperature / high suction line temperature protection

When the unit has a low pressure transducer connected to the compressor suction line then the controller calculates the evaporating temperature from the suction line pressure reading. If the unit does not have a low pressure transducer then the controller finds the evaporating temperature via a coil temperature sensor (input IC when the unit is cooling, input OC when the unit is heating, yellow wires). Additionally the controller monitors the compressor suction line temperature via a sensor connected to input 'SL' (white wires).

The protection function stops the compressor when:

- The evaporating temperature remains above 27.5°C for longer than 15 minutes.
- The suction line temperature remains above 30°C for longer than 15 minutes.

The display shows the message 'Hi-SL' when protection is active.



## 8 Other alarms

The Master Controller performs many other protection functions. For example:

- Signals from sensors and transducers must remain inside normal operating range.
- Modbus RTU communications with *Carel c.pCO* and *Carel Power+* inverter) must continue uninterrupted.
- Modbus RTU communications with a controller such as a BMS that is controlling the unit must continue uninterrupted.

Refer to document 'UC8 Troubleshooting Guide' for details.

## 9 Lock-out

Each protection function has a trip counter. A trip counter is reset to 0 whenever the compressor run request is removed. Any trip that has occurred more than 12 hours ago is removed from the trip count. For some protection functions, when the trip counter reaches value 3 (i.e. three consecutive trips occur) then the unit is "locked out".

When a unit is locked out the compressor is not allowed to start. Lock-out is designed to protect the compressor from repeatedly starting when a serious fault exists that requires the attention of a service technician.

The display shows the code of the fault that caused the lock-out condition.

A unit that is locked out can be unlocked using any one of the following methods:

- Remove mains power from the unit for at least 3 seconds, then restore power.
- Issue an 'unlock' command via Modbus RTU serial communications.
- Reset the controller via Modbus RTU serial communications.

## 10 Safety timers

Each UC8 slave controller receives control signals and transfers the signals to the outputs after enforcing safety timers and other protection functions. If the compressor is held off, or held on, by a safety timer then the display shows message 'H-O-L-d'.



Normal durations of safety timers are:













- Minimum off time 3 minutes
- Minimum run time 1.5 minutes
- Min. cycle time 6 minutes (up to 10 compressor starts per hour)
- Min. mode change-over time 10 minutes (cooling to heating or vice-versa)

Note:

*If a unit operates on low capacity for extended periods then the unit may periodically perform oil flush cycles. Under such operating conditions compressor lubricating oil may slowly settle in parts of the refrigeration system other than the compressor; oil flush cycles help to return the lubricating oil to the compressor. During an oil flush cycle compressor capacity is increased to a certain minimum. The duration of an oil flush cycle is 1 minute.*



**Table 1**, Information available on the UC8 display.

Item	Unit	Abbreviation	Examples
Compressor suction line pressure	kPa	SLP	 Suction line pressure 1034 kPa
Evaporating temperature	°C	Et	 Evaporating temperature 12°C
Compressor suction line temperature	°C	SLt	 Suction line temperature 18°C
Compressor suction side superheat	K	SSH	 Suction side superheat 6K
Compressor discharge line pressure	kPa	dLP	 Discharge line pressure 2447 kPa
Condensing temperature	°C	Ct	 Condensing temperature 42 °C
Compressor discharge line temperature	°C	dLt	 Discharge line temperature 70°C
Compressor discharge side superheat	K	dSH	 Discharge side superheat 28K
De-ice sensor temperature (located on fins of the outdoor coil)	°C	ICEt	 De-ice sensor temperature 39°C
Capacity	%	CAP	 Capacity 100%
Expansion valve 1 opening	%	EE1	 Expansion valve 1 75% open
Expansion valve 2 opening	%	EE2	 Expansion valve 2 75% open

## APPENDIX II

### AIR HANDLING PERFORMANCE

**Note:** Airflows are for a dry coil. Refer Airflow Selection below.  
As filters thickness varies, the fan air flows given are for units installed without filters.  
No allowance for Reheat coil option.

#### OPA 1410RLTMFPQ

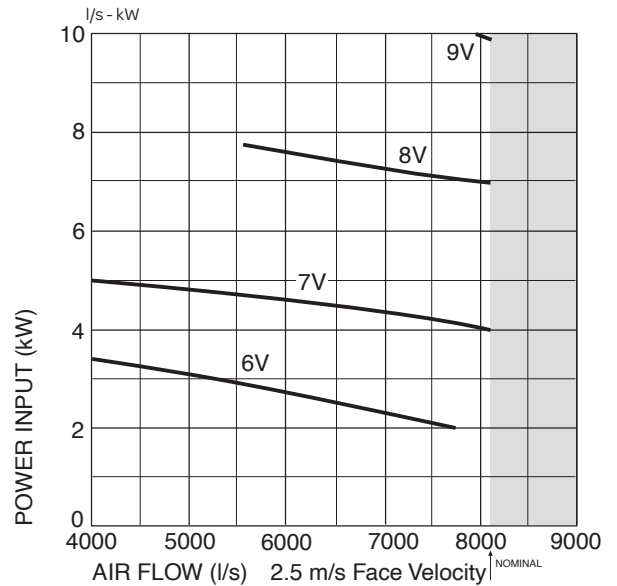
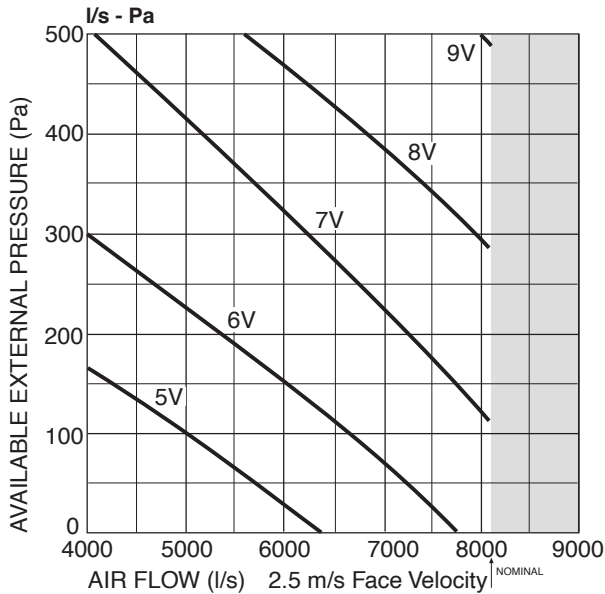

#### OPA 2110RLTMFPQ

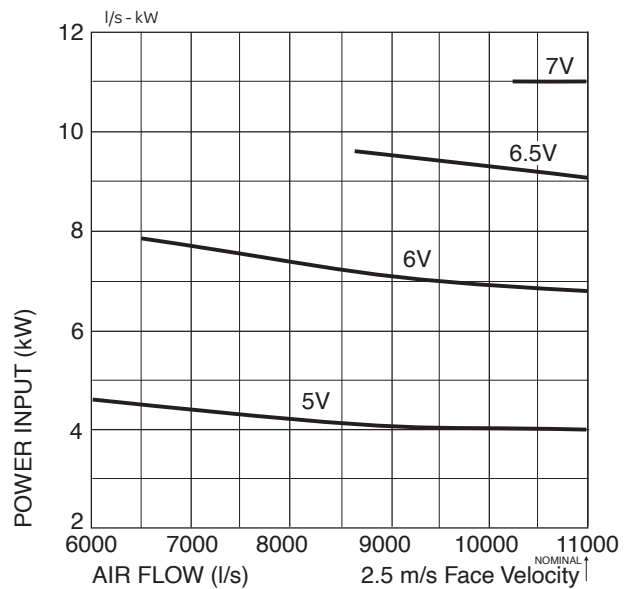
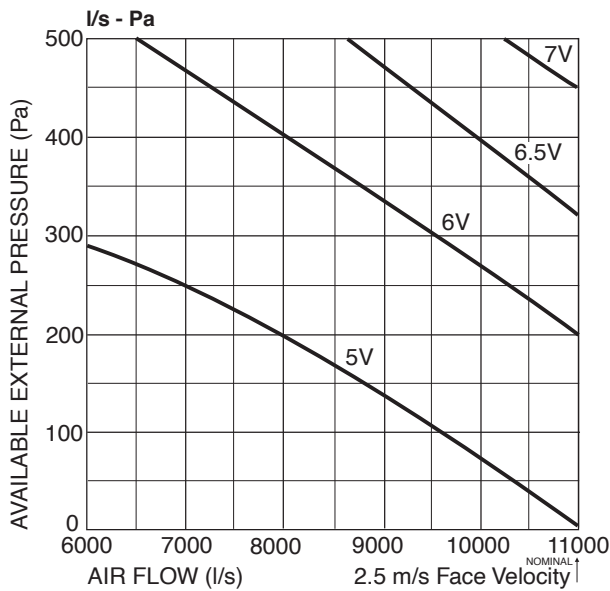

#### NB Air Flow Selection

If air returning to the indoor coil is regularly expected to be above 50% relative humidity then the coil face velocity should be limited to 2.5m/s or less (refer air flow graph above)

Consideration must be given to selecting a airflow and coil face velocity that avoids water carry-over problems, ie in high humidity (tropical/subtropical) conditions or when heavily moisture laden fresh air is introduced

A unit running below or above allowable air flow range can damage components and cause unnecessary unit protection 'tripping'..

## COMMISSIONING CHECK LIST

Site Name/address: .....

Installing Company ..... Date: .....

Serviceman: ..... Tel: .....

Model ..... Serial No..... Site Ref. ....

Unit mounted level?	Y / N	Supply voltage checked?	Y / N
Temperzone recommended drain trap fitted?	Y / N	External electrical isolator fitted?	Y / N
Water drains tested okay? (panels on, fan running)	Y / N	Indoor Plug fan set voltage or l/s	V      l/s
Does unit have adequate safe access?	Y / N	Are temperature controller's parameters set?	Y / N
All electrical terminals are tight?	Y / N	Checked for excessive noise & vibration of unit?	Y / N
Return air filters fitted?	Y / N	Has client had controls demo?	Y / N
Removed compressor shipping wedges?	Y / N	Electrical Certificate Of Compliance issued?	Y / N
Refrigeration leak checked?	Y / N	If installed indoors, is there adequate ventilation to disperse any refrigerant in the unlikely event of a leak.	Y / N
Is air flow set and balanced?	Y / N		
Thermostat type:	BMS / SAT-3 / TZT-100 / Other? (name):		

**Mark UC8 dip switch positions with an 'X'**

	SW1							
	1	2	3	4	5	6	7	8
On								
Off								

	SW2							
	9 (1)	10 (2)	11 (3)	12 (4)	13 (5)	14 (6)	15 (7)	16 (8)
On								
Off								

**Record the following UC8 monitored conditions using push button SW3 (repeat to scroll through list).**

**IMPORTANT:** Digital compressors must be operating at 100% for at least 10 minutes when taking these readings.

		System 1	System 2	System 3	System 4			
<b>COOLING CYCLE</b>	Low Pressure:	SLP	kPa	kPa	kPa	kPa	Outdoor Ambient temperature:	°C
	Evap temperature:	Et	°C	°C	°C	°C	Indoor Return air temperature:	°C
	Suction Line temperature:	SLt	°C	°C	°C	°C	Indoor Supply air temperature:	°C
	Suction Superheat:	SSH	K	K	K	K	Indoor fan amps :	A
	Discharge Line Pressure:	dLP	kPa	kPa	kPa	kPa	Fresh Air introduced :	%
	Condensing temperature:	Ct	°C	°C	°C	°C	Compressor 1 amps :	A
	Discharge Line temperature:	dLt	°C	°C	°C	°C	Compressor 2 amps :	A
	Discharge Superheat:	dSH	K	K	K	K	Compressor 3 amps :	A
	De-ice Sensor temperature:	ICEt	°C	°C	°C	°C	Compressor 4 amps :	A
	Required Capacity:	CAP	%	%	%	%		
	Expansion Valve 1:	EE1	%	%	%	%		
	Expansion Valve 2:	EE2	%	%	%	%		

<b>HEATING CYCLE</b>	Low Pressure:	SLP	kPa	kPa	kPa	kPa	Outdoor Ambient temperature:	°C
	Evaporating temperature:	Et	°C	°C	°C	°C	Indoor Return air temperature:	°C
	Suction Line temperature:	SLt	°C	°C	°C	°C	Indoor Supply air temperature:	°C
	Suction Superheat:	SSH	K	K	K	K	Indoor fan amps :	A
	Discharge Line Pressure:	dLP	kPa	kPa	kPa	kPa	Fresh Air introduced :	%
	Condensing temperature:	Ct	°C	°C	°C	°C	Compressor 1 amps :	A
	Discharge Line temperature:	dLt	°C	°C	°C	°C	Compressor 2 amps :	A
	Discharge Superheat:	dSH	K	K	K	K	Compressor 3 amps :	A
	De-ice Sensor temperature:	ICEt	°C	°C	°C	°C	Compressor 4 amps :	A
	Required Capacity:	CAP	%	%	%	%		
	Expansion Valve 1:	EE1	%	%	%	%		
	Expansion Valve 2:	EE2	%	%	%	%		

NOTE: This document to be kept with the unit. Failure to provide this completed page on request by Temperzone may affect unit warranty.

[www.temperzone.com](http://www.temperzone.com)

## Auckland

### Head Office

38 Tidal Rd, Mangere, Auckland  
Private Bag 93303, Otahuhu  
New Zealand

**Phone:** (09) 279 5250

**Email:** [sales@temperzone.co.nz](mailto:sales@temperzone.co.nz)

## Sydney

### Head Office

14 Carnegie Place, Blacktown  
NSW 2148  
PO Box 8064, Seven Hills West  
NSW 2147, Australia

**Phone:** (02) 8822 5700

**Email:** [sales@temperzone.com.au](mailto:sales@temperzone.com.au)

## Newcastle

**Phone:** (02) 4692 1155

**Email:** [sales@mcintoshair.com.au](mailto:sales@mcintoshair.com.au)

## Launceston

**Phone:** (03) 6331 4209

**Email:** [info@hvac-supplies.net](mailto:info@hvac-supplies.net)

## Hamilton

**Phone:** (07) 839 2705

**Email:** [tzhilton@temperzone.com](mailto:tzhilton@temperzone.com)

## Adelaide

**Phone:** (08) 8115 - 2111

**Email:** [sasales@temperzone.com.au](mailto:sasales@temperzone.com.au)

## Singapore

**Phone:** +65 6733 4292

**Email:** [sales@temperzone.com.sg](mailto:sales@temperzone.com.sg)

## Wellington

**Phone:** (04) 569 3262

**Email:** [wgtn@temperzone.com](mailto:wgtn@temperzone.com)

## Melbourne

**Phone:** (03) 8769 7600

**Email:** [vicsales@temperzone.com.au](mailto:vicsales@temperzone.com.au)

## Christchurch

**Phone:** (03) 379 3216

**Email:** [chch@temperzone.com](mailto:chch@temperzone.com)

## Brisbane

**Phone:** (07) 3308 8333

**Email:** [qldsales@temperzone.com.au](mailto:qldsales@temperzone.com.au)

## Perth

**Phone:** (08) 6399 5900

**Email:** [reception@airskill.com.au](mailto:reception@airskill.com.au)



Materials and specifications are subject to change without notice due to the manufacturer's ongoing research and development programme.