



OPA 1410/1710/2110 RLTM4FPQD(-Z) (Econex Pro) Air Cooled Packaged Units - Reverse Cycle - R32 Installation & Maintenance

CONTENTS	Page
1. GENERAL	1
2. INSTALLATION	2
3. REFRIGERATION SYSTEM.....	2
4. WIRING	3
5. ECONOMISER.....	3
6. START-UP PROCEDURE.....	3
7. OPERATION	7
8. MAINTENANCE	9
9. TROUBLESHOOTING	9
10. WARRANTY	9
APPENDIX I : CONTROLS SET-UP IP ADDRESS	10
APPENDIX II : MASTER CONTROLLER - SYSTEM INFO	11
APPENDIX III : UC8 PROTECTION FUNCTIONS.....	12
APPENDIX IV: AIR HANDLING PERFORMANCE	14
COMMISSIONING CHECK LIST	15

1. GENERAL

Temperzone OPA Outdoor Air Cooled Packaged units.

Follow these instructions to ensure the optimum performance, reliability and durability.

Units must be installed in accordance with all national and regional regulations and bylaws. National Health and Safety regulations must be followed to avoid personal injuries.

The appropriate local permits must be acquired and adhered to.

Local regulations on maximum boundary noise need to be considered when positioning the unit.

The accompanying 'R32 Handling Ducted Packaged Units' pamphlet forms part of these Installation & Maintenance instructions.

⚠ WARNING

These units use R32 refrigerant (Class A2L) which is mildly flammable.

The system shall be installed, operated and stored in a well ventilated space. If the refrigerant gas comes into contact with fire, a poisonous gas may occur. Be aware that R32 does not contain an odour.

If indoors, the appliance shall be stored in a room away from continuously operating sources known to cause ignition of R32 refrigerant (for example an operating gas appliance or operating electric heater)

2. INSTALLATION

2.1 Clearances & Service Access

Refer to Specification Sheet supplied for minimum clearances. If multiple units are to be placed side-by-side then allow at least 2 m between coil faces.

Filter slides are fitted within the unit. Access to the filter access door should be considered when designing return and supply air ductwork.

2.2 Pallet Removal

Prior to mounting the unit, remove all wooden pallets from beneath the mounting rails, by first temporarily removing the drain troughs (either side of unit) to gain access to the pallet screws. Replace the troughs when finished.

2.3 Mounting

The unit should be fastened to a firm flat horizontal base using the holes supplied in the mounting channels. When the unit is being installed on a roof it is recommended that the unit is installed on a substantial structure with vibration isolating pads or mounts. If placed on the ground or concrete pad, use rubber pads or mounts to give 20mm min. ground clearance.

Flexible duct connections are recommended between the supply and return ducts and the unit.

The unit is shipped with plastic wedges installed under the compressors. Ensure these wedges are removed from the compressor feet prior to starting the unit (not required for operation).

2.4 Condensate Drains

The condensate drains should be 'U' trapped outside the unit. The traps should have a vertical height of at least 100 mm. The drain lines should have a slope of at least 1 in 50 and must not be piped to a level above the unit drain pipe. 3. Refrigeration System

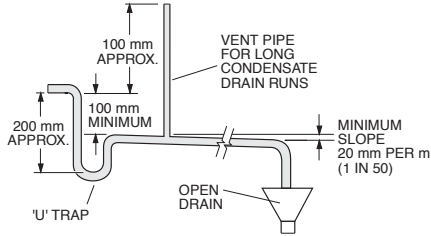

3. REFRIGERATION SYSTEM

3.1 General

Each OPA 1410/1710/2110 has four independent refrigeration systems, each with their own variable speed inverter compressor for close temperature control and better system efficiency.

Each refrigeration system has been charged with R32 refrigerant; refer Specifications document for amount.

3.2 Compressors

The compressors are inverter scroll type. The compressor lubricant is POE-46 (NXG5020 or equivalent). Note, this oil absorbs moisture quickly if exposed to open air.

Some models are a mix of single inverter and three fixed speed compressors. Please check the Specification Sheet relevant to your unit.

4. WIRING

4.1 Electrical Requirements

Electrical work must be done by a qualified electrician and meet standard AS/NZS 3000.

DANGER! LIVE ELECTRICAL CONNECTIONS. ISOLATE MAINS POWER BEFORE WORKING ON UNIT. ONLY QUALIFIED PERSONS WHO ARE COMPETENTLY TRAINED SHOULD PERFORM SERVICE AND MAINTENANCE TASKS.

The unit must be wired directly from a distribution board using an appropriately sized circuit breaker. The termination point for the mains cable is in the electrical compartment. An isolating switch is required, near but not on the unit.

A hole for power cable entry is provided bottom right-hand corner, next to the compressor access door. From there route the cable into the electrical box via the hole on the bottom of the electrical box or through the hole on the RH side of the electrical box.

4.2 Controls Wiring

A hole for communication cable entry is provided bottom left-hand corner, next to the compressor access door. Before wiring, the method of control should be established from the following list. Follow specific instructions in the following sections. Section 4.3 is important to all sections.

Control method	Section
Sensors and Inputs	4.3
BMS – BACnet Interface	4.4
BMS – Modbus Interface	4.5
Standalone	4.5

4.3 Sensors & Inputs

See table below for sensors and inputs required for each control method.

Carel c.pCO connections	Pin	Signal	Factory Fitted	BMS Bacnet/Modbus	BMS-Low Level Controller	Stand alone
Room Temp.	U1	0-10VDC	Note 1	Note 3	x	√
Room RH%	U2	0-10VDC	Note 1	Note 3	x	√
ID Fan Speed Req	U3	0-10VDC	x	Note 2		
RA Temp.	U4	NTC	√	√	√	√
RA RH%	U5	0-5VDC	√	Note 4		
SA Temp.	S4	NTC	√	√	√	√
SA RH%	S3	0-5VDC	√	√	√	√
CO2	U8	0-10VDC	Note 1	Note 1	0	√

The following inputs relate only when using external low level control:

Enable	ID4	24VAC	x	x	√	x
--------	-----	-------	---	---	---	---

Occupancy	ID6	24VAC	x	x	√	x
Fault	NO7	Relay	x	x	√	x

Notes:

1. Factory supplied loose, fit as required in controlled space.
2. Optionally provide 0-10VDC control of indoor fan speed, will be overridden if written to BACnet or Modbus indoor fan speed register. Can also be set using a Carel pGD.
3. Room temperature and RH% can be written via BACnet or Modbus and will take priority over sensor reading, in this case sensors are not required to be fitted.
4. RA sensors are required for Economiser option. If RA to be used to control the space then wire RA sensors into the Room temperature and Room RH% inputs.

4.4 BMS – BACnet Interface

1. Install ethernet cat 5 (or cat 6) STP cable between the port shown in the below diagram of the Carel c.pCO controller and the network switch of the BMS. The default IP address of the controller is 192.168.1.10; refer Controls Setup (p.9) for details on how to change.
2. Temperature and humidity sensors can be connected directly to the Carel c.pCO controller (see specification sheet for wiring diagram). Alternately the space temperature and humidity can be written by the BMS to BACnet objects which will take priority over any sensors that are connected.

Single unit to BMS:

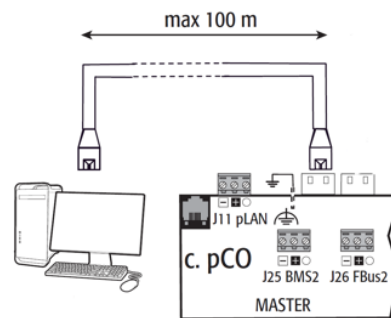

Multiple units using a network switch:

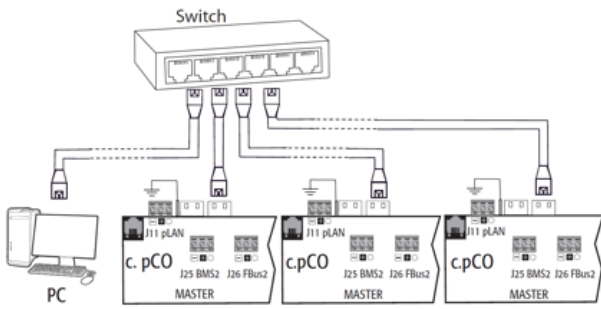

4.5 BMS – Modbus Connection

Connect to supplied terminals in electrical box; refer Specifications document for wiring detail, sheet 2 grid reference D0, reproduced below.

Figure 1: RS485 terminal block in electrical box

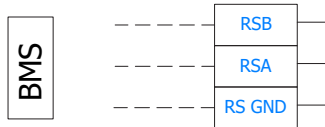
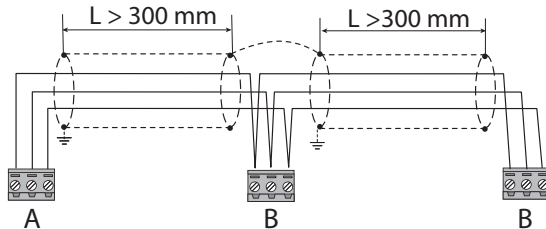

Figure 2: Carel recommendations for shield grounding



4.6 Stand Alone

Option 1:

1. Install optional *Carel pGD1* remote display (Item no. 201-000-379) inside building, connection to *Carel c.pCO* master controller J10 port. Cable RJ12. Maximum distance 50m; up to 200m using AWG24 shielded cable and card adaptor.
2. Connect Room temperature and humidity sensor directly to *Carel c.pCO* master controller. See Specification sheet for wiring schematic/sheet 4 for wiring details of Room temperature input and Room RH%.

Option 2:

In absence of a *Carel* remote *pGD1* the unit can be controlled using the on-board *Carel c.pCO* master controller with its included digital display.

4.7 Remote on/off

Connect a 24V control signal to the unit's 'Enable Input' terminal (refer Wiring Schematic, Sheet 3). A 24V signal will enable the unit to operate; no voltage will disable the unit.

4.8 Economiser Wiring

See Specifications document for wiring schematic/ sheet 1, lower left corner.

UC8 Master-Slave Connection

5. ECONOMISER OPTION

The Economiser package that is factory fitted consists of two opposed blade dampers, one for the fresh air and the other for the return air. They come complete with individual damper motors controlled using a 0–10V dc signal. The package also includes a weatherhood assembly that is usually supplied as a separate item for fitting on site. It is important that the installation instructions for the fitting of the weatherhood are followed otherwise it is possible some water ingress from rain could occur.

If the outdoor temperature as well as the enthalpy is below that of the return air, the fresh air damper can be opened and the return air damper closed to provide the first stage of cooling.

The air damper's minimum and maximum openings can be adjusted using the Master Controller (*c.pCO*) Menu/ Settings/Damper Config. Each of the dampers can have settings for use in both the occupied and unoccupied modes. The settings for opening based on an optional CO₂ air quality sensor can also be adjusted. Many installations may require a minimum fresh air introduction of 10–15% (refer AS/NZS 1668) and the stop may be set on site to facilitate this. Ensure the air flow entering the unit is equal between full return air and full Economiser by adjusting the damper stops on both Return and Fresh air dampers.

6. START-UP PROCEDURE

6.1 Before starting the compressors

1. Before working on the unit isolate mains power.
2. Remove the shipping wedges from beneath each compressor. Check that each compressor is securely mounted.
3. Check oil level as per label attached to each compressor.
4. Check the mains power and controls wiring are correct.
5. Check tightness of all electrical connections.
6. Check the air filters have been correctly installed.
7. Check that all indoor fan motors can freely rotate.
8. Check the supply voltage between each phase and neutral.
9. Check air diffusers and ductwork are open.
10. Apply mains power to the unit by closing the mains isolating switch.
11. Before starting the compressors a four hour delay period is required to allow the crankcase heaters to drive any liquid refrigerant out of the compressor oil. Mains power must be switched on during this four hour delay period.

6.2 Master Controller Display (*Carel c.pCO*)

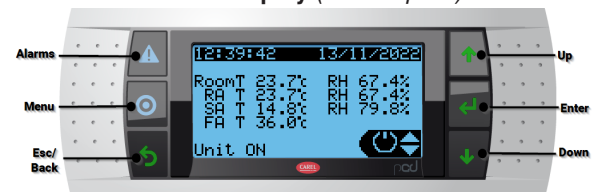

Button	Function
Alarm	System Alarm indication and Reset
Menu	Go to Main menu
Esc	Return to previous page or Exit menu

Main Menu:

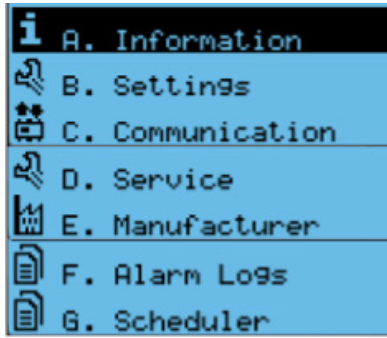

6.3 Commissioning

After the four hour delay period has expired (see step 11 in section 6.1) complete the following procedure. You can use the Commissioning Sheet (supplied with the unit) to help you.

1. From the initial screen of the Master Controller press Menu button  to bring up the Main menu.
2. Scroll down and select 'D. Service'. Enter password '2100'.
3. Scroll down and select 'Manual Control'.
4. Scroll to 'Manual Airflow'. First enter airflow requirement in litres/second then select 'Yes' under enable to start indoor fan operation. (refer Note below)
5. Measure air flows from duct work to verify air flows, record current draw on each fan and then disable 'Manual Airflow'.
6. Scroll to sub menu 'B. Settings' and select 'Fan Config'. Change fan mode to either 'Airflow', 'Fixed Speed' or '0-10VDC'.
7. Change airflow setpoint on following pages to match verified airflows. If using fixed speed, set speed in % and cross check current draw against airflow measurements. Otherwise set airflow in litres/second as per measured values.
8. Scroll back to 'D. Service' menu and manual 'control menu'.
9. Navigate to 'Manual Unit Capacity' and select capacity requirement. 100% = all compressor stages on. NOTE:
 - i. This does not correspond to compressor speed.
 - ii. Unit will need to be turned on by keypad to allow the capacity control to function.
10. Allow compressors to run for a short duration while checking for any unusual noises or vibrations.
11. Measure the current draw on each phase to the compressor motor and to each fan motor. Check the readings against the specified values in the wiring diagram or Specification sheet.
12. Check each refrigeration system's information, from the Main menu select 'Information', then 'UC8' (refer Appendix I for more detail). Also check Information/Power usage.
13. Once testing is complete disable 'Manual Unit Capacity'.
14. Remove any swarf found inside the unit and touch up any external paintwork damage incurred in transit to prevent corrosion.

Note:

Setting the indoor fan speed too low can bring risk of frost forming on the indoor coil with potential nuisance frost protection trips on cooling, possibly even unit lock-out, and/or HP trips on heating.

Setting the indoor fan speed too high can bring a risk of blowing moisture off the fins of the indoor coil and into the supply air duct. Water could then start leaking from the ceiling diffusers and corrosion of ducting may occur.

Setting the indoor fan speed too high can also bring a risk of 'over-condensing' (when the unit is heating) which in turn could cause the unit to form more outdoor coil de-ice cycles than necessary.

Outdoor fans do not necessarily start rotating immediately after the compressor is started. The fans may run-on for a short period after the compressor stops.

The indoor fan will reduce speed if in heating mode and the condensing temperature is too low to automatically allow the condenser coil to warm up. The fan speed may also slightly reduce when in Latent Cooling mode, if this option is enabled.

7. OPERATION

7.1 BMS – BACnet

Configure the IP address as required, see Appendix for details.

Once connected to the BMS server, to start the unit via BACnet if the room temperature and RH% sensors are connected directly to the controller and the indoor fan speed has been set using the PGD then all that needs to be done is to write to the below BACnet objects.

Type	Object Instance	Object Name	Read/Write	Units	Default	Range	Description
BinaryValue	1	BMS.Unit_OnOff	RW	Bool	0	0 to 1	Enable Unit to run
AnalogValue	30	BN.SP_Cooling	RW	°C	22	15.1~35.0	Cooling SP, must be > heat SP
AnalogValue	31	BN.SP_Heating	RW	°C	20	15.0~34.4	Heat SP, must be < cool SP

If the Room temperature and RH% are measured by the BMS then the below objects also need to be written.

Type	Object Instance	Object Name	Read/Write	Units	Default	Range	Description
BinaryValue	4	BMS.RoomT_RH_ORide	RW	Bool	0	Bool	Use BACnet Room temp and RH (BMS_RoomT and BMS_Room_RH) for control
AnalogValue	36	BN.OV_RoomAirT	RW	°C	-	5-35	Room temperature written by BMS
AnalogValue	37	BN.OV_RoomRH	RW	RH%	-	0-100	Room RH% written by BMS.

To adjust the air flow via BACnet the following object needs to be written.

Type	Object Instance	Object Name	Read/Write	Units	Default	Range	Description
AnalogValue	44	BN.SP_Air_Flow_Setpoint	RW	l/s	10000	0-13750	Air flow l/s setpoint



BACnet license pre-installed in temperzone factory.

7.2 BMS Modbus

For information regarding using Modbus commands, please ask temperzone.

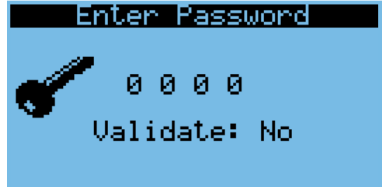
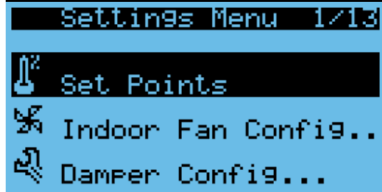

7.3 Stand Alone Unit

Master controller site set-up:

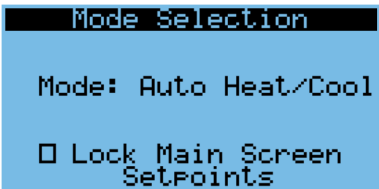
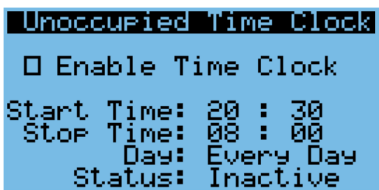
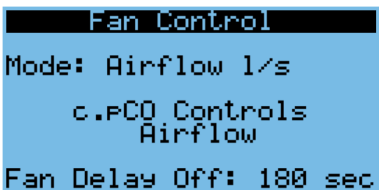
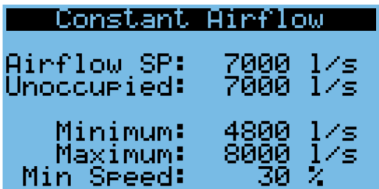
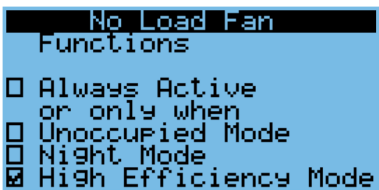
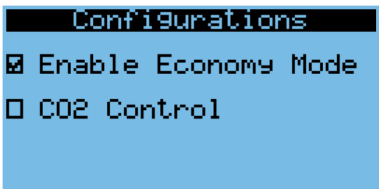
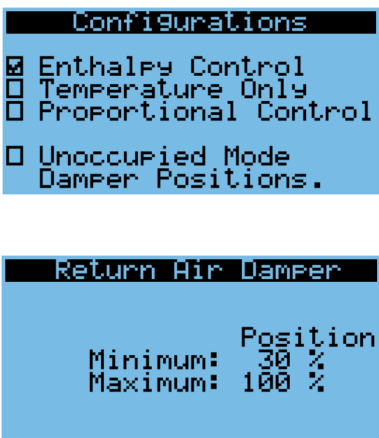

<p>1. Press Program button  to bring up the Main Menu</p>	
<p>2. Press (↓), then select 'B. Settings' (↵). Enter password to login. Default password is '2100'; this can be changed by user. Validate the password (↵) to confirm.</p>	
<p>3. Select 'Set Points' (↵)</p>	

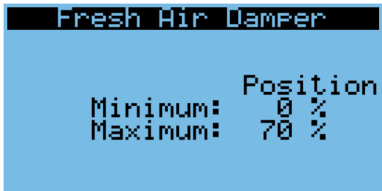
<p>4. Skip past this page (↓) unless you want to change the factory setting. The mode of the unit can be limited to heating only or cooling only, if required to suit the application.</p>	<pre> Mode Selection Mode: Auto Heat/Cool <input type="checkbox"/> Lock Main Screen Setpoints </pre>
<p>Setpoints</p> <p>5. Use Up/Down (↑/↓) keys to adjust the value or press enter key (↵) to move to the next value. The page shown is for the occupied settings. Once done press enter until it flashes in the top left corner. Now press the down key (↓) to move to the next page, or esc key (⇧) to go back to the Settings Menu.</p>	<pre> Room Setpoint Cooling: 23.0 °C Heating: 21.0 °C RH: 55.0 % </pre>
<p>6. The second page allows the Unoccupied settings to be changed.</p>	<pre> Unoccupied Setpoint Cooling: 24.0 °C Heating: 18.0 °C RH: 55.0 % </pre>
<p>7. Scroll down (↓) to the next page. The deadbands can be adjusted, these control the how far past the setpoint before the mode is turned on or off.</p>	<pre> Deadband Setpoints Cooling Mode Start: 0.3 K (23.3°C) Stop: 0.5 K (22.5°C) </pre>
<p>8. Scroll down (↓) to the next page. To prevent moisture formation on duct work when the unit is running in cooling mode, if the optional reheat coil is installed this function will control the supply air to be above the dewpoint temperature of the room.</p>	<pre> Deadband Setpoints Heating Mode Start: 0.3 K (20.7°C) Stop: 0.5 K (21.5°C) Dehum Reheat Dewpoint Dewpoint SP: 13.5 °C Dewpoint Deadband Below: 1.5 K </pre>
<p>9. Scroll down (↓) to the next page. If the optional reheat coils are fitted then a supply air temperature can be set when operating in dehum mode when the room temperature is within setpoint and the RH is too high.</p>	<pre> Dehum Reheat Reheat Supply Air T Offset: -3.0 K (SA_T = Cooling SP + Offset) Target SA_T: 20.0 °C </pre>
<p>10. Scroll down (↓) to the next page. Quick access to a daily schedule to set the hours of Night Mode. Night mode reduces the outdoor fan use to provide lower noise levels during operation.</p>	<pre> Night Mode Clock <input type="checkbox"/> Enable Time Clock Start Time: 20 : 30 Stop Time: 09 : 00 <input type="checkbox"/> Force Night Mode Status: Inactive </pre>

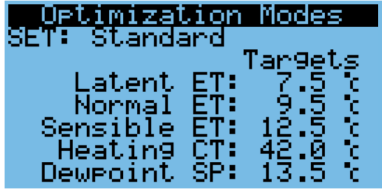
<p>11. Scroll down (↓) to the next page.</p>	
<p>12. Scroll down (↓) to the next page. Quick access to a daily schedule to set the Unoccupied hours.</p> <p>Return to the Main Menu (↵)</p>	
<p>Indoor Fan Configuration</p> <p>13. Main Menu/Settings/Indoor Fan Config./Fan Control Method (1). For setting of the fan control method. Options: constant air flow or speed controlled, 0-10V dc input</p>	
<p>14. Main Menu/Settings/Fan Config./Constant Air Flow (2). Scroll down to the next page. A pressure sensor is factory fitted to the indoor fans allowing the air flow to be automatically controlled. Set the flow in l/s.</p>	
<p>15. Menu/Settings/Fan Config./No Load Fan (3). For setting of the fan status when there is no load on the system.</p> <p>Return to the Main Menu (↵)</p>	
<p>Damper Configuration</p> <p>16. Main Menu/Settings/Damper Config. Select 'Damper Config.' (↵) For units supplied with Economiser Package, Economy Mode is enabled. Scroll down (↓) to the next page</p>	
<p>17. For units supplied with Economiser Package, Enthalpy Control is the recommended control method. Options are available to control the economiser dampers: unoccupied mode, damper stroke, damper direction, fresh air inlet Scroll down (↓) to see the next pages.</p>	

	
<p>Spill Air Damper setting is only applicable to units supplied with this option.</p> <p>Return to the Main Menu (↵)</p>	
<p>16. Main Menu/Settings/Optimization</p> <p>Quick settings for how the unit operates and controls the coil temperatures during each of the comfort modes. Chose between Standard, High Efficiency and High Performance modes. A manual mode is also provided that allows for each setting to be tailored.</p>	

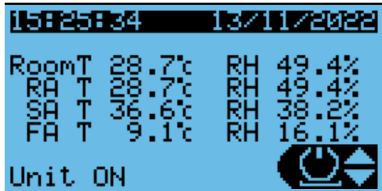
To Power ON the unit from the controller, follow the below instructions:

<p>1. From the Home screen (shown here), use the Up/Down keys (↑/↓) to select the ON/OFF symbol, as shown in the lower righthand corner. Press enter (↵).</p>	
<p>2. At the next screen use the Up/Down keys (↑/↓) to turn the unit ON then press enter (↵) to confirm.</p>	

To identify the Controller software version (and other status information):

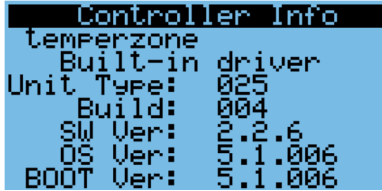
<p>From the Home screen, use the Up/Down keys (↑/↓) to select the ON/OFF symbol as shown in the screen in the lower righthand corner (see Step 1 above).</p> <p>Use the Up/Down keys (↑/↓) to select 'i'. Press enter (↵)</p> <p>Other information available by scrolling down (↓), includes Target Setpoints and operating Status conditions.</p> <p>Press esc key (⇧) to go back to the Home screen.</p>	
--	--

Note: Screen content can change depending on software version, due to our policy of continuous improvement.

8. MAINTENANCE

⚠ WARNING! HAZARDOUS VOLTAGE. ENSURE ALL POWER SUPPLIES ARE ISOLATED BEFORE PERFORMING MAINTENANCE. FAILURE TO ISOLATE POWER CAN LEAD TO SERIOUS INJURY.

8.1 Monthly

1. Check air filters and vacuum, wash clean or replace as necessary.
2. Check condensate drain for free drainage.
3. Check compressor compartment for oil stains indicating refrigerant leaks.

⚠ WARNING

Under no circumstances shall potential sources of ignition be used in the searching for or detection of refrigerant leaks. If a leak is suspected, all naked flames shall be removed/extinguished.

If a leakage of refrigerant is found which requires brazing, all of the refrigerant shall be recovered from the system.

4. Check system operating pressures via the *Carel c.pCO* controller (refer Appendix I).

8.2 Every Three Months

1. Check operation of Economiser dampers.
2. Check for obstruction of Economiser dampers.

8.3 Six Monthly

1. Check the tightness of electrical connections.
2. Check for signs of corrosion on electrical connections in high salt atmospheres; replace where necessary.
3. Check the tightness of all fan motor mountings
4. Check system operating pressures via the *Carel c.pCO* controller (refer Appendix I).
5. Check condensate drain for free drainage.

8.4 Yearly

1. Check all refrigerant piping for chafing and vibration.
2. Check air supply at all diffusers
3. Check for excessive noise and vibration and correct as necessary.
4. Check for insulation and duct damage and repair as necessary.
5. Check sensor values with calibration tool.
Adjust +/- offset via Settings/Sensor routing MENU.
6. Check system operating pressures via the *Carel c.pCO* controller (refer Appendix I).
7. Remove lint and dust accumulation from outdoor coil fins with soft brush or low pressure water spray. In corrosive environments, the checking and cleaning frequency should be increased.
8. Touch up any paintwork damage to prevent corrosion.

9. TROUBLESHOOTING

9.1 Room temperature varies significantly from its setting

- Unit may have been incorrectly sized for the building.
- Drafts from wrongly placed supply air diffusers or from the back of the wall plaque could be affecting the temperature sensor built into the wall plaque.
- Poor air circulation in the room can cause incorrect temperature readings.

9.2 Air conditioner does not seem to deliver the heating when most needed

- Heating capacity at design conditions may be incorrect. As the outside temperature falls, heat losses through the walls, floor and ceiling increase.

- Check the unit's brochure for information on the minimum/maximum operating temperatures.
- When heating, units have de-icing cycles built-in to remove ice on the outdoor coils. This usually means reversing the cycle on some, but not all systems at once, for a few minutes. Heating may be slightly reduced at this time, but usually not noticeable.

9.3 In a new building, why does it take some days before the air conditioning heat pump unit seems to work properly

- Many new buildings, especially a commercial buildings, have a large amount of concrete and other structural materials that are generally cold and full of moisture. This is most evident in the winter when trying to heat the building from a cold start or outdoor ambient condition.

9.4 Unit is leaking water

- Check the drain trap/vent/slope.
- Water carry-over: Reduce the maximum fan speed. Refer Appendix IV for indoor airflow range.
- Check fresh air damper is not opened by BMS when raining outside

9.5 Air conditioner runs excessively – the temperature remains too hot in summer or too cold in winter

- Windows or doors may be opened to non conditioned areas.
- Keep doors to unconditioned areas closed.
- Leaves, papers or other items blocking air flow over the outdoor unit coil.
- Location of wall controller or remote temperature sensor is incorrect.
- Check for leaks in supply or return air ductwork.

9.6 Unit displays an error code:

- Refer to UC8 Controller label on the unit for operation & fault diagnostics information or visit www.temperzone.biz; model search 'UC8 Controller'.
- Press the Alarm button on the *c.pCO* or *pGD* to list the most recent faults. Refer OPA 1470/1710/2100 Controller Manual for an explanation.

10. WARRANTY

Please refer to the separate warranty document supplied with the unit, or visit www.temperzone.com for details.

Australia:

warranty@temperzone.com.au

spares@temperzone.com.au

Telephone: 1800 21 1800

New Zealand:



customerservices@temperzone.co.nz

Telephone: 0800 TZWARRANTY (899 2777)

APPENDIX I



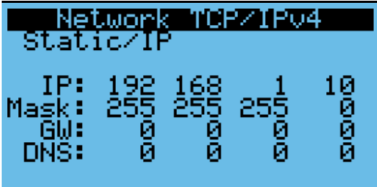

CONTROLS SET-UP : IP ADDRESS

The default IP address of the controller is '192.168.1.10'. To change follow the below instructions.

<p>1. Press Alarm and Enter together for 3 seconds to access the system menu. Scroll to 'Settings' and press Enter button</p>	 <pre>Settings Menu 6/13 Optimization Modes Serial Ports BACnet</pre>
<p>2. Scroll to 'TCP/IP settings' and press Enter button</p>	 <pre>BACnet TCP/IP BACnet Instance Current: 77001 New: 77001 Update: No</pre>
<p>3. Select Settings: Default: Static (refer Temperzone for a change to DHCP) IP: Enter an address in the same subnet set on the PC, for example: IP: 192.168.1.1 MASK: 255.255.255.0 GW: Enter as required, must start with first 3 parts identical to IP as set by mask. DNS: Enter as required</p> <p>Select Update configuration --> Yes</p>	 <pre>Network TCP/IPv4 Static/IPv4 IP: 192 168 1 10 Mask: 255 255 255 0 GW: 0 0 0 0 DNS: 0 0 0 0</pre>

APPENDIX II

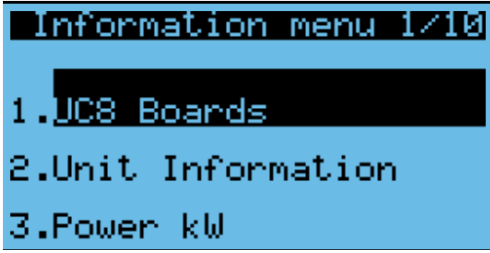
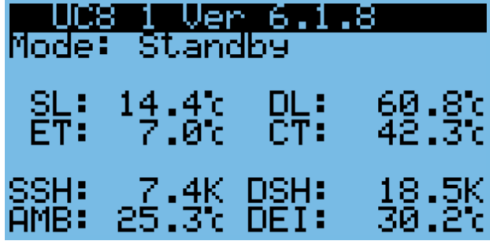
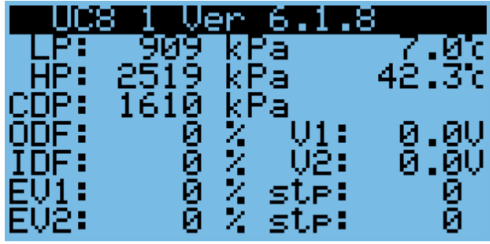
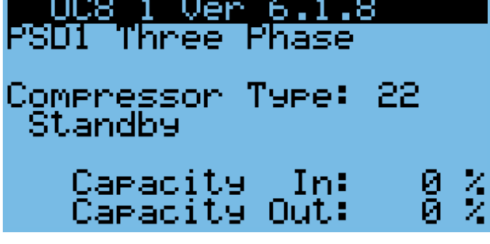
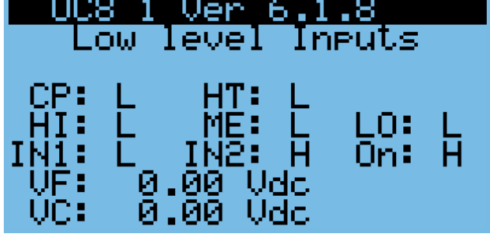
MASTER CONTROLLER : SYSTEM INFORMATION

<p>1. Press Program button  to bring up the Main Menu Select 'A. Information'.</p>																															
<p>2. Select 'UC8 Boards'. There are up to four separate UC8 controllers in an OPA 1410/1710/2110 – one per refrigeration system.</p>																															
<p>3. UC8 Info.screens. These show the UC8 controller variables such as suction superheat, expansion valve position, etc. Refer table below for key to abbreviations:</p> <table border="1" data-bbox="140 943 563 1529"> <thead> <tr> <th>Abbrev..</th> <th>Description</th> </tr> </thead> <tbody> <tr> <td>AMB</td> <td>Ambient Temp. °C</td> </tr> <tr> <td>DEI</td> <td>De-ice sensor temp. °C</td> </tr> <tr> <td>SL</td> <td>Suction line temp. °C</td> </tr> <tr> <td>ET</td> <td>Evaporation temp. °C</td> </tr> <tr> <td>DL</td> <td>Discharge line temp. °C</td> </tr> <tr> <td>CT</td> <td>Condenser temp. °C</td> </tr> <tr> <td>SSH</td> <td>Suction superheat K</td> </tr> <tr> <td>DSH</td> <td>Discharge superheat K</td> </tr> <tr> <td>ODF</td> <td>Outdoor fan speed</td> </tr> <tr> <td>IDF</td> <td>Indoor fan speed</td> </tr> <tr> <td>HP</td> <td>Discharge pressure kPa</td> </tr> <tr> <td>LP</td> <td>Suction pressure kPa</td> </tr> <tr> <td>EV1</td> <td>Expansion valve A %</td> </tr> <tr> <td>EV2</td> <td>Expansion valve B %</td> </tr> </tbody> </table>	Abbrev..	Description	AMB	Ambient Temp. °C	DEI	De-ice sensor temp. °C	SL	Suction line temp. °C	ET	Evaporation temp. °C	DL	Discharge line temp. °C	CT	Condenser temp. °C	SSH	Suction superheat K	DSH	Discharge superheat K	ODF	Outdoor fan speed	IDF	Indoor fan speed	HP	Discharge pressure kPa	LP	Suction pressure kPa	EV1	Expansion valve A %	EV2	Expansion valve B %	   
Abbrev..	Description																														
AMB	Ambient Temp. °C																														
DEI	De-ice sensor temp. °C																														
SL	Suction line temp. °C																														
ET	Evaporation temp. °C																														
DL	Discharge line temp. °C																														
CT	Condenser temp. °C																														
SSH	Suction superheat K																														
DSH	Discharge superheat K																														
ODF	Outdoor fan speed																														
IDF	Indoor fan speed																														
HP	Discharge pressure kPa																														
LP	Suction pressure kPa																														
EV1	Expansion valve A %																														
EV2	Expansion valve B %																														
<p>4. Scroll down to see UC8 systems 2 to 4.</p>																															
<p>5. Press Program button  to return to the Main Menu</p>																															

APPENDIX III

UC8 PROTECTION FUNCTIONS

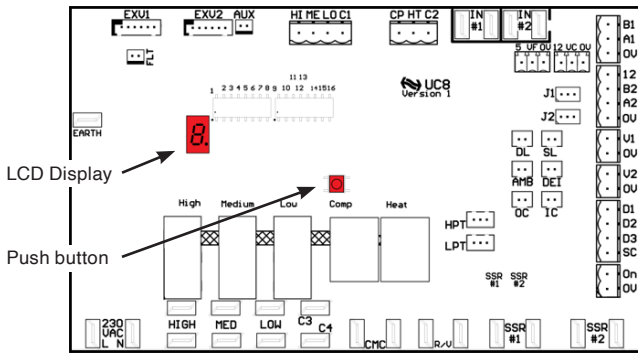

Each OPA Econex unit utilises up to four UC8 Controllers, one for each refrigeration system. The UC8 controllers receive requests from the Master Controller such as 'Unit On/Off', 'Start compressors', 'Activate HEAT (Reverse Cycle)' and transfer the requests to the outputs after enforcing safety timers.

Each UC8 implements system protection functions such as indoor coil frost, extreme high and low pressures, rapid on-off cycling of the compressors, loss of refrigerant and more.

The following applies to all protection functions except where otherwise indicated:

Unit operating capacity may automatically be reduced before a protection function is activated. Such a reduction may be sufficient to prevent an actual trip from occurring.

When a compressor is stopped by a protection function it is held off for a period of 3 minutes, after which it is allowed to restart (provided the cause of the trip has cleared).

When a protection function is active and when a unit is locked out the alarm relay output "FLT" is active.

Fault codes on the Econex Pro can be read on the UC8 display or on the *Carel c.pCO* fault log. For more information about protection functions and troubleshooting, refer to document "UC8 Troubleshooting", available at www.temperzone.biz website; model search 'UC8'.

1 High pressure protection (HP)

OPA Econex units are fitted with high pressure transducers connected to UC8 input HPT. A compressor is switched off when the discharge line pressure reading approx. 4200 kPa.

The display shows the letters 'HP' when protection is active.

2 Low pressure protection (LP)

OPA Econex units are fitted with low pressure transducers connected to UC8 input LPT. A compressor is switched off when the suction line pressure reading falls below approx. 230 kPa.

The display shows the letters 'LP' when protection is active.

3 Indoor coil frost protection

When the unit is cooling the evaporating temperature in the indoor coil should remain above -8°C. If this temperature falls below -8°C then ice (frost) likely will form on the indoor coil. If the low temperature persists for longer than 6 minutes then the protection function activates.

When indoor coil frost protection is activated the compressor is stopped for 6 minutes, after which it is allowed to restart.

4 High discharge line temperature protection

The controller monitors the compressor discharge line temperature via a sensor connected to input 'DL' (red wires). The compressor is stopped when:

- The temperature rises above 115°C for longer than 15 minutes.
- The temperature rises above 125°C (immediate action).

The display shows the message 'Hi-t' when protection is active.

5 High discharge superheat protection

Discharge superheat is defined as the difference between the compressor discharge gas temperature and the condensing temperature. When this temperature differential becomes very high it is an indication that the compressor is being starved of refrigerant gas. Common reasons for this could be a lack of refrigerant (under-charged or loss-of-charge), a blockage in the pipework or loose wiring to an EEV.

The protection is activated when R32 discharge superheat exceeds 60K for longer than 30 minutes.

The display shows the message 'Hi-dSH' when protection is active.

6 Low discharge superheat protection

Discharge superheat is defined as the difference between the compressor discharge gas temperature and the condensing temperature. When this temperature differential stays very low it can be an indication that the compressor is being flooded with liquid refrigerant. Common reasons for this could be an excess of refrigerant (over-charged) or a problem with the expansion device (for example a stuck accumulator or loose wiring to an EEV).

The protection is activated when discharge superheat remains below the threshold for longer than 15 minutes. The threshold varies linearly from 0K at standard mode minimum capacity (40%) to 10K at nominal capacity (100%).

This protection function is disabled when a compressor operates at less than standard mode minimum capacity (< 40%).

The threshold for a variable speed compressor operated in boost mode (capacity above 100%) is fixed at 10K.

The display shows the message 'LO-dSH' when protection is active.

7 High evaporation temperature / high suction line temperature protection

When the unit has a low pressure transducer connected to the compressor suction line then the controller calculates the evaporating temperature from the suction line pressure reading. If the unit does not have a low pressure transducer then the controller finds the evaporating temperature via a coil temperature sensor (input IC when the unit is cooling, input OC when the unit is heating, yellow wires). Additionally the controller monitors the compressor suction line temperature via a sensor connected to input 'SL' (white wires).

The protection function stops the compressor when:

- The evaporating temperature remains above 27.5°C for longer than 15 minutes.
- The suction line temperature remains above 30°C for longer than 15 minutes.

The display shows the message 'Hi-SL' when protection is active.

8 Other alarms

The Master Controller performs many other protection functions. For example:

- Signals from sensors and transducers must remain inside normal operating range.
- Modbus RTU communications with *Carel c.pCO* and *Carel Power+* inverter) must continue uninterrupted.
- Modbus RTU communications with a controller such as a BMS that is controlling the unit must continue uninterrupted.

Refer to document 'UC8 Troubleshooting Guide' for details.

9 Lock-out

Each protection function has a trip counter. A trip counter is reset to 0 whenever the compressor run request is removed. Any trip that has occurred more than 12 hours ago is removed from the trip count. For some protection functions, when the trip counter reaches value 3 (i.e. three consecutive trips occur) then the unit is "locked out".

When a unit is locked out the compressor is not allowed to start. Lock-out is designed to protect the compressor from repeatedly starting when a serious fault exists that requires the attention of a service technician.

The display shows the code of the fault that caused the lock-out condition.

A unit that is locked out can be unlocked using any one of the following methods:

- Remove mains power from the unit for at least 3 seconds, then restore power (NB repetitive lockouts cannot be reset by power interruption. Press SW3 pushbutton once reset the lockout fault).
- Issue an 'unlock' command via Modbus RTU serial communications.
- Reset the controller via Modbus RTU serial communications.

10 Safety timers

Each UC8 slave controller receives control signals and transfers the signals to the outputs after enforcing safety timers and other protection functions. If the compressor is held off, or held on, by a safety timer then the display shows message 'H-O-L-d'.



Normal durations of safety timers are:

- Minimum off time 3 minutes
- Minimum run time 1.5 minutes
- Min. cycle time 6 minutes (up to 10 compressor starts per hour)
- Min. mode change-over time 10 minutes (cooling to heating or vice-versa)

Note:

If a unit operates on low capacity for extended periods then the unit may periodically perform oil flush cycles. Under such operating conditions compressor lubricating oil may slowly settle in parts of the refrigeration system other than the compressor; oil flush cycles help to return the lubricating oil to the compressor. During an oil flush cycle compressor capacity is increased to a certain minimum. The duration of an oil flush cycle is 1 minute.

APPENDIX IV

AIR HANDLING PERFORMANCE

Note: Airflows are for a dry coil. Refer Airflow Selection below.

As filters thickness varies, the fan air flows given are for units installed without filters.

No allowance for Reheat coil option.

OPA 1410RLTMFPQ

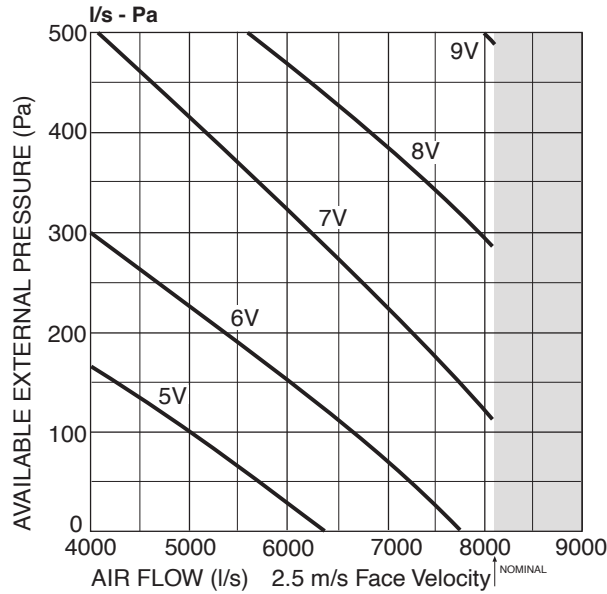

OPA 2110RLTMFPQ

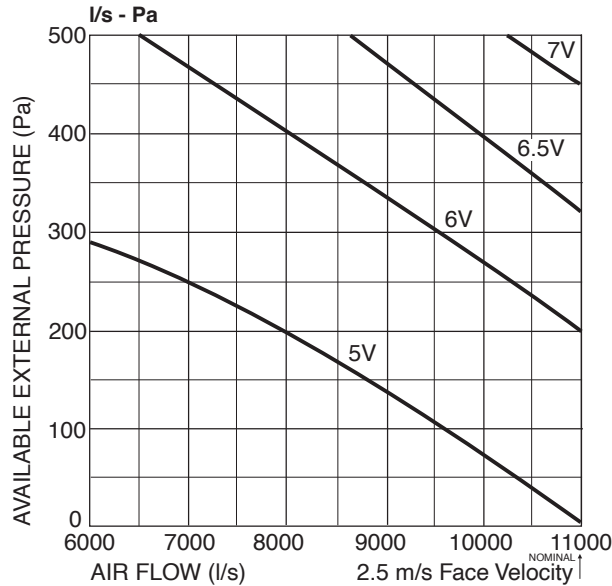

NB Air Flow Selection

If air returning to the indoor coil is regularly expected to be above 50% relative humidity then the coil face velocity should be limited to 2.5m/s or less (refer air flow graph above)

Consideration must be given to selecting a airflow and coil face velocity that avoids water carry-over problems, ie in high humidity (tropical/subtropical) conditions or when heavily moisture laden fresh air is introduced

COMMISSIONING CHECK LIST

Site Name/address:

Installing Company Date:

Serviceman: Tel:

Model Serial No. Site Ref.

Unit mounted level?	Y / N	Supply voltage checked?	Y / N
Temperzone recommended drain trap fitted?	Y / N	External electrical isolator fitted?	Y / N
Water drains tested okay? (panels on, fan running)	Y / N	Indoor Plug fan set voltage or l/s	V l/s
Does unit have adequate safe access?	Y / N	Are temperature controller's parameters set?	Y / N
All electrical terminals are tight?	Y / N	Checked for excessive noise & vibration of unit?	Y / N
Return air filters fitted?	Y / N	Has client had controls demo?	Y / N
Removed compressor shipping wedges?	Y / N	Electrical Certificate Of Compliance issued?	Y / N
Refrigeration leak checked?	Y / N	If installed indoors, is there adequate ventilation to disperse any refrigerant in the unlikely event of a leak.	Y / N
Is air flow set and balanced?	Y / N		
Thermostat type:	BMS / SAT-3 / TZT-100 / Other? (name):		

Mark UC8 dip switch positions with an 'X'

	SW1							
	1	2	3	4	5	6	7	8
On								
Off								

	SW2							
	9 (1)	10 (2)	11 (3)	12 (4)	13 (5)	14 (6)	15 (7)	16 (8)
On								
Off								

Record the following UC8 monitored conditions using push button SW3 (repeat to scroll through list).

IMPORTANT: Digital compressors must be operating at 100% for at least 10 minutes when taking these readings.

		System 1	System 2	System 3	System 4			
COOLING CYCLE	Low Pressure:	SLP	kPa	kPa	kPa	kPa	Outdoor Ambient temperature:	°C
	Evap temperature:	Et	°C	°C	°C	°C	Indoor Return air temperature:	°C
	Suction Line temperature:	SLt	°C	°C	°C	°C	Indoor Supply air temperature:	°C
	Suction Superheat:	SSH	K	K	K	K	Indoor fan amps :	A
	Discharge Line Pressure:	dLP	kPa	kPa	kPa	kPa	Fresh Air introduced :	%
	Condensing temperature:	Ct	°C	°C	°C	°C	Compressor 1 amps :	A
	Discharge Line temperature:	dLt	°C	°C	°C	°C	Compressor 2 amps :	A
	Discharge Superheat:	dSH	K	K	K	K	Compressor 3 amps :	A
	De-ice Sensor temperature:	ICEt	°C	°C	°C	°C	Compressor 4 amps :	A
	Required Capacity:	CAP	%	%	%	%		
	Expansion Valve 1:	EE1	%	%	%	%		
	Expansion Valve 2:	EE2	%	%	%	%		

HEATING CYCLE	Low Pressure:	SLP	kPa	kPa	kPa	kPa	Outdoor Ambient temperature:	°C
	Evaporating temperature:	Et	°C	°C	°C	°C	Indoor Return air temperature:	°C
	Suction Line temperature:	SLt	°C	°C	°C	°C	Indoor Supply air temperature:	°C
	Suction Superheat:	SSH	K	K	K	K	Indoor fan amps :	A
	Discharge Line Pressure:	dLP	kPa	kPa	kPa	kPa	Fresh Air introduced :	%
	Condensing temperature:	Ct	°C	°C	°C	°C	Compressor 1 amps :	A
	Discharge Line temperature:	dLt	°C	°C	°C	°C	Compressor 2 amps :	A
	Discharge Superheat:	dSH	K	K	K	K	Compressor 3 amps :	A
	De-ice Sensor temperature:	ICEt	°C	°C	°C	°C	Compressor 4 amps :	A
	Required Capacity:	CAP	%	%	%	%		
	Expansion Valve 1:	EE1	%	%	%	%		
	Expansion Valve 2:	EE2	%	%	%	%		

NOTE: This document to be kept with the unit. Failure to provide this completed page on request by Temperzone may affect unit warranty.

www.temperzone.com

Auckland

Head Office

38 Tidal Rd, Mangere, Auckland
Private Bag 93303, Otahuhu
New Zealand

Phone: (09) 279 5250

Email: sales@temperzone.co.nz

Sydney

Head Office

14 Carnegie Place, Blacktown
NSW 2148
PO Box 8064, Seven Hills West
NSW 2147, Australia

Phone: (02) 8822 5700

Email: sales@temperzone.com.au

Newcastle

Phone: (02) 4692 1155

Email: sales@mcintoshair.com.au

Launceston

Phone: (03) 6331 4209

Email: info@hvac-supplies.net

Hamilton

Phone: (07) 839 2705

Email: tzhamilton@temperzone.com

Adelaide

Phone: (08) 8115 - 2111

Email: sasales@temperzone.com.au

Singapore

Phone: +65 6733 4292

Email: sales@temperzone.com.sg

Wellington

Phone: (04) 569 3262

Email: wgtn@temperzone.com

Melbourne

Phone: (03) 8769 7600

Email: vicsales@temperzone.com.au

Christchurch

Phone: (03) 379 3216

Email: chch@temperzone.com

Brisbane

Phone: (07) 3308 8333

Email: qldsales@temperzone.com.au

Perth

Phone: (08) 6399 5900

Email: reception@airskill.com.au



Materials and specifications are subject to change without notice due to the manufacturer's ongoing research and development programme.