

# SPECIFICATIONS



Model	HWP 59RKS
Item No. (Standard/Opposite Hand)	509-059-001 / 509-059-011
Cooling capacity (net) to AS/NZS 3823 T1	5.7 kW
Heating capacity H1	5.4 kW
Electrical input - cooling	1.6 kW
Electrical input - heating	1.5 kW
EER / AEER (cooling)	3.61 / 3.60
Unit Controller	UC8
Refrigerant	R410A
Refrigerant charge	1.05 kg
Compressor type	rotary
Water connections	1/2" male BSP
Nominal EWT/EAT on cooling	30°C / 27°C db, 19°C wb
Nominal EWT/EAT on heating	20°C / 20°C
Nominal Water Flow @ EWT – LWT = 5k	0.34 l/s
Entering system pressure drop @ nominal flow	41 kPa (6 psi)
Min. water temp. Heat cycle at nominal flow & EAT	10°C
Min. water temp. Cool cycle at nominal flow & EAT	15°C
Min. water temp. Cool cycle with water flow control valve	5°C
Max. EWT Heat cycle at nominal flow & EAT	30°C
Max. EWT Cool cycle at nominal flow & EAT	50°C
Min. water flow @ nominal EWT & EAT	0.09 l/s
Max. water pressure – excluding hoses	3200 kPa (464 psi)
Power supply	1 ph. 230V ac 50Hz
Compressor run amps at rating cond.	6.6 A
Compressor run capacitor	40 $\mu$ fd
Indoor fan motor size	230 W
Indoor fan motor (1ph.) - full load	1.9 A
Control circuit breaker (internal)	10 A
Running amps (total system)	7.6 A
Max. running amps (total system)	11.2 A
Net weight	85 kg

## Accessories:

Spring mounts	supplied
Water hoses 600mm long, rated 250psi	1/2" female BSP, supplied
Replacement filter	119-000-086 840x265x13
Condensate lift-pump	507-003-009

## Optional:

SAT-3 Room temperature controller	201-000-146
TZT-100 Room temperature controller	201-000-350

Refer to temperzone for other options, eg remote sensors

# DIMENSIONS (mm)



Not to Scale

## HWP 59RKS Standard

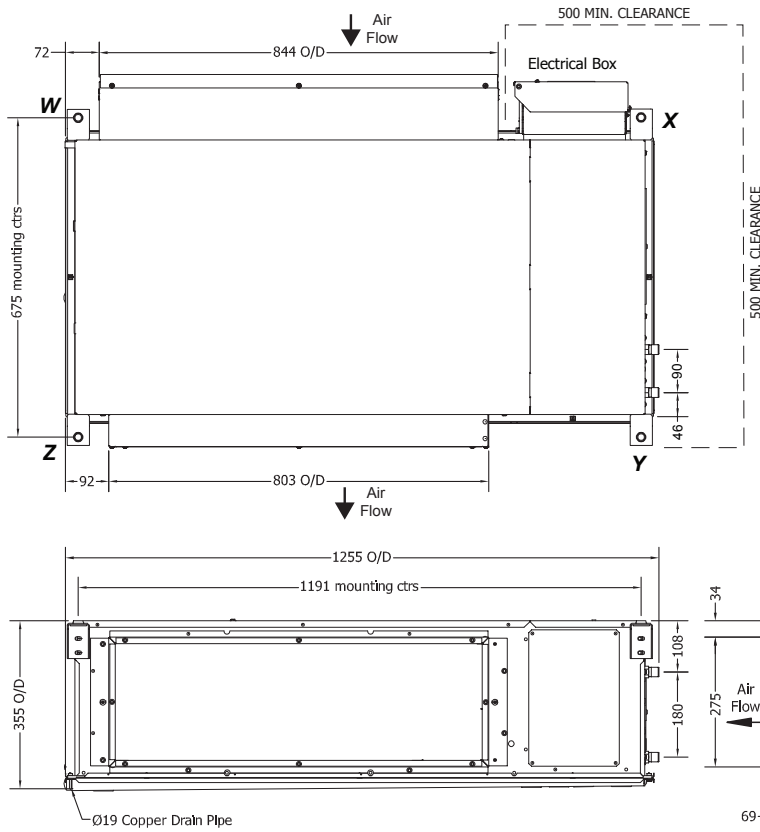

POINT LOADS (kg)			
W	X	Y	Z
21	26	23	15

**Note:** Fan motor can be accessed from panel above, below or sides; no more than two panels at once.

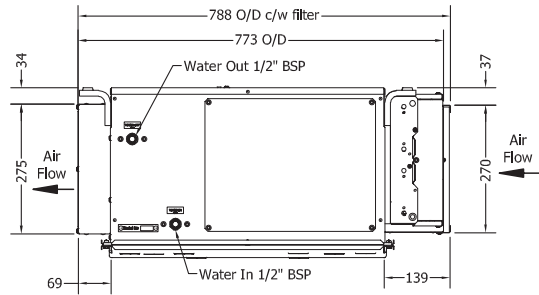

## HWP 59RKS Opposite Hand

POINT LOADS (kg)			
W	X	Y	Z
26	15	21	23

**Note:** Fan motor can be accessed from panel above, below or sides; no more than two panels at once.

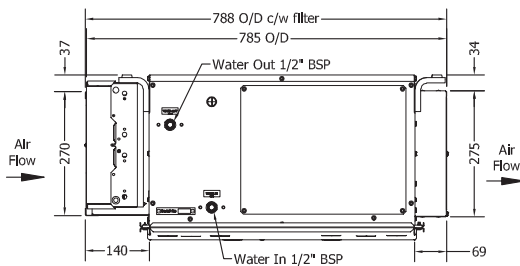
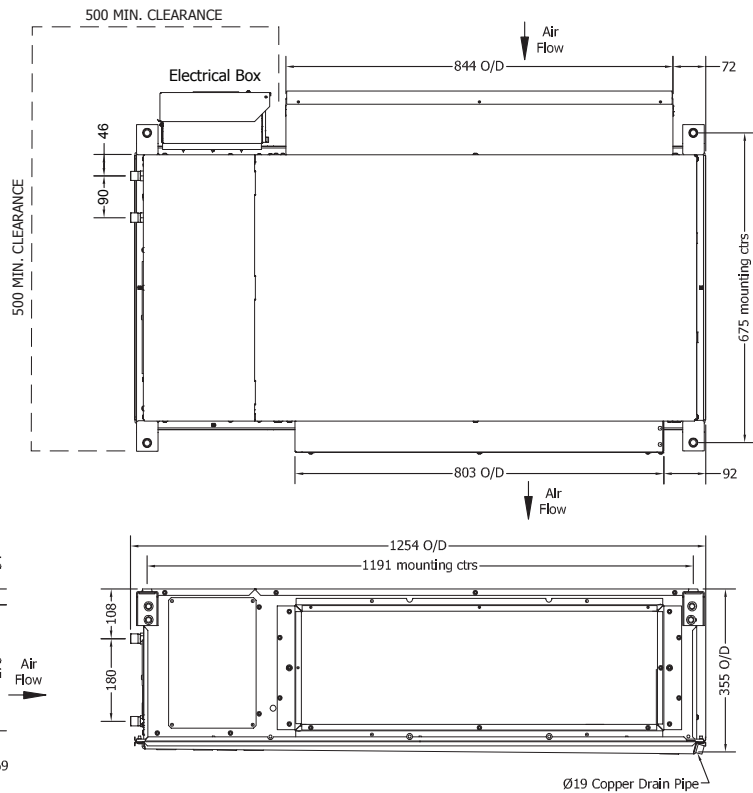

### NOTE

Specifications are subject to change without notice due to the manufacturer's ongoing research and development programme.

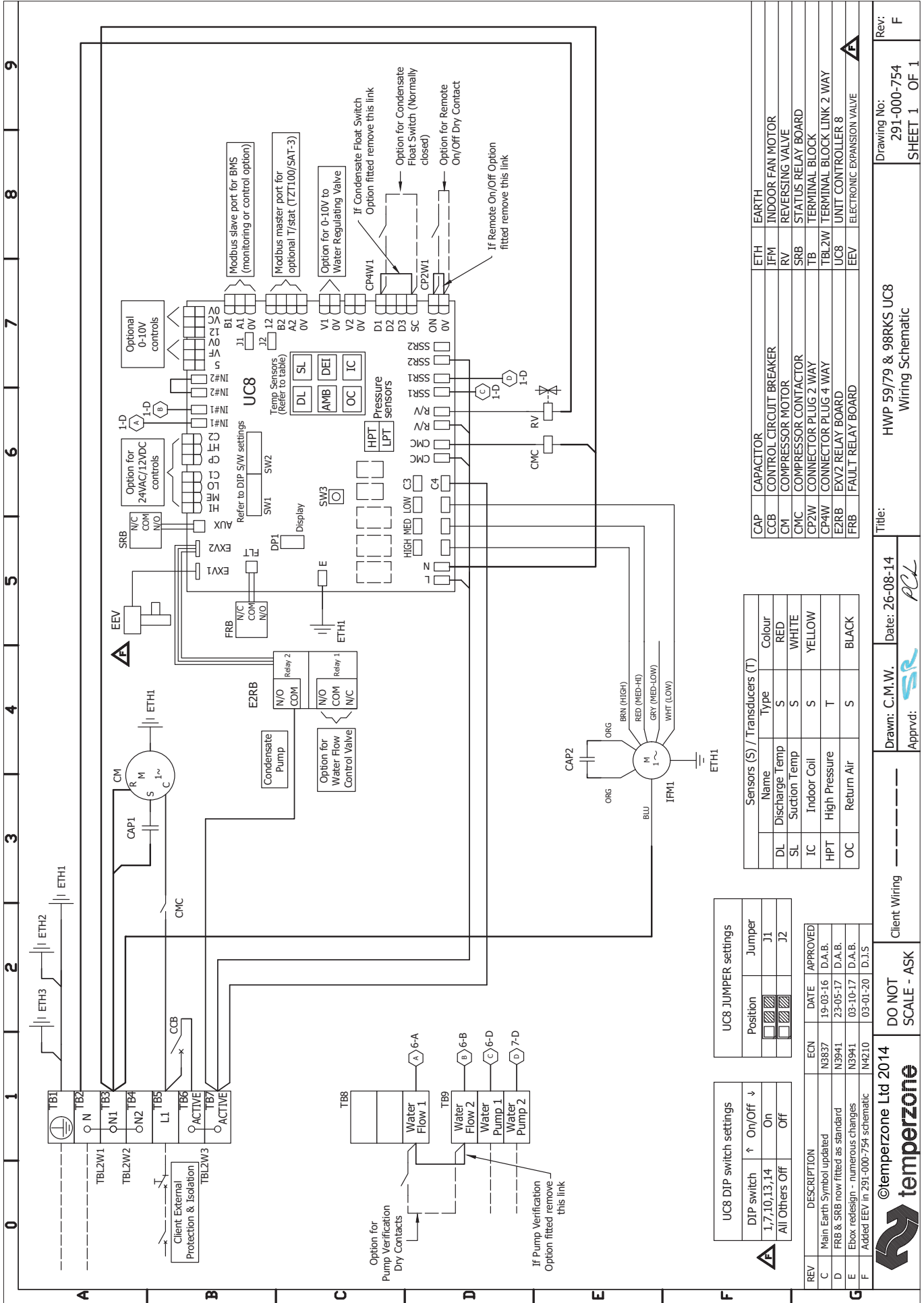

**UC8 DIP switch settings**

DIP switch	On/Off
1,7,10,13,14	On
All Others	Off

**UC8 JUMPER settings**

Position	Jumper
1	J1
2	J2

REV	DESCRIPTION	ECN	DATE	APPROVED
C	Main Earth Symbol updated	N3837	19-03-16	D.A.B.
D	FRB & SRB now fitted as standard	N3941	23-05-17	D.A.B.
E	Ebox redesign - numerous changes	N3941	03-10-17	D.A.B.
F	Added EEV in 291-000-754 schematic	N4210	03-01-20	D.J.S

**Sensors (S) / Transducers (T)**

Name	Type	Colour
DL Discharge Temp	S	RED
SL Suction Temp	S	WHITE
IC Indoor Coil	S	YELLOW
HPT High Pressure	T	
OC Return Air	S	BLACK

CAP	CAPACITOR	ETH	EARTH
CCB	CONTROL CIRCUIT BREAKER	IFM	INDOOR FAN MOTOR
CM	COMPRESSOR MOTOR	RV	REVERSING VALVE
CMC	COMPRESSOR CONTACTOR	SRB	STATUS RELAY BOARD
CP2W	CONNECTOR PLUG 2 WAY	TB	TERMINAL BLOCK
CP4W	CONNECTOR PLUG 4 WAY	TBL2W	TERMINAL BLOCK LINK 2 WAY
E2RB	EXV2 RELAY BOARD	UC8	UNIT CONTROLLER 8
FRB	FAULT RELAY BOARD	EEV	ELECTRONIC EXPANSION VALVE

©temperzone Ltd 2014

**temperzone**

DO NOT SCALE - ASK

Client Wiring

Drawn: C.M.W. Date: 26-08-14

Approved: *PCL*

Title: HWP 59/79 & 98RKS UC8 Wiring Schematic

Rev: 291-000-754 SHEET 1 OF 1



# SPECIFICATIONS



Model	HWP 59CKS	HWP 59CEKS
Item No. - Standard	509-059-101	509-059-102
Item No. - Opposite Hand	509-059-111	509-059-112
Cooling capacity (net) to AS/NZS 3823 T1	5.7 kW	
Heating capacity - Electric heat	n/a	3.0 kW
Electrical input - cooling	1.5 kW	
Electrical input - heating	n/a	3.2 kW
EER / AEER (cooling)	3.61 / 3.60	
Unit Controller	UC8	
Refrigerant	R410A	
Refrigerant charge	0.73 kg	
Compressor type	rotary	
Water connections	1/2" male BSP	
Nominal EWT on cooling	30°C	
Nominal EAT on cooling	27°C db, 19°C wb	
Nominal Water Flow @ EWT – LWT = 5k	0.34 l/s	
Entering system pressure drop @ nominal flow	41 kPa (6 psi)	
Min. water temp. Cool cycle at nominal flow & EAT	15°C	
Min. water temp. Cool cycle with water flow control valve	5°C	
Max. EWT Cool cycle at nominal flow & EAT	50°C	
Min. water flow @ nominal EWT & EAT	0.09 l/s	
Max. water pressure – excluding hoses	3200 kPa (464 psi)	
Power supply	1 ph. 230V ac 50Hz	
Compressor run amps at rating cond.	6.0 A	
Compressor run capacitor	40 µfd	
Indoor fan motor size	230 W	
Indoor fan motor (1ph.) - full load	1.9 A	
Control circuit breaker (internal)	10 A	
Running amps (total system)	7.6 A	14.1 A
Max. running amps (total system)	11.2 A	14.9 A
Net weight	85 kg	86 kg

### Accessories:

Spring mounts	supplied
Water hoses 600mm long, rated 250psi	1/2" female BSP, supplied
Replacement filter - rated EU2/G2	119-000-086 840x265x13
Condensate lift-pump	507-003-009

### Optional:

SAT-3 Room temperature controller	201-000-146
TZT-100 Room temperature controller	201-000-350

Refer to temperzone for other options, eg remote sensors

# DIMENSIONS (mm)

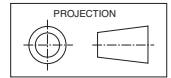

Not to Scale

## HWP 59 CKS/CEKS Standard

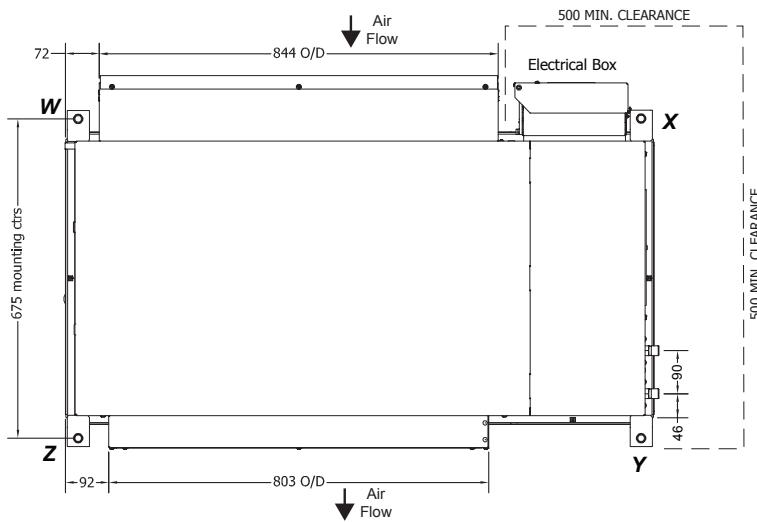

POINT LOADS (kg)			
W	X	Y	Z
21	26	23	15

**Note:** Fan motor can be accessed from panel above, below or sides; no more than two panels at once.

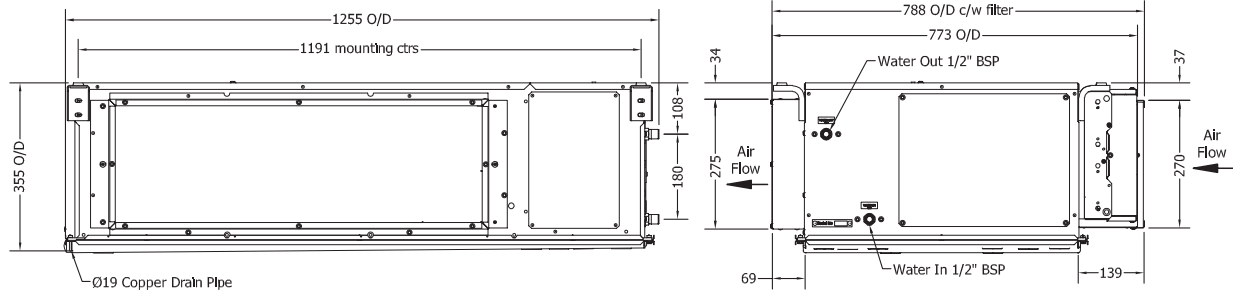

## HWP 59 CKS/CEKS Opposite Hand

POINT LOADS (kg)			
W	X	Y	Z
26	15	21	23

**Note:** Fan motor can be accessed from panel above, below or sides; no more than two panels at once.

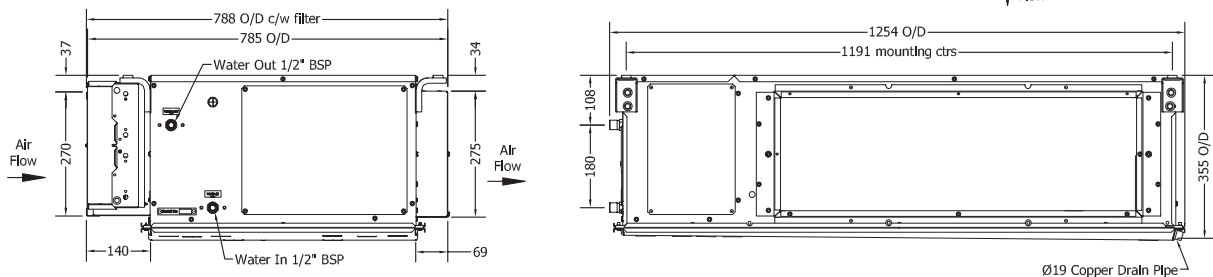
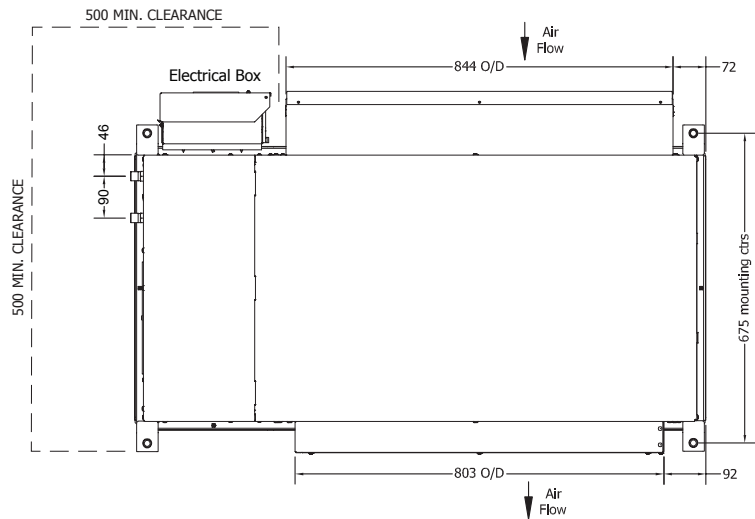

### NOTE

Specifications are subject to change without notice due to the manufacturer's ongoing research and development programme.

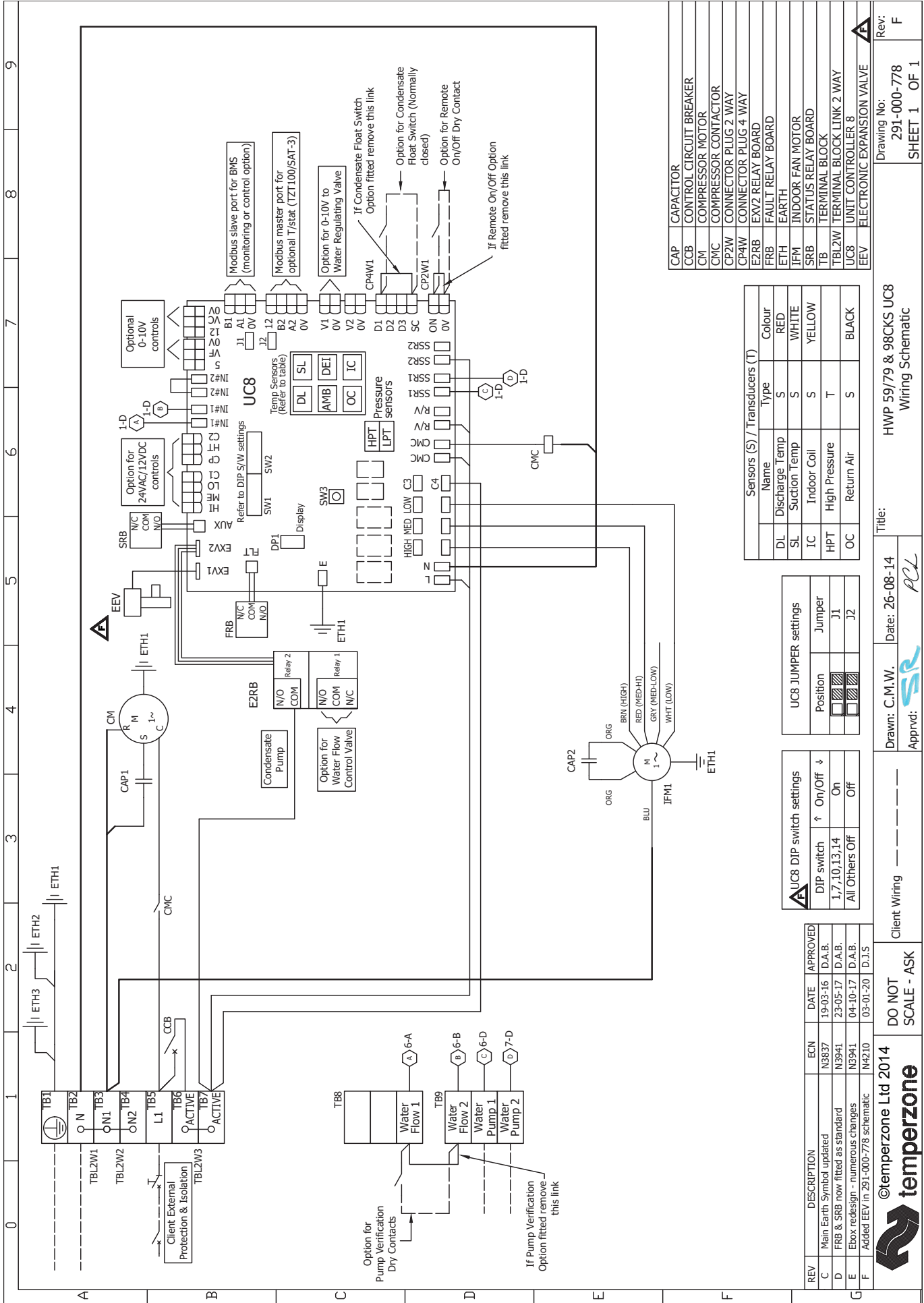

0 1 2 3 4 5 6 7 8 9

A B C D E F

CAP	CAPACITOR
CCB	CONTROL CIRCUIT BREAKER
CM	COMPRESSOR MOTOR
CMC	COMPRESSOR CONTACTOR
CP2W	CONNECTOR PLUG 2 WAY
CP4W	CONNECTOR PLUG 4 WAY
E2RB	EXV2 RELAY BOARD
FRB	FAULT RELAY BOARD
ETH	EARTH
IFM1	INDOOR FAN MOTOR
SRB	STATUS RELAY BOARD
TB	TERMINAL BLOCK
TBL2W1	TERMINAL BLOCK LINK 2 WAY
UC8	UNIT CONTROLLER 8
EEV	ELECTRONIC EXPANSION VALVE

Sensors (S) / Transducers (T)		
Name	Type	Colour
DL	Discharge Temp	RED
SL	Suction Temp	WHITE
IC	Indoor Coil	YELLOW
HPT	High Pressure	T
OC	Return Air	BLACK

UC8 JUMPER settings		
Position	Jumper	
1	J1	
2	J2	

UC8 DIP switch settings		
DIP switch	On/Off	↓
1,7,10,13,14	On	
All Others Off	Off	

REV	DESCRIPTION	ECN	DATE	APPROVED
C	Main Earth Symbol updated	N3837	19-03-16	D.A.B.
D	FRB & SRB now fitted as standard	N3941	23-05-17	D.A.B.
E	Ebox redesign - numerous changes	N3941	04-10-17	D.A.B.
F	Added EEV in 291-000-778 schematic	N4210	03-01-20	D.J.S

**temperzone** Ltd 2014  
 Client Wiring   
 DO NOT SCALE - ASK  
 Drawn: C.M.W. Date: 26-08-14  
 Approved:  *ACL*  
 Title: HWP 59/79 & 98CK5 UC8 Wiring Schematic  
 Drawing No: 291-000-778  
 Rev: F  
 SHEET 1 OF 1

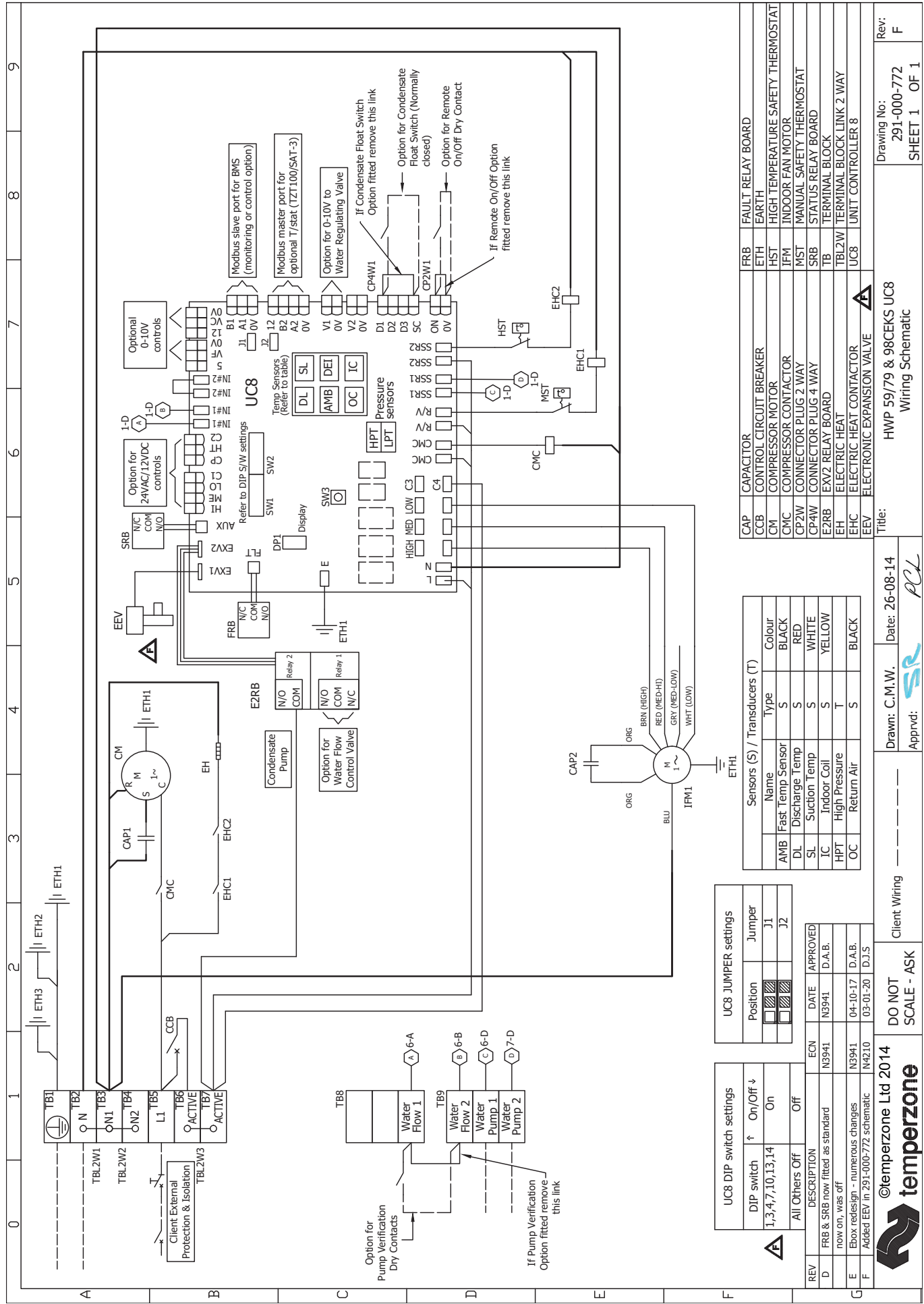

REV	DESCRIPTION	ECN	DATE	APPROVED
D	FRB & SRB now fitted as standard now on, was off	N3941	N3941	D.A.B.
E	Ebox redesign - numerous changes	N3941	04-10-17	D.A.B.
F	Added EEV in 291-000-772 schematic	N4210	03-01-20	D.J.S.

UC8 DIP switch settings	
DIP switch 1,3,4,7,10,13,14	On
All Others Off	Off

UC8 JUMPER settings	
Position	Jumper
<input type="checkbox"/>	J1
<input type="checkbox"/>	J2

Sensors (S) / Transducers (T)		
Name	Type	Colour
AMB	Fast Temp Sensor	BLACK
DL	Discharge Temp	RED
SL	Suction Temp	WHITE
IC	Indoor Coil	YELLOW
HPT	High Pressure	T
OC	Return Air	BLACK

UC8 RELAY BOARD	
CAP	CAPACITOR
CCB	CONTROL CIRCUIT BREAKER
CM	COMPRESSOR MOTOR
CMC	COMPRESSOR CONTACTOR
CP2W	CONNECTOR PLUG 2 WAY
CP4W	CONNECTOR PLUG 4 WAY
E2RB	EX2Z RELAY BOARD
EH	ELECTRIC HEAT
EHC	ELECTRIC HEAT CONTACTOR
EEV	ELECTRIC EXPANSION VALVE
FRB	FAULT RELAY BOARD
ETH	EARTH
HST	HIGH TEMPERATURE SAFETY THERMOSTAT
IFM	INDOOR FAN MOTOR
MST	MANUAL SAFETY THERMOSTAT
SRB	STATUS RELAY BOARD
TB	TERMINAL BLOCK
TBL2W	TERMINAL BLOCK LINK 2 WAY
UC8	UNIT CONTROLLER 8



Client Wiring  
DO NOT SCALE - ASK

Drawn: C.M.W. Date: 26-08-14  
Apprvd: *SR*

Title: HWP 59/79 & 98CEKS UC8 Wiring Schematic  
Drawing No: 291-000-772 SHEET 1 OF 1  
Rev: F