

Wiring and Piping Guide

Wall & Floor Mounted Split Systems

HITACHI

Wiring Detail

Model	Power Supply to	Power Supply	Recommended External Breaker	Interconnecting Wire*	Diagram
RAS/RAC-25YHA5	ODU	230V 1ph	15A	1.5mm 3 core + E	2
RAS/RAC-35YHA6	ODU	230V 1ph	15A	1.5mm 3 core + E	2
RAS/RAC-50YHA4	ODU	230V 1ph	16A	1.5mm 3 core + E	2
RAS/RAC-60YHA4	ODU	230V 1ph	20A	1.5mm 3 core + E	2
RAS/RAC-70YHA4	ODU	230V 1ph	20A	1.5mm 3 core + E	2
RAS/RAC-80YHA4	ODU	230V 1ph	20A	1.5mm 3 core + E	2
RAF/RAC-35NXA1	ODU	230V 1ph	16A	1.5mm 2 core + E	1
RAF/RAC-50NXA1	ODU	230V 1ph	16A	1.5mm 2 core + E	1

Diagram 1.

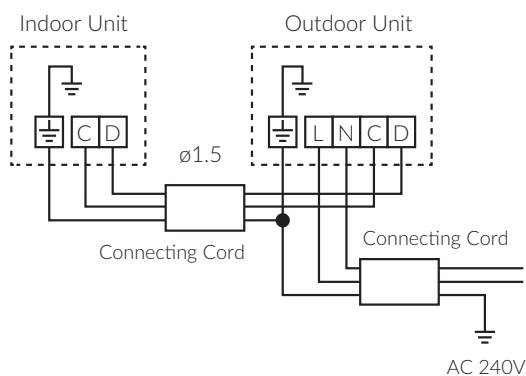
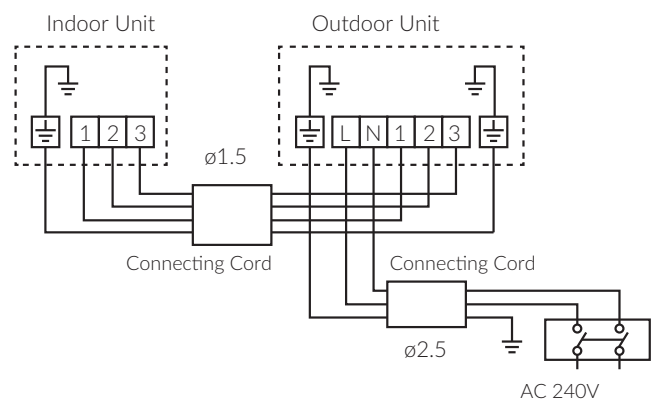

Diagram 2.



Piping Detail

Model	Pipe Sizes (mm)	Max /Min Pipe Length	Pre-charged length	Additional Charge	Max Height Difference IU to OU
RAS/RAC-25YHA5	6.4 / 9.5	2m / 20m	20m	n/a	10m
RAS/RAC-35YHA6	6.4 / 9.5	2m / 20m	20m	n/a	10m
RAS/RAC-50YHA4	6.4 / 12.7	3m / 30m	30m	n/a	10m
RAS/RAC-60YHA4	6.4 / 12.7	3m / 30m	20m	>20m = 10g/m	20m
RAS/RAC-70YHA4	6.4 / 15.9	3m / 30m	30m	n/a	20m
RAS/RAC-80YHA4	6.4 / 15.9	3m / 30m	30m	n/a	20m
RAF/RAC-35NXA1	6.4 / 9.5	3m / 20m	20m	n/a	10m
RAF/RAC-50NXA1	6.4 / 12.7	3m / 20m	20m	n/a	10m