

HWP 35, 47, 58 (c/w EC Motor)

Ducted Water Cooled R410A Packaged Air Conditioner

Installation & Maintenance

Fig. 1 Nomenclature

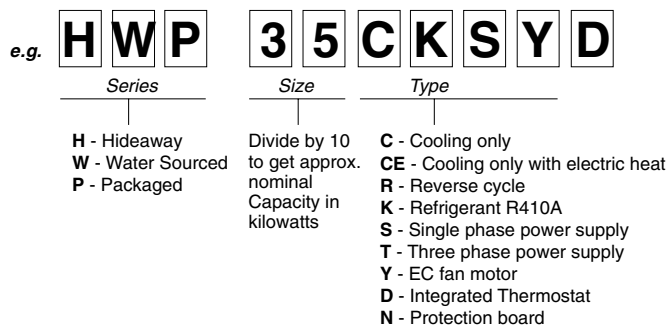

GENERAL

HWP - A general designation which applies to all versions (refer fig.1)

These HWP units must be installed in accordance with all national and local safety codes.

OPTIONS

The following items are available as optional extras:

1. Condensate Lift-Pump Kit.
2. Filter Box.

High pressure hoses (600 mm long) c/w fitting and spring mounts are supplied as standard.

Fig. 2 Dimensions (mm)

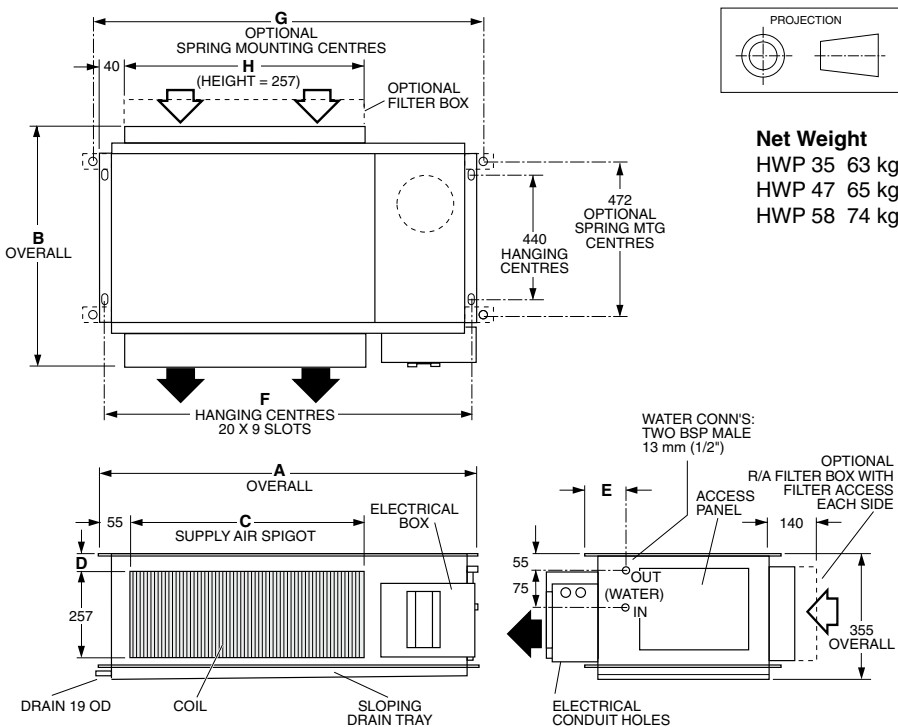

MODEL	A	B	C	D	E	F	G	H
HWP 35	845	705	477	40	105	825	900	480
HWP 47	845	725	477	40	105	825	900	480
HWP 58	1110	705	742	45	90	1090	1165	745

AIR FILTRATION / FILTER BOX (Option)

As air filtration requirements vary, filters are not supplied with the unit. Filters should ideally be installed on the return air side of the unit, no closer than 500 mm from the back of the unit and easily accessible for cleaning. To maximise the efficiency of air flow, the return air filter should be twice the area of the HWP unit's return air spigot/s. If efficiency is less of a concern a Filter Box is available.

The Filter Box is installed by unscrewing the return air spigot and replacing it with the Filter Box's filter-integrated spigot. The filter may be accessed from either side of this spigot. This box adds 90 mm to the overall depth of the unit.

RETURN AIR SPIGOT

For ease of shipping the return air spigot is supplied reversed. Unscrew this spigot and rescrew to the unit the opposite way around prior to installing the HWP unit.

INSTALLATION

Positioning & Mounting

HWP units are designed to be used with simple, short duct layouts. Units should be located as close to the space to be air conditioned as acoustic criteria allows; refer to Fig. 6 for application considerations.

When determining the position of the air conditioner, allow adequate space around the unit to facilitate future servicing and maintenance. Ensure there is enough working space in front of the electrical access panel. Allow adequate clearance for the filter (optional) to be withdrawn to its full length.

It is recommended that the unit be mounted using the spring mount system supplied (Fig.3). This system minimises transfer of vibration into the building structure.

If a more rigid installation can be tolerated, then suspend the unit from four threaded rods using locknuts (not supplied), as shown in Fig. 4.

Mount the unit level as it comes with a sloping drain tray. This tray is reversible – but not if using the optional condensate lift-pump; then the drain exit can only be at the opposite end to the compressor.

The drain line must have a slope of at least 1 in 50 and must not be piped to a level above the drain tray. Where required a condensate lift-pump should be used (optional extra).

When finally positioned, tighten the lock nuts on the mounting rods to give a firm installation (see Fig. 4).

Fig. 3 Spring Mounting

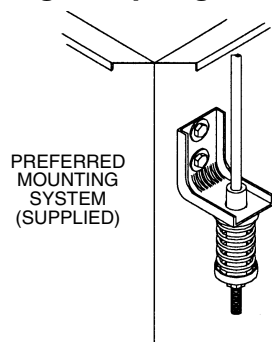
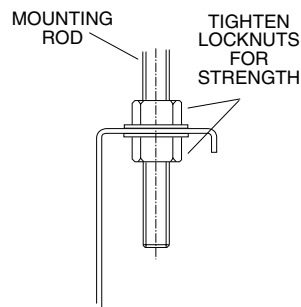

Fig. 4 Solid Mounting



Condensate Drain

The condensate drain is **not** to be trapped outside the unit. The drain line must be maintained at least 19 mm ID along its full length. Fit a vent pipe within 500 mm of the unit, 300 mm high and 10 mm ID (minimum); see Fig. 5. Check drain by pouring water into the drain tray and ensuring that it clears. Failure to adhere to these instructions could cause flooding.

Fig. 5 Condensate Drain

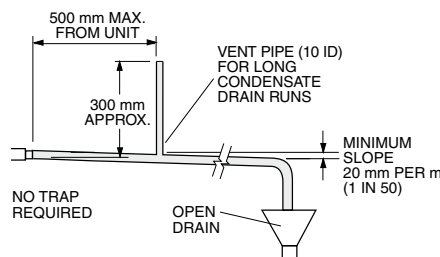

Water Supply & Return

The HWP unit's IN and OUT water connections are male pipe threaded (refer Fig. 1). The two **temperzone** 600 mm flexible high pressure water hoses supplied have female pipe threaded connections at each end. Maximum water pressure for each hose is 1720 kPa (250 psi). The HWP unit alone, excluding hoses, will withstand 4480 kPa (650 psi).

Poor quality water supply must be pre-filtered and it is essential that adequate water treatment is maintained, particularly where open cooling towers are used.

Note: It is required that the water supply system be fitted with a water flow switch and water pump safety interlock. These items prevent the HWP units from going into fail safe lockout status due to a loss of water flow. Failure to install the above items would require the resetting of all HWP units in the system - either by breaking the power supply to each unit or breaking the thermostat control circuit.

HWP*R units require a minimum water supply temperature of 17°C.

Circuit Balancing Valve

It is recommended that a circuit balancing valve be fitted to maintain water flow at a constant rate. The minimum water flow rates in litres per second (l/s) are as follows:

HWP:	35	47	58
Minimum	0.17	0.27	0.36

Electrical

The air conditioner should be connected to the appropriate power supply for each model, as specified in the wiring diagram, with neutral and adequate earth. The supply to have an accessible switch to allow isolation of the unit. Wire the heating and cooling room thermostat to the electrical terminals adhering to the wiring diagram supplied with the unit. All wiring to the air conditioner must comply with the wiring regulations of the local electrical authority.

Indoor Fan Speed

The fan speed (RPM) range is adjustable using DIP2 Switches 1 to 5 on the EC Motor Controller board located in the electrical box – refer wiring diagram. The default setting is highlighted.

HWP-CKSYN & HWP-RKSYN models:

Once set, your fan speed range can then be set to:

1. *Variable:* Anywhere from 0–100% capacity (max. RPM) using a 0–10V DC input signal supplied from an independent BMS. (DIP1 switch 1 'ON'), or
2. *Stepped:* LOW, MED and HIGH (DIP1 switch 1 'OFF') across the selected range.

Note: If using Option 1-Variable, then you must also fit an Controller Signal Isolator (item no.201-000-129), supplied separately by temperzone.

HWP-CKSYD & HWP-RKSYD models:

Once set, your fan speed range can then be set to: LOW, MED and HIGH (DIP1 switch 1 'OFF') across the selected range.

Air / Water Flow

Refer to HWP 35–58 Data Sheet pamphlets for detailed information on air handling performance and water flow rates.

Unit Protection

Unit protection is incorporated in either:

- a.) HWP Protection Board, or
- b.) SAT-2 Controller, depending on which HWP model is being installed.

A pump verification relay ensures that water is flowing before the compressor will start. A high pressure lockout protects the unit from low water flow in cooling mode, or fan failure in heating mode. Sensors protect against low air coil temperature and loss of refrigerant. Units include an anti rapid cycle device for compressor protection.

HWP*R units also have a low refrigerant temp. safety thermostat to protect against icing up of the water within the unit's tube-in-tube heat exchanger.

A non-specific fault LED/ output signal is also included for remote fault indication to building management systems (refer wiring).

Note: Lockout protection can be reset by switching unit's power supply off and on. Lockout protection will also reset when the thermostat switches, or is switched to the dead zone.

Units Supplied With SAT-2 Thermostat

Any faults detected are displayed on the SAT-2 Wall plaque (refer Table 1). A non-specific fault output signal is also included on SAT-2 Controllers for remote fault indication to building management systems.

Units Supplied With Electric Heat

HWP*CEKS models supplied with electric heat include both auto (90°C) and manual (120°C) high temp. safety thermostats. If the manual safety t/stat requires resetting, then the auto safety t/stat has failed and needs to be replaced.

Room Thermostat

(Reverse Cycle Models)

The thermostat should be set within the recommended operating range of between 19°C and 30°C. The thermostat should not be used as an on-off switch. Refer to **temperzone** for a list of other approved thermostats.

If your unit is supplied with **temperzone's SAT-2 Thermostat**, refer to page 3 for installation instructions.

COMMISSIONING

1. Check that the thermostat is correctly wired and set at the desired temperature.
2. Check that the air filter (if fitted) is clean.
3. Check that the fan runs freely without vibration.
4. Check condensate drain and safety drain tray for free drainage.

Demonstrate the SAT-2 Wall Control (if supplied) to the owner/user, after having first thoroughly familiarised yourself with the

User's Operating Instructions. This page is to remain with the owner/user.

MAINTENANCE

Quarterly

1. Remove lint and dust accumulation from heat exchange air coil. (Note: failure to do this may affect efficiency).

2. Check air filters and vacuum or wash clean as necessary.
3. Check condensate drain for free drainage.
4. Check compressor compartment for oil stains indicating refrigerant leaks.
5. Check quality of water supply.

Six Monthly

Check tightness of electrical connections.

Yearly

1. Remove lint and dust accumulation from heat exchange air coil. (Note: failure to do this may affect efficiency).
2. Replace air filter if damaged to maintain adequate air flow and efficiency.

Units Supplied With Integrated Thermostat (SAT-2 Controller)

Components

The following components are supplied in a box taped inside the supply air spigot:

1. SAT-2 Wall Control plaque, including wall mounting plate.
2. 10 m interface lead (electrical box-to-plaque).
3. User's Operating Instructions booklet.
4. Lithium CR2032 battery (3V).

Optional

1. Remote return air sensor (in box).
2. Remote return air temperature sensor lead; 1.5, 6, 12 or 25 m.
3. 20 m extended interface lead (electrical box-to-plaque).
4. SAT-2 Zone Control PCB.
5. Zone Control 24V transformer.
6. Additional SAT-2 Wall Control plaque.
7. Infra red remote control.

Installation

The SAT-2 Controller PCB is supplied pre-installed in the HWP unit's electrical box.

1. Isolate the HWP unit from power supply, then remove electrical box cover.
2. Remove the SAT-2 box supplied taped inside the supply air spigot.
3. Remove the Wall Control's interface lead from this box and connect to the terminal block (A1/B1/Vcc/GND) on the SAT-2 Controller board. Trace the remaining length of the lead to the Wall Control's intended location. **Note:** Make sure the coloured wires are connected as per the wiring diagram.
4. Remove the Wall Control's backing plate by using a small screw driver to remove the single screw at the bottom edge of the plaque.
5. Install the Lithium battery, supplied loose, positive (+) side up in the Wall Control's battery holder.
6. Check the wall where the Wall Control plaque is to be located is flat before fastening the wall mounting plate. Alternatively, the mounting plate can be screwed to a standard wall socket mounted horizontally. **Note:** Use low profile (mush) headed screws to prevent contact with the PCB board. Fixing the plate to a distorted surface may damage the control.
7. Drill hole in wall to allow cable entry.
8. Connect the interface lead to the the Wall Control board. **Note:** Make sure the coloured wires are consistently connected at each end as per the wiring diagram.
9. Ensure the interface lead is run separately and away from main power supply wires, including the interconnecting cable. When installing cabling, trim any excess length to suit your location.

10. Fill around the interface lead with foam or cover hole with PVC tape to prevent draft from wall cavity affecting control operation. Do not use aluminium duct tape.
11. Secure the Wall Control body to the mounting plate by replacing the locking screw removed earlier.
12. Replace the HWP electrical box cover.

Remote Air Temperature Sensor/s (option)

The air temperature sensor is by default located in the Wall plaque. Optional remote air temperature sensors are available so that the measurement of the room temperature can be taken away from the wall plaque, eg. elsewhere in the room or in the return air duct.

Remote sensor's can be plugged directly into the Controller board (PCB). This board accepts up to four sensors which are designated as 'zones' one to four. The first return air sensor will automatically replace the Wall Control sensor and should be located in the same room as the Wall Control. The Controller will always use the average of the zones selected. Refer to the separate installation instructions supplied with the PCB for further details.

Ensure all remote sensor wires are run separately and away from main power supply wires, including the interconnecting cable.

Fault Detection

Any faults detected are displayed on the SAT-2 Wall plaque (refer Table 1). A non-specific fault output signal is also included on SAT-2 Controllers for remote fault indication to building management systems.

NOTE

The manufacturer reserves the right to make changes in specifications at any time without notice or obligation. Certified data is available on request.

This pamphlet replaces the previous issue no. 3531 dated 07/12.
Wiring revisions B, A, B, B & B resp.

Table 1 SAT-2 Controller - Troubleshooting

If a fault is detected, an 'ERR' symbol will light up on the Wall plaque display. The following error codes may be displayed:

Error Code	Fault	Remarks
1	Room sensor #1 failure	Main board AD3
2	Room sensor #2 failure	Main board AD4
3	Room sensor #3 failure	Main board AD5
4	Room sensor #4 failure	Main board AD6
5	#1 indoor coil sensor failure	Main board AD1
6	#1 LST sensor failure	Main board AD2
7	#1 insufficient refrigerant	
8	#1 compressor overload	
9	#1 low pressure failure	
10	#1 high pressure failure	
11	Room sensor #5 failure	At wallpad B
12	Room sensor #6 failure	At wallpad A
13	All room sensor failure	
14	Float switch failure	
15	#1 Low safety thermostat failure	
16	Communication failure	
17	Hydronic pump switch failure	
18	#2 insufficient refrigerant	
19	#2 compressor overload	
20	#2 Low safety thermostat failure	
21	Discharge sensor 1 failure	
22	Discharge sensor 2 failure	
23	Discharge temp 1 failure	
24	Discharge temp 2 failure	

Fig. 6 Application Considerations

Recommendations for Noise Isolation:

1. Avoid installing units, with non-ducted return air, directly above spaces where noise is critical.
2. Use flexible connections between unit and rigid ducting.
3. Use generously sized acoustically lined ducts.
4. If generous duct size is not possible, use turning vanes on bends to reduce air turbulence (regenerated noise).
5. Use 90° bends in ducting to significantly assist in noise reduction.

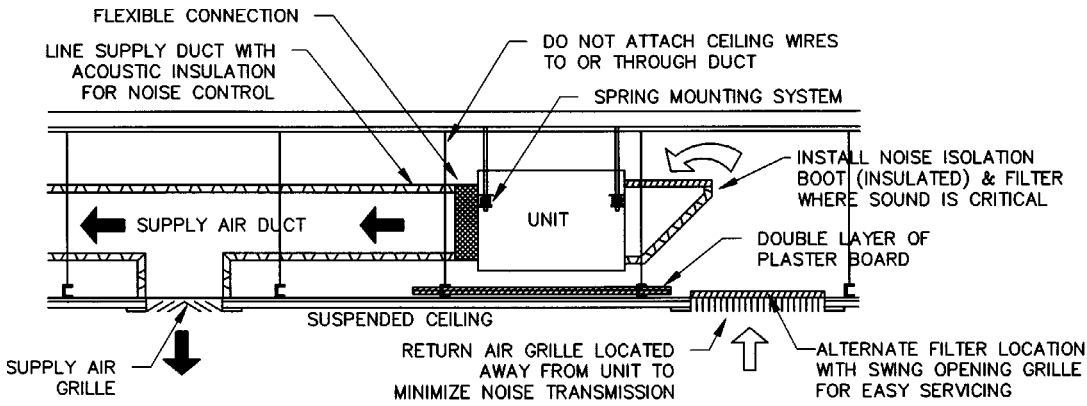
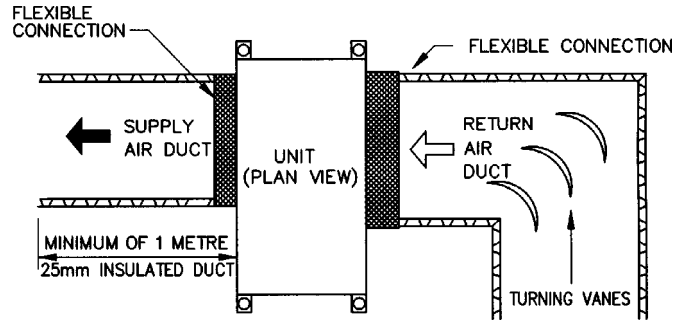

HWP 35-58 CKSYD

SPECIFICATION TABLE		HWP	HWP	HWP
CAPACITIES - AS/NZS 3823		35C	47C	58C
COOLING - NET		3.37	4.41	5.54
ELECTRICAL INPUT				
COOLING - kW/TRA		0.94/4.1	1.22/5.4	1.57/7.5
E.E.R. (COOLING)		3.58	3.61	3.53
A.E.E.R. (COOLING)		3.55	3.59	3.50
ELECTRICAL				
SUPPLY REQUIRED 1Ph, 200-252V ~ 50Hz INCLUDING VOLTAGE FLUCTUATION LIMITS				
COMPRESSOR RUN AMPS AT RATING		A 3.75	4.92	7.05
COMPRESSOR CAPACITOR SIZE		ufd 30	40	40
RATING AMPS		A 4.1	5.38	7.2
MAX RUNNING AMPS (TOTAL)		A 6.7	8.2	9.4
REFRIGERANT - R410A		kg 620	800	880
WEIGHT - NET		kg 63	65	74
COMPRESSOR TYPE: ROTARY				
OIL TYPE: PVE				

SAT 2 BOARD DEFINITIONS	
GUT1	4-WAY VALVE
GUT2	HEATER
GUT3	SWING/COMP2
GUT4	DRAIN PUMP
GUT5	POWER IN
GUT6	ZONE/MOTOR
RELAY1	FAULT RELAY
RELAY2	ZONE CONTROL BOARD
COM	COMMON
DIP6	HP SWITCH
DIP5	LP SWITCH
DIP4	FLOAT SWITCH
DIP3	HYDRONIC PUMP
DIP2	NO FUNCTION
DIP1	SD
A08	DISCHARGE 2
A07	DISCHARGE 1
A06	RETURN AIR 4
A05	RETURN AIR 3/INDOOR COIL 2
A04	RETURN AIR 2/LST
A03	RETURN AIR 1
A02	LST 1
A01	INDOOR COIL 1
SEC	TRANSFORMER SECONDARY
PRI	TRANSFORMER PRIMARY

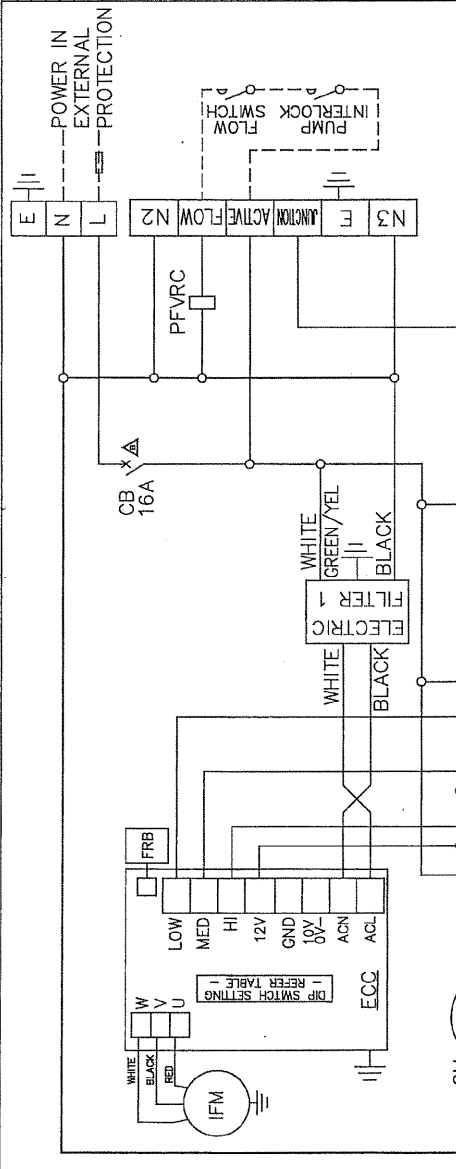

EC-BOARD SPEED SELECTION - DIP SWITCH 2 (DIP2)							
SWITCH 1	OFF	OFF	OFF	OFF	OFF	OFF	OFF
SWITCH 2	OFF	ON	OFF	ON	OFF	ON	OFF
SWITCH 3	OFF	OFF	ON	OFF	ON	OFF	ON
SWITCH 4	OFF	OFF	OFF	OFF	ON	ON	ON
SWITCH 5	OFF	OFF	OFF	OFF	OFF	OFF	OFF
Max (rpm)	1500	1400	1350	1300	1200	1100	DO NOT USE
Min (rpm)	1200	1000	1050	1000	850	800	DO NOT USE
Model HWP							35/47

STANDARD SETTING	
1	OFF
2	ON
3	ON
4	ON

STANDARD SETTING	
1	OFF
2	ON
3	ON
4	ON
5	ON
6	ON
7	ON
8	ON

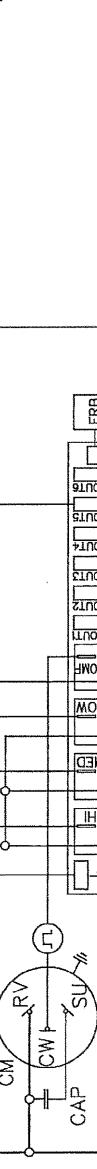

CLIENT WIRING	
CAP	CAPACITOR
CB	CIRCUIT BREAKER
CM	COMPRESSOR MOTOR
ECC	EC MOTOR CONTROLLER
FRB	FAULT RELAY BOARD
HP	HIGH PRESSURE CONTROL
IFM	INDOOR FAN MOTOR
PFVRC	PUMP FLOW VERIFICATION RELAY
PVR	PUMP FLOW VERIFICATION RELAY COIL
SDC	SHUT DOWN CONTROL
TRA	TOTAL RUNNING AMPS

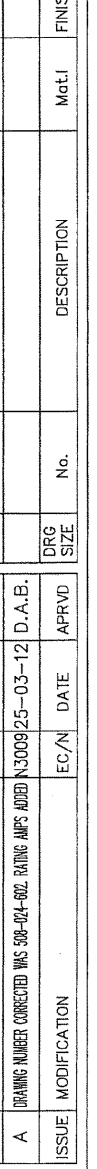
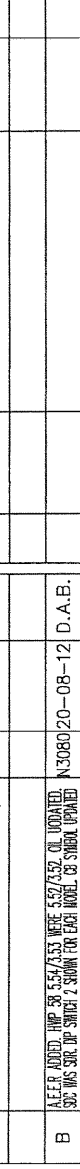
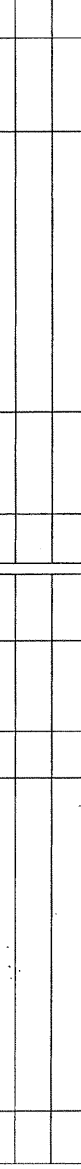
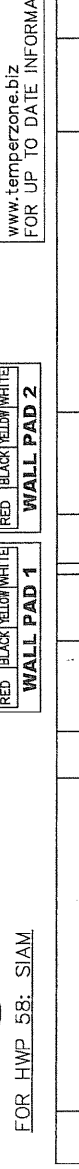
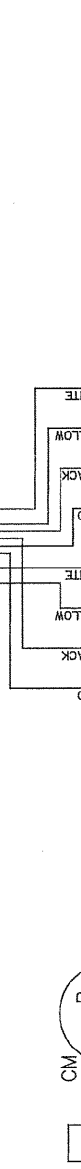
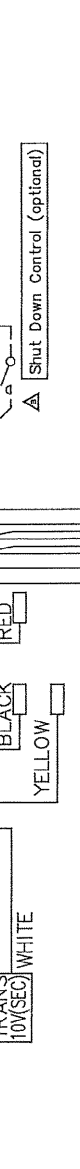
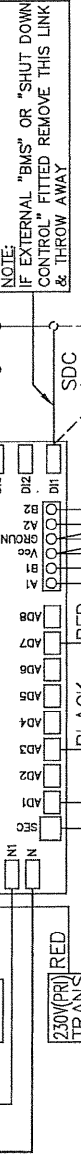

Programmed by	
PLOTTED	
20-08-12	
temperzone ltd	
2009	
ASSTY	
FINISH	
Mat'l	
DESCRIPTION	
No.	
DRG	
SIZE	
APRVD	
DATE	
EC/N	
MODIFICATION	
ISSUE	
Revision	
Drawing No.	
508-014-602	
Date	
27-03-11	
Drawn D.A.B	
Scale	
Revision	
B	

Title		HWP 35&47&58 CKSYD
WIRING SCHEMATIC		
Programmed by		
PLOTTED		
20-08-12		
temperzone ltd		
2009		
ASSTY		
FINISH		
Mat'l		
DESCRIPTION		
No.		
DRG		
SIZE		
APRVD		
DATE		
EC/N		
MODIFICATION		
ISSUE		
Revision		
Drawing No.		
508-014-602		
Date		
27-03-11		
Drawn D.A.B		
Scale		
Revision		
B		



HWP 35-58 CEKSYD

SPECIFICATION TABLE		HWP	HWP	HWP	HWP
CAPACITIES - AS/NZS 3823		MODEL	35CE	47CE	58CE
COOLING - NET		kW	3.37	4.41	5.54
HEATING - ELECTRIC HEAT		kW	2.00	2.00	3.00
ELECTRICAL INPUT					
COOLING -		kW/TRA	0.84/4.1	1.22/5.4	1.57/7.5
HEATING - ELECTRIC HEAT		kW/TRA	2.10/9.0	2.10/9.2	3.1/13.5
E.E.R. (COOLING)		kW/kW	3.58	3.61	3.53
A.E.E.R. (COOLING)		kW/kW	3.55	3.59	3.50
ELECTRICAL					
SUPPLY REQUIRED 1PH 200-252V ~ 50Hz INCLUDING VOLTAGE FLUCTUATION LIMITS					
COMPRESSOR RUN AMPS AT RATING		A	3.75	4.92	7.05
COMPRESSOR CAPACITOR SIZE		uFd	30	40	40
RATING AMPS		A	4.1	5.38	7.2
MAX RUNNING AMPS (TOTAL)		A	6.7	8.2	9.4
REFRIGERANT - R410A		grams	620	800	880
WEIGHT - NET		kg	6.3	6.5	7.4
COMPRESSOR TYPE: ROTARY					
OIL TYPE: PVE					

EC-BOARD SPEED SELECTION - DIP SWITCH 2 (DIP2)	
SWITCH 1	OFF OFF OFF OFF OFF OFF OFF OFF OFF OFF
SWITCH 2	OFF ON OFF ON OFF ON OFF ON OFF ON
SWITCH 3	OFF OFF ON ON OFF OFF ON ON OFF ON
SWITCH 4	OFF OFF OFF OFF OFF OFF OFF OFF OFF OFF
SWITCH 5	OFF OFF OFF OFF OFF OFF OFF OFF OFF OFF
Max (rpm)	1500 1400 1350 1300 1200 1100 1000 900 800 700
Min (rpm)	1200 1000 1050 1000 900 800 700 600 500 400
Model HWP	58

DIP1 SWITCH SETTING		STANDARD SETTING	
1	OFF	OFF	ON
2	OFF	OFF	ON
3	OFF	OFF	ON
4	OFF	OFF	ON

DIP2 SWITCH SETTING		STANDARD SETTING	
1	OFF	OFF	ON
2	OFF	OFF	ON
3	OFF	OFF	ON
4	OFF	OFF	ON
5	OFF	OFF	ON
6	OFF	OFF	ON
7	OFF	OFF	ON
8	OFF	OFF	ON

DIP3 SWITCH SETTING		STANDARD SETTING	
1	OFF	OFF	ON
2	OFF	OFF	ON
3	OFF	OFF	ON
4	OFF	OFF	ON
5	OFF	OFF	ON
6	OFF	OFF	ON
7	OFF	OFF	ON
8	OFF	OFF	ON

SAT 2 BOARD DEFINITIONS	
GUT1	1-WAY VALVE
GUT2	HEATER
GUT3	SWING/COMP2
GUT4	DRAIN PUMP
GUT5	POWER IN
GUT6	ZONE/MOTOR
ALRM	FAULT RELAY
RELAY1	ZONE CONTROL BOARD
COM	COMMON
D16	HP SWITCH
D15	FLOAT SWITCH
D14	HYDRONIC PUMP
D13	NO FUNCTION
D12	NO FUNCTION
D11	SD
ADB	DISCHARGE 2
AD7	DISCHARGE 1
AD6	RETURN AIR 4
AD5	RETURN AIR 3/INDOOR COIL 2
AD4	RETURN AIR 2/A1ST
AD3	RETURN AIR 1
AD2	LST 1
AD1	INDOOR COIL 1
SEC	TRANSFORMER SECONDARY
PR1	TRANSFORMER PRIMARY

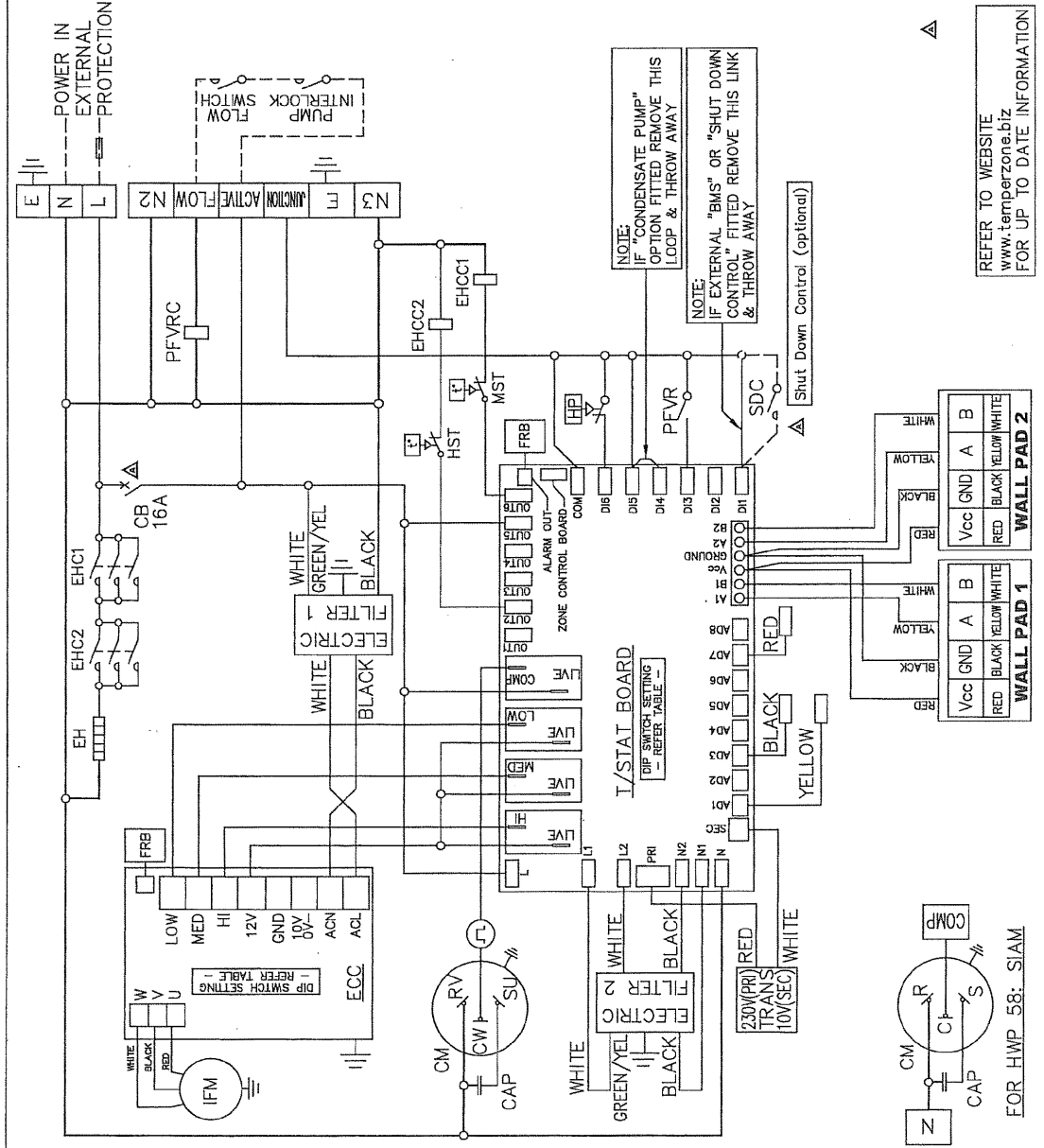

Title	
HWP 35&47&58 CEKSYD	
WIRING SCHEMATIC	
Drawn D.A.B	Date 25-03-12
Scale	508-024-602
Revision	A

Programmed by	
PLOTTED	
20-08-12	
©temperzone ltd	
2009	

ISSUE	MODIFICATION	EC/N	DATE	APRVD	DRG	SIZE	No.	DESCRIPTION	Mat.L	FINISH	ASSY
A	A.E.E.R. ADDED. HWP 35, 47 & 58 WERE 5.57/25.9. OIL UPDATED. SDC HAS SR. HP SWITCH 2. SHOWING FOR EACH MODEL. (28 SYMBOL UPDATED)	N3080	20-08-12	D.A.B.							



HWP 35-58 RKSYS

SAT 2 BOARD DEFINITIONS

OUT1	W/VALVE
OUT2	HEAT
OUT3	SWING/COMP2
OUT4	DRAN/PUMP
OUT5	POWER IN
OUT6	ZONE/MOTOR
ALARM OUT	FAULT RELAY
RELAY1	ZONE CONTROL BOARD
COM	COMMON
DIP	UP SWITCH
FLT	FLOAT SWITCH
HYD	HYDRONIC PUMP
NO	NO FUNCTION
SD	DISCHARGE 2
AD6	DISCHARGE 1
AD7	RETURN AIR 4
AD5	RETURN AIR 3/INDOOR COIL 2
AD4	RETURN AIR 2/SET
AD3	RETURN AIR 1
AD2	LST 1
AD1	INDOOR COIL 1
SEC	TRANSFORMER SECONDARY
PR	TRANSFORMER PRIMARY

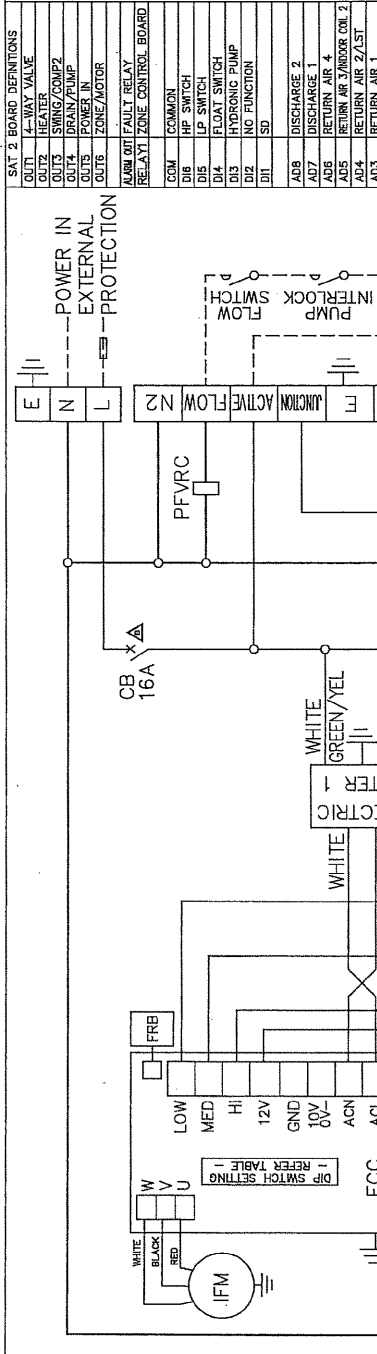

SPECIFICATION TABLE

CAPACITIES - AS/NZS 3623	HWP	HWP	HWP
COOLING - NET	MODEL	35R	47R
HEATING - REVERSE CYCLE	KW	3.37	4.41
ELECTRICAL INPUT	KW	3.10	4.38
COOLING -	KW/TRA	0.94/4.1	1.22/5.4
HEATING - REVERSE CYCLE	KW/TRA	0.66/3.7	1.13/4.88
E.E.R. (COOLING)	KW/KW	3.58	3.61
A.E.E.R. (COOLING)	KW/KW	3.55	3.59

ELECTRICAL

SUPPLY REQUIRED 1Ph. 200-252V ~ 50Hz INCLUDING VOLTAGE FLUCTUATION LIMITS	A	3.75	4.92	7.05
COMPRESSOR RUN AMPS AT RATING	uFd	30	40	40
COMPRESSOR CAPACITOR SIZE	A	4.1	5.38	7.2
RATING AMPS	A	6.7	6.2	9.4
MAX RUNNING AMPS (TOTAL)	grams	620	800	880
REFRIGERANT - R410A	kg	63	65	74
WEIGHT - NETT				
COMPRESSOR TYPE: ROTARY				
OIL TYPE: PVE				

EC-BOARD SPEED SELECTION - DIP SWITCH 2 (DIP2)

SWITCH 1	OFF	OFF	OFF	OFF	OFF	OFF	OFF
SWITCH 2	OFF	ON	OFF	OFF	OFF	OFF	OFF
SWITCH 3	OFF	OFF	ON	OFF	OFF	OFF	OFF
SWITCH 4	OFF	OFF	OFF	ON	OFF	OFF	OFF
SWITCH 5	OFF	OFF	OFF	OFF	ON	OFF	OFF
Max (rpm)	1500	1400	1350	1300	1200	1100	1000
Min (rpm)	1200	1000	1050	1000	900	800	700
Model HWP							35/47

DIP1 SWITCH SETTING

1	OFF	ON
2	OFF	ON
3	OFF	ON
4	OFF	ON

DIP SWITCH SETTING

1	OFF	ON
2	OFF	ON
3	OFF	ON
4	OFF	ON
5	OFF	ON
6	OFF	ON
7	OFF	ON
8	OFF	ON

CLIENT WIRING

CAP	CAPACITOR
CB	CIRCUIT BREAKER
CM	COMPRESSOR MOTOR
ECC	EC MOTOR CONTROLLER
FRB	FAULT RELAY BOARD
HP	HIGH PRESSURE CONTROL
IFM	INDOOR FAN MOTOR
PFVRC	PUMP FLOW VERIFICATION RELAY COIL
RCV	REVERSING VALVE
SDC	SHUT DOWN CONTROL
TRF	TOTAL RUNNING AMPS

EC-BOARD SPEED SELECTION - DIP SWITCH 2 (DIP2)

1	OFF	ON
2	OFF	ON
3	OFF	ON
4	OFF	ON
5	OFF	ON
6	OFF	ON
7	OFF	ON
8	OFF	ON

DIP SWITCH SETTING

1	OFF	ON
2	OFF	ON
3	OFF	ON
4	OFF	ON

DIP SWITCH SETTING

1	OFF	ON
2	OFF	ON
3	OFF	ON
4	OFF	ON
5	OFF	ON
6	OFF	ON
7	OFF	ON
8	OFF	ON

WIRING SCHEMATIC

1	0-10V CONTROL
2	REVERSE ACTION
3	NO POWER LIMIT DO NOT USE
4	DO NOT USE

DIP SWITCH SETTING

1	OFF	ON
2	OFF	ON
3	OFF	ON
4	OFF	ON
5	OFF	ON
6	OFF	ON
7	OFF	ON
8	OFF	ON

WALL PAD 1

Vcc	RED
GND	BLACK
A	YELLOW
B	WHITE

WALL PAD 2

Vcc	RED
GND	BLACK
A	YELLOW
B	WHITE

temperzone

HWP 35&47&58 RKSYS
WIRING SCHEMATIC

Programmed by

PLOTTED
20-08-12
©temperzone ltd
2009

Scale
Date 27-03-11
Drawing No. 507-014-602
Revision B

ISSUE	MODIFICATION	EC/N	DATE	APRVD	DRG	SIZE	No.	DESCRIPTION	Mat'l	FINISH	ASSY	No.
B	A.E.E.R. ADDED. HWP 58 5.57/25.3 WERE 5.57/25.2 ON UPDATED. SDC WAS SUP. UP SWITCH 2. SEPAR. FOR EACH MODEL. CE SWIRK. UPDATED		N308020-08-12	D.A.B.								
A	RATING AMPS ADDED		N3008925-03-12	D.A.B.								

HWP 35-58 CKSYN

SPECIFICATION TABLE		HWP	HWP	HWP
CAPACITIES - AS/NZS 3823		MODEL	35C	56C
COOLING - NET		KW	3.37	4.41
ELECTRICAL INPUT				5.54
COOLING -				
E.E.R. (COOLING)		KW/TR	0.84/4.1	1.22/5.4
A.E.E.R. (COOLING)		KW/kW	3.58	3.61
ELECTRICAL		KW/kW	3.55	3.59
SUPPLY REQUIRED IPR 200-252V ~ 50Hz INCLUDING VOLTAGE FLUCTUATION LIMITS				
COMPRESSOR RUN AMPS AT RATING		A	3.75	4.92
COMPRESSOR CAPACITOR SIZE		µF	30	40
RATING AMPS		A	4.1	5.38
MAX RUNNING AMPS (TOTAL)		A	6.7	8.2
REFRIGERANT - R410A		grams	620	800
WEIGHT - NETT		kg	63	65
COMPRESSOR TYPE: ROTARY				74
OIL TYPE: PVE				

PROTECTION BOARD DEFINITIONS	
PUMP	FAN SPEED CONTROL
COMP	COMPRESSOR MOTOR
LIVE	COMPRESSOR MOTOR
PUMP IN	COMPRESSOR MOTOR
PUMP OUT	COMPRESSOR MOTOR
COMP ON	COMPRESSOR MOTOR
HEAT IN	HEAT PUMP
HEAT OUT	HEAT PUMP
DRY	DRY CONTACT
HP	HEAT PUMP
ERR	ERROR
LST	LOW SUCTON TEMP. SENSOR
DT	DISCHARGE TEMP. SENSOR
ID	INDOOR COIL TEMP. SENSOR
SEC	TRANSFORMER SECONDARY
PRI	TRANSFORMER PRIMARY

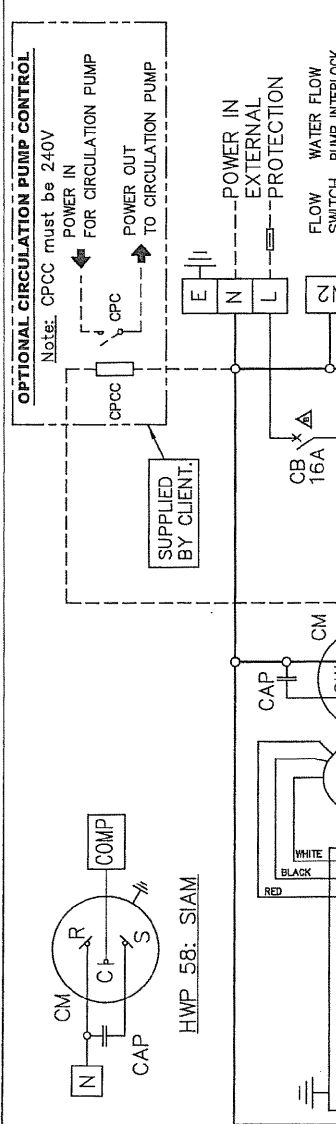

EC-BOARD SPEED SELECTION - DIP SWITCH 2 (DIP2)	
SWITCH 1	OFF OFF OFF OFF OFF OFF OFF OFF OFF OFF
SWITCH 2	OFF ON OFF ON OFF ON OFF ON OFF ON
SWITCH 3	OFF ON OFF ON OFF ON OFF ON OFF ON
SWITCH 4	OFF ON OFF ON OFF ON OFF ON OFF ON
SWITCH 5	OFF OFF OFF OFF OFF OFF OFF OFF OFF OFF
Max. (rpm)	1500 1400 1350 1300 1200 1100 1000 900 800 700
Min. (rpm)	1200 1000 1050 1000 900 800 700 600 500 400
Model HWP	58

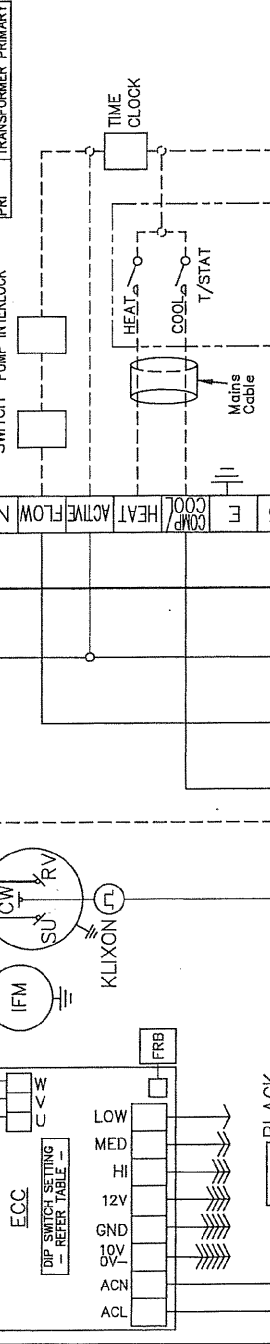

DIP SWITCH SETTINGS	
1	OFF ON
2	OFF ON
3	OFF ON
4	OFF ON

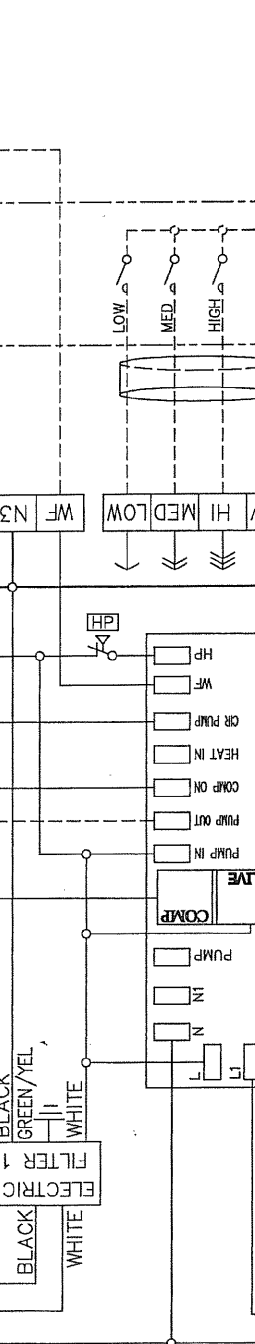

DIP SWITCH SETTINGS	
1	OFF ON
2	OFF ON
3	OFF ON
4	OFF ON

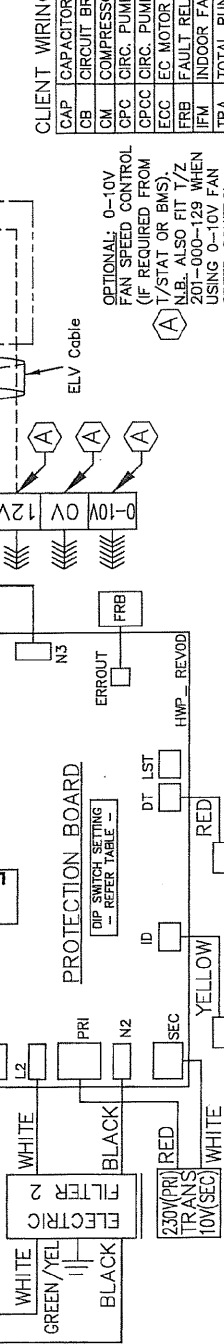

PROTECTION BOARD SETTINGS	
1	OFF ON
2	OFF ON
3	OFF ON
4	OFF ON

Title	
HWP 35&47&58 CKSYN	WIRING SCHEMATIC
Drawn D.A.B	Date 10-09-10
Scale	As Shown
Revision	B
Drawing No.	508-034-602

ISSUE	MODIFICATION	EC/N	DATE	APRVD	DRG SIZE	No.	DESCRIPTION	Mat'l	FINISH	ASSY No.
B	ALTER ADDED: HWP 35-58/53 WERE 35/52/52. (LIVE) DIP SWITCH 2 SHOWN FOR EACH MODEL OR SYMBOL UPDATED		N3080 20-08-12	D.A.B.						
A	DRAWING NUMBER CORRECTED WAS 508-04-602. RATING AMPS ADDED		N3009 25-03-12	D.A.B.						

Programmed by	
PLOTTED 20-08-12	
©temperzone ltd 2009	



HWP 35&47&58 CKSYN
WIRING SCHEMATIC

HWP 35-58 RKSYN

SPECIFICATION TABLE		HWP	HWP	HWP
CAPACITIES - AS/NZS 3823		36R	47R	58R
COOLING - NET		kW	3.37	4.41
HEATING - REVERSE CYCLE		kW	3.10	4.38
ELECTRICAL INPUT				
COOLING -		kW/TRA	0.94/4.1	1.22/5.4
HEATING - REVERSE CYCLE		kW/TRA	0.86/3.7	1.13/4.86
E.E.R. (COOLING)		kW/kW	3.58	3.61
A.E.E.R. (COOLING) Δ		kW/kW	3.55	3.59
ELECTRICAL				
SUPPLY REQUIRED 1Ph 200-252V ~ 50Hz INCLUDING VOLTAGE FLUCTUATION LIMITS				
COMPRESSOR RUN AMPS AT RATING		A	3.75	4.92
COMPRESSOR CAPACITOR SIZE		µF	30	40
RATING AMPS		A	5.38	7.2
MAX RUNNING AMPS (TOTAL)		A	6.7	8.2
REFRIGERANT - R410A		grams	620	860
WEIGHT - NETT		kg	63	65
COMPRESSOR TYPE: ROTARY				74
OIL TYPE: PVE Δ				58

EC-BOARD SPEED SELECTION - DIP SWITCH 2 (DIP2)	
SWITCH 1	OFF OFF OFF OFF OFF OFF OFF OFF OFF OFF
SWITCH 2	OFF ON OFF ON OFF ON OFF ON OFF ON
SWITCH 3	OFF OFF ON ON OFF OFF ON ON OFF OFF
SWITCH 4	OFF OFF OFF OFF OFF OFF OFF OFF OFF OFF
SWITCH 5	OFF OFF OFF OFF OFF OFF OFF OFF OFF OFF
Max (rpm)	1500 1400 1350 1300 1200 1100 1000 900 800 700
Min (rpm)	1200 1000 1050 1000 900 800 700 600 500 400
Model HWP	58 35/47

STANDARD SETTING	
1	OFF ON
2	ON OFF
3	OFF ON
4	OFF ON

STANDARD SETTING	
1	OFF ON
2	OFF ON
3	OFF ON
4	OFF ON

STANDARD SETTING	
1	OFF ON
2	OFF ON
3	OFF ON
4	OFF ON

STANDARD SETTING	
1	OFF ON
2	OFF ON
3	OFF ON
4	OFF ON

STANDARD SETTING	
1	OFF ON
2	OFF ON
3	OFF ON
4	OFF ON

STANDARD SETTING	
1	OFF ON
2	OFF ON
3	OFF ON
4	OFF ON

STANDARD SETTING	
1	OFF ON
2	OFF ON
3	OFF ON
4	OFF ON

STANDARD SETTING	
1	OFF ON
2	OFF ON
3	OFF ON
4	OFF ON

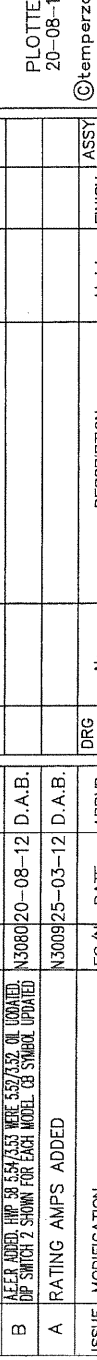
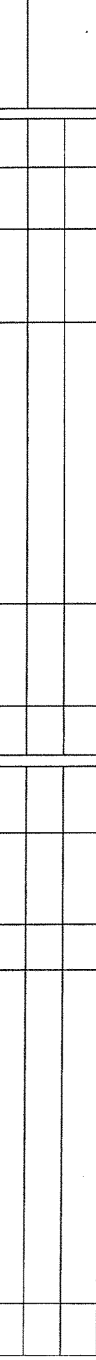
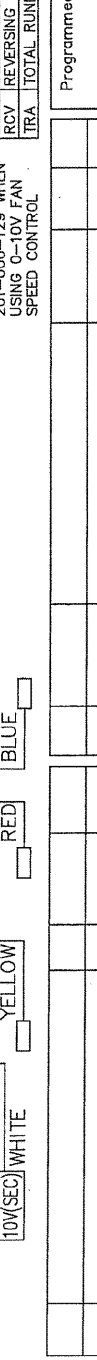
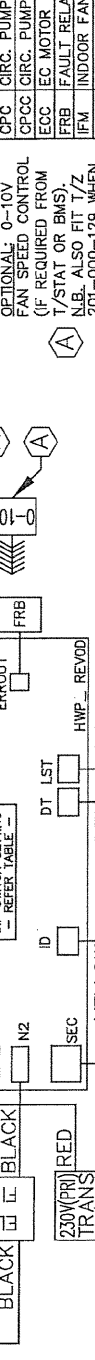
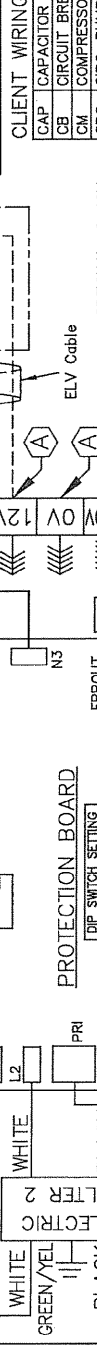
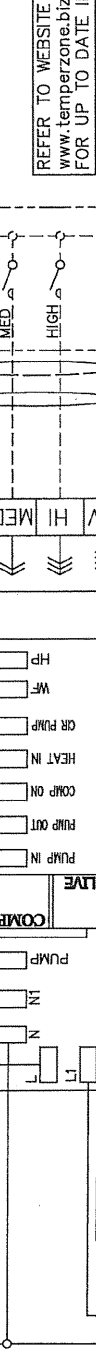
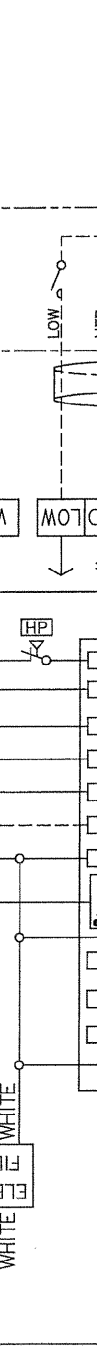
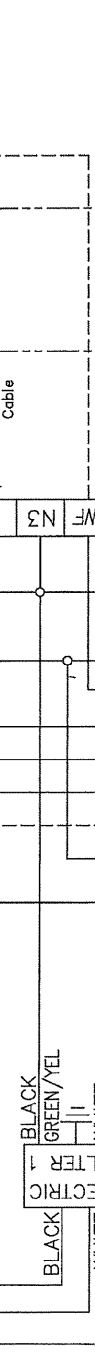
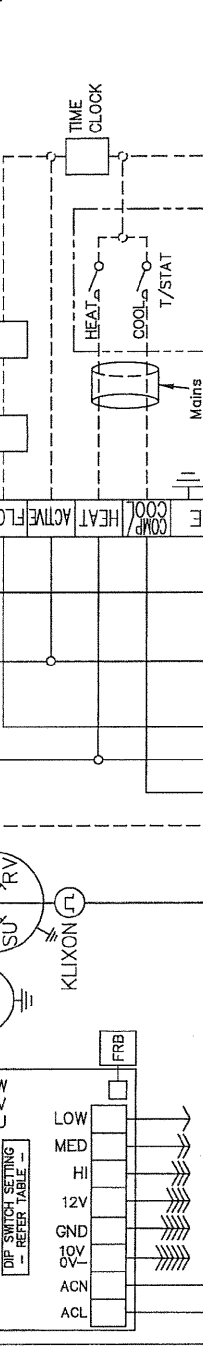
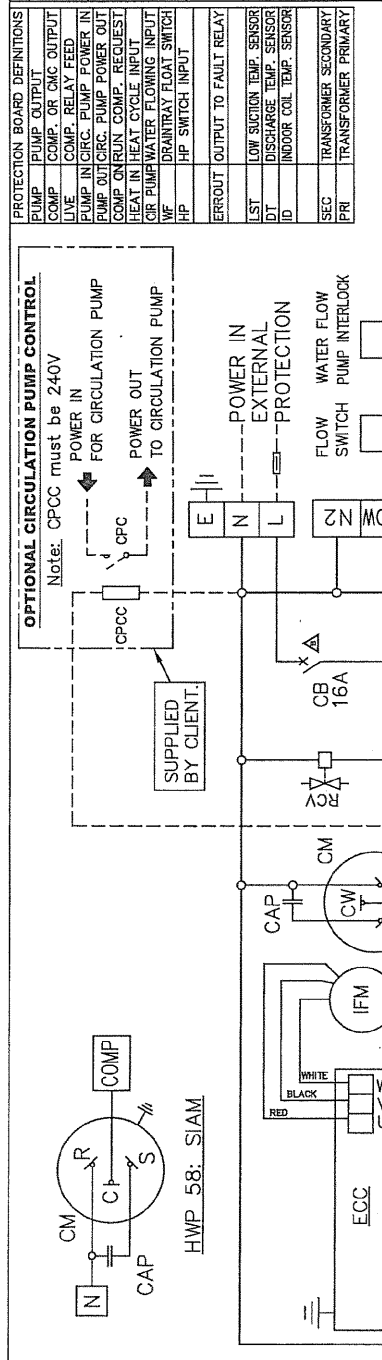

Programmed by
 PLOTTED
 20-08-12
 ©temperzone ltd
 2009

Scale
 Date 10-09-10
 Drawing No.
 Revision

HWP 35&47&58 RKSYN
 WIRING SCHEMATIC

temperzone

507-034-602
 B

ISSUE	MODIFICATION	EC/N	DATE	APRVD	DRG SIZE	No.	DESCRIPTION	Mat'l	FINISH	ASSY No.
B	A.E.E.R. ADDED, HWP 38 5.54/3.53 WERE 5.52/4.52 ON UPDATED. DIP SWITCH 2 SHOWN FOR EACH MODEL. CB SYMBOL UPDATED.		N3080 20-08-12	D.A.B.						
A	RATING AMPS ADDED		N3009 25-03-12	D.A.B.						