

1. Features

1.1 System Features

New DC Inverter UTOPIA Series for Single Power Source

HITACHI proudly introduces the New "DC Inverter UTOPIA" HVRNM2 series, the highly-efficient and reliable air conditioning system, for the Oceanian markets. Recently, increased numbers of buildings and shops are requiring "Intelligent" facilities - communication networks, office automation, including a comfortable environment. In addition to that, energy saving operation is needed.

Particularly, comfortable space is required all the day through the year in shops and office buildings.

This split air conditioner, "DC Inverter UTOPIA" can meet these requirements. The proven combination of the scroll compressor and the inverter provides the best air conditioning for shops and small office buildings.

New Line-up of Indoor and Outdoor Units

Type		Model Name
Indoor Unit	In-the-Ceiling (Duct)	RPI-3.0FSN2SQ
		RPI-4.0FSN2SQ
		RPI-5.0FSN2SQ
		RPI-6.0FSN2SQ
		RPI-7.0FSN2SQ
	4-Way Cassette	RCI-1.0FSN3
		RCI-1.5FSN3
		RCI-2.0FSN3
		RCI-2.5FSN3
		RCI-3.0FSN3
		RCI-4.0FSN3
		RCI-5.0FSN3
	RCI-6.0FSN3	
Air Panel (Optional)	without Motion Sensor	P-AP160NA1
	with Motion Sensor	P-AP160NAE
Outdoor Unit		RAS-3HVRNM2
		RAS-4HVRNM2
		RAS-5HVRNM2
		RAS-6HVRNM2
		RAS-7HVRNM2

Standard Combination of Outdoor Unit and Indoor Unit

Outdoor Unit	Indoor Unit	Single Combination	Twin Combination	Triple Combination	Quad Combination
RAS-3HVRNM2	In-the-Ceiling Type (RPI-*FSN2SQ)	RPI-3.0FSN2SQ	-	-	-
	4-Way Cassette Type (RCI-*FSN3)	RCI-3.0FSN3	RCI-1.5FSN3 x 2	-	-
	In-the-Ceiling Type (RPI-*FSN2)	-	RPI-1.5FSN2 x 2	-	-
	2-Way Cassette Type (RCD-*FSN2)	-	RCD-1.5FSN2 x 2	-	-
	Ceiling Type (RPC-*FSN2)	-	-	-	-
	Wall Type (RPK-*FSNSM2)	-	RPK-1.5FSNSM2 x 2	-	-
RAS-4HVRNM2	In-the-Ceiling Type (RPI-*FSN2SQ)	RPI-4.0FSN2SQ	-	-	-
	4-Way Cassette Type (RCI-*FSN3)	RCI-4.0FSN3	RCI-2.0FSN3 x 2	RCI-1.5FSN3 x 3	RCI-1.0FSN3 x 4
	In-the-Ceiling Type (RPI-*FSN2)	-	RPI-2.0FSN2 x 2	RPI-1.5FSN2 x 3	RPI-1.0FSN2 x 4
	2-Way Cassette Type (RCD-*FSN2)	-	RCD-2.0FSN2 x 2	RCD-1.5FSN2 x 3	RCD-1.0FSN2 x 4
	Ceiling Type (RPC-*FSN2)	-	RPC-2.0FSN2 x 2	-	-
	Wall Type (RPK-*FSNSM2)	-	RPK-2.0FSNSM2 x 2	RPK-1.5FSNSM2 x 3	RPK-1.0FSNSM2 x 4
RAS-5HVRNM2	In-the-Ceiling Type (RPI-*FSN2SQ)	RPI-5.0FSN2SQ	-	-	-
	4-Way Cassette Type (RCI-*FSN3)	RCI-5.0FSN3	RCI-2.5FSN3 x 2	RCI-1.5FSN3 x 3	RCI-1.0FSN3 x 4
	In-the-Ceiling Type (RPI-*FSN2)	-	RPI-2.5FSN2 x 2	RPI-1.5FSN2 x 3	RPI-1.0FSN2 x 4
	2-Way Cassette Type (RCD-*FSN2)	-	RCD-2.5FSN2 x 2	RCD-1.5FSN2 x 3	RCD-1.0FSN2 x 4
	Ceiling Type (RPC-*FSN2)	-	RPC-2.5FSN2 x 2	-	-
	Wall Type (RPK-*FSNSM2)	-	RPK-2.5FSNSM2 x 2	RPK-1.5FSNSM2 x 3	RPK-1.0FSNSM2 x 4
RAS-6HVRNM2	In-the-Ceiling Type (RPI-*FSN2SQ)	RPI-6.0FSN2SQ	-	-	-
	4-Way Cassette Type (RCI-*FSN3)	-	RCI-3.0FSN3 x 2	RCI-2.0FSN3 x 3	RCI-1.5FSN3 x 4
	In-the-Ceiling Type (RPI-*FSN2)	-	RPI-3.0FSN2 x 2	RPI-2.0FSN2 x 3	RPI-1.5FSN2 x 4
	2-Way Cassette Type (RCD-*FSN2)	-	RCD-3.0FSN2 x 2	RCD-2.0FSN2 x 3	RCD-1.5FSN2 x 4
	Ceiling Type (RPC-*FSN2)	-	RPC-3.0FSN2 x 2	RPC-2.0FSN2 x 3	-
	Wall Type (RPK-*FSNSM2)	-	RPK-3.0FSNSM2 x 2	RPK-2.0FSNSM2 x 3	RPK-1.5FSNSM2 x 4
RAS-7HVRNM2	In-the-Ceiling Type (RPI-*FSN2SQ)	RPI-7.0FSN2SQ	-	-	-
	4-Way Cassette Type (RCI-*FSN3)	-	-	-	-
	In-the-Ceiling Type (RPI-*FSN2)	-	-	-	-
	2-Way Cassette Type (RCD-*FSN2)	-	-	-	-
	Ceiling Type (RPC-*FSN2)	-	-	-	-
	Wall Type (RPK-*FSNSM2)	-	-	-	-

- The single connection is subject to MEPS. Other connections are NOT acceptable.
- Refer to the Technical Catalog "TCI-08001" as to the information of indoor units RPI, RCD, RPC and RPK models.

Enhanced Combination of Outdoor Unit and Indoor Unit

- (1) The combination is available with the range of the following conditions. Less than the recommended number of indoor unit should be connected in order to prevent the cold draft during the heating operation with the system that all the indoor units are operated simultaneously.

Outdoor Unit Capacity		3HP	4HP	5HP	6HP	7HP
Recommended Number of Connectable Indoor Unit		≤ 2 Units	≤ 4 Units			1 Unit
Maximum Number of Connectable Indoor Unit		3 Units	5 Units	6 Units		1 Unit
Minimum Indoor Unit Capacity		1HP				7HP
Range of Combination Capacity of Indoor Unit (The case of exceeding the recommended number of connectable units)		50-120% (50-100%)				100%
Minimum Indoor Unit Capacity	In-the-Ceiling Type (RPI-*FSN2SQ)	Only 3HP	Only 4HP	Only 5HP	Only 6HP	Only 7HP
	4-Way Cassette Type (RCI-*FSN3)	1HP				-
	In-the-Ceiling Type (RPI-*FSN2)	0.8HP				-
	2-Way Cassette Type (RCD-*FSN2)	1HP				-
	Ceiling Type (RPC-*FSN2)	2HP				-
	Wall Type (RPK-*FSNSM2)	1HP				-

- (2) (Total Indoor Unit Capacity / Total Outdoor Unit Capacity) should be within the value as shown in the table above.
- (3) 1.0HP of the indoor unit is designed as the higher air flow volume than over 1.5HP of the indoor unit. Do not install a space where the cold draft may be felt (at heating).
- (4) If 4-Way Cassette Type or Ceiling Type indoor unit is connected to the outdoor unit, less than recommended number of the indoor unit should be connected. In addition, the range of the combination capacity of the indoor unit including these types should be within 100%. If the system is used in the cold area (outside temperature becomes -10°C) or under the high heating load conditions, the total indoor unit capacity should be less than 100% against the outdoor unit.
- (5) The minimum indoor unit capacity should be within the following table against the maximum indoor unit capacity in the same refrigerant cycle when multiple indoor units are connected.

Max. Indoor Unit Capacity	0.8HP	1.0HP	1.5HP	2.0HP	2.5HP	3.0HP	4.0HP	5.0HP
Min. Indoor Unit Capacity	≥ 0.8HP			≥ 1.0HP	≥ 1.5HP			≥ 2.0HP

2. General Data

2.1 Indoor Units

Indoor Unit Type		In-the-Ceiling (Duct) Type				
Model		RPI-3.0FSN2SQ	RPI-4.0FSN2SQ	RPI-5.0FSN2SQ	RPI-6.0FSN2SQ	RPI-7.0FSN2SQ
Indoor Unit Power Supply		AC 1 ϕ , 220-240V/50Hz, 220V/60Hz				AC 1 ϕ , 240V/50Hz
Sound Pressure Level (Overall A Scale) (Hi/Me/Lo)						
High Pressure Setting	dB	46/44/40	48/45/41	49/46/43	53/49/45	51/47/42
Standard Pressure Setting	dB	45/43/39	47/44/40	48/45/42	52/48/44	-
Outer Dimensions						
Height	mm (in.)	350 (13-3/4)	350 (13-3/4)	350 (13-3/4)	350 (13-3/4)	440 (17-5/16)
Width	mm (in.)	1,076 (42-3/8)	1,076 (42-3/8)	1,300 (51-3/16)	1,300 (51-3/16)	1,430 (56-5/16)
Depth	mm (in.)	800 (31-1/2)	800 (31-1/2)	800 (31-1/2)	800 (31-1/2)	550 (21-5/8)
Net Weight	kg (lbs.)	52 (115)	57 (126)	61 (135)	63 (139)	75 (165)
Refrigerant		R410A				
Indoor Fan						
Air Flow Rate (Hi/Me/Lo)						
High Pressure Setting	m ³ /min. (l/s)	29/26/20 (483/433/333)	36/33/25 (600/550/417)	47/43/34 (783/717/567)	56/50/40 (933/833/667)	65/57/46 (1,083/950/767)
Standard Pressure Setting	m ³ /min. (l/s)	29/26/20 (483/433/333)	36/29/25 (600/483/417)	47/39/36 (783/650/600)	56/48/42 (933/800/700)	-
External Pressure *1)	Pa	120 (70)	120 (70)	120 (70)	120 (70)	140
Motor Output	W	250	300	420	550	650
Connections		Flare-Nut Connection (with Flare Nuts)				
Refrigerant Piping						
Liquid Line	mm (in.)	ϕ 9.52 (3/8)	ϕ 9.52 (3/8)	ϕ 9.52 (3/8)	ϕ 9.52 (3/8)	ϕ 9.52 (3/8)
Gas Line	mm (in.)	ϕ 15.88 (5/8)	ϕ 15.88 (5/8)	ϕ 15.88 (5/8)	ϕ 15.88 (5/8)	ϕ 15.88 (5/8)
Condensate Drain		VP25	VP25	VP25	VP25	VP25
Approximate Packing Measurement	m ³	0.49	0.49	0.57	0.57	0.54

NOTES:

- The above cooling and heating capacities show the maximum capacities when the outdoor and indoor temperature are below condition.

Cooling Operation Conditions

Indoor Air Inlet Temperature: 27°C DB (80°F DB)
19.0°C WB (66.2°F WB)
Outdoor Air Inlet Temperature: 35°C DB (95°F DB)

Heating Operation Conditions

Indoor Air Inlet Temperature: 20°C DB (68°F DB)
Outdoor Air Inlet Temperature: 7°C DB (45°F DB)
6°C WB (43°F WB)

Piping Length: 7.5 Meters Piping Lift: 0 Meter

- The sound pressure level is based on following conditions.
1.5 Meters Beneath the Unit.

With Discharge Duct (2.0m) and Return Duct (1.0m).

Voltage of the power source for the indoor fan motor is 220V.

In case of the power source of 240V, the sound pressure level increases by about 1 or 2 dB.

The above data was measured in an anechoic chamber so that reflected sound should be taken into consideration in the field.

- The data for external pressure *1) indicates "High Pressure Setting (Standard Pressure Setting)" values when a filter is not used.
The sound pressure level is based on the Standard Pressure Setting.

2.2 Outdoor Units

Model		RAS-3HVRNM2	RAS-4HVRNM2	RAS-5HVRNM2	RAS-6HVRNM2	RAS-7HVRNM2
Power Supply		AC 1 ϕ , 220-240V/50Hz, 220V/60Hz				
Nominal Cooling Capacity	kW	7.1	10.0	12.5	14.0	16.0
Nominal Heating Capacity	kW	8.0	11.2	14.0	16.0	18.0
Cabinet		Synthetic Resin Paint Baked on Galvanized Steel Plate				
Sound Pressure Level						
Cool (Night Shift)/Heat	dB (A)	45(41)/47	47(43)/49	48(44)/50	49(46)/51	49(46)/53
Outer Dimensions						
Height	mm (in.)	800 (31-1/2)	1,380 (54-5/16)	1,380 (54-5/16)	1,380 (54-5/16)	1,380 (54-5/16)
Width	mm (in.)	950 (37-3/8)	950 (37-3/8)	950 (37-3/8)	950 (37-3/8)	950 (37-3/8)
Depth	mm (in.)	370 (14-9/16)	370 (14-9/16)	370 (14-9/16)	370 (14-9/16)	370 (14-9/16)
Net Weight	kg (lbs.)	66 (146)	103 (227)	103 (227)	103 (227)	104 (229)
Refrigerant		R410A				
Flow Control		Micro-Computer Control Expansion Valve				
Compressor		Hermetic (Scroll)				
Model		2YC45KXD	E402HHD	E402HHD	E402HHD	E402HHD
Quantity		1	1	1	1	1
Motor Output (Pole)	kW	1.20 (6)	1.60 (6)	2.50 (4)	2.50 (4)	2.50 (4)
Heat Exchanger		Multi-Pass Cross-Finned Tube				
Condenser Fan		Propeller Fan				
Quantity		1	2	2	2	2
Air Flow Rate	m ³ /min. (l/s)	45 (750)	80 (1,333)	90 (1,500)	100 (1,667)	100 (1,667)
Motor Output (Pole)	kW	0.10 (8)	0.10 (8) + 0.10 (8)	0.10 (8) + 0.10 (8)	0.10 (8) + 0.10 (8)	0.10 (8) + 0.10 (8)
Refrigerant Piping		Flare-Nut Connection (with Flare Nuts)				
Liquid Line	mm (in.)	ϕ 9.52 (3/8)	ϕ 9.52 (3/8)	ϕ 9.52 (3/8)	ϕ 9.52 (3/8)	ϕ 9.52 (3/8)
Gas Line	mm (in.)	ϕ 15.88 (5/8)	ϕ 15.88 (5/8)	ϕ 15.88 (5/8)	ϕ 15.88 (5/8)	ϕ 15.88 (5/8)
Refrigerant Charge	kg	2.3	4.1	4.2	4.2	5.0
Approximate Packing Measurement	m ³	0.43	0.70	0.70	0.70	0.70

NOTES:

- The above cooling and heating capacities show the maximum capacities when the outdoor and indoor temperature are below condition.

Cooling Operation Conditions

Indoor Air Inlet Temperature: 27°C DB (80°F DB)
19.0°C WB (66.2°F WB)
Outdoor Air Inlet Temperature: 35°C DB (95°F DB)

Heating Operation Conditions

Indoor Air Inlet Temperature: 20°C DB (68°F DB)
Outdoor Air Inlet Temperature: 7°C DB (45°F DB)
6°C WB (43°F WB)

Piping Length: 7.5 Meters Piping Lift: 0 Meter

- The sound pressure is based on the following conditions.

1 Meter from the unit service cover surface, and 1.5 Meters from floor level.

The above data was measured in an anechoic chamber so that reflected sound should be taken into consideration in the field.

4. Selection Data

4.1 Operation Space

< In-the-Ceiling (Duct) Type >

Models: RPI-3.0FSN2SQ, RPI-4.0FSN2SQ, RPI-5.0FSN2SQ and RPI-6.0FSN2SQ

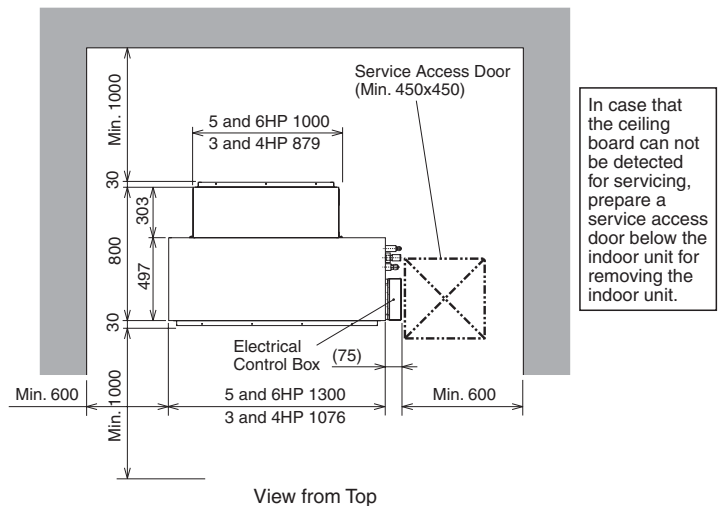

Model: RPI-7.0FSN2SQ

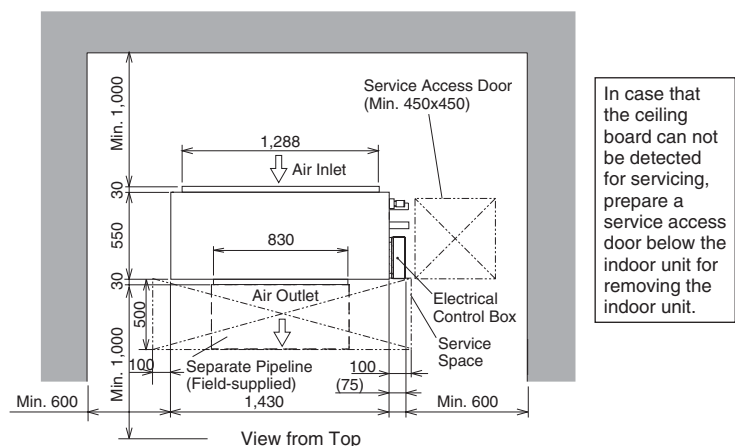

< 4-Way Cassette Type >

Models: RCI-1.0FSN3, RCI-1.5FSN3, RCI-2.0FSN3, RCI-2.5FSN3, RCI-3.0FSN3, RCI-4.0FSN3, RCI-5.0FSN3 and RCI-6.0FSN3

Unit: mm

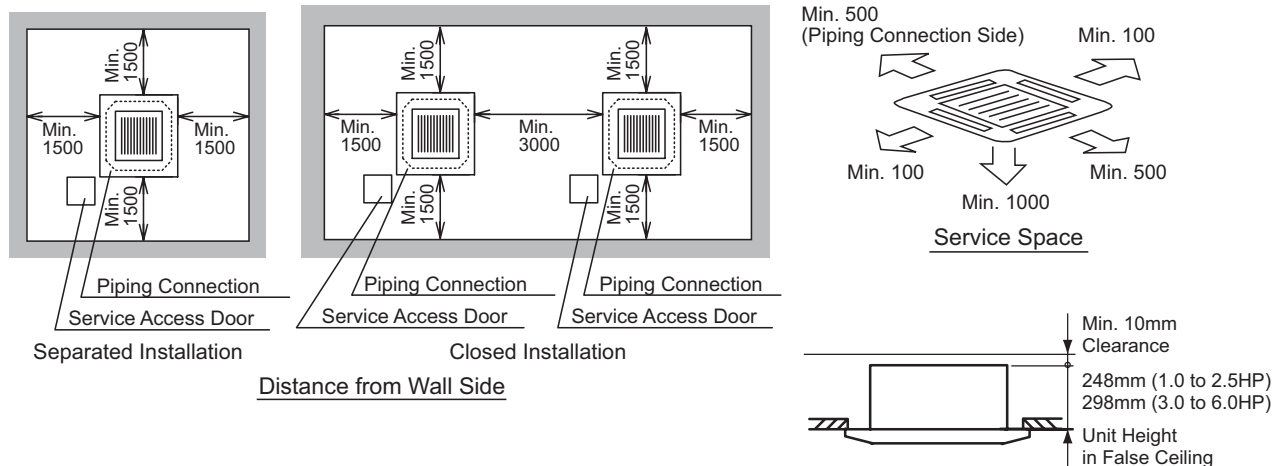

SELECTION DATA

< Outdoor Unit >

Install the outdoor unit with a sufficient space around the outdoor unit for operation and maintenance as shown below.

(1) Obstacles on Inlet Side

(a) Upper Side is Open.

(mm)

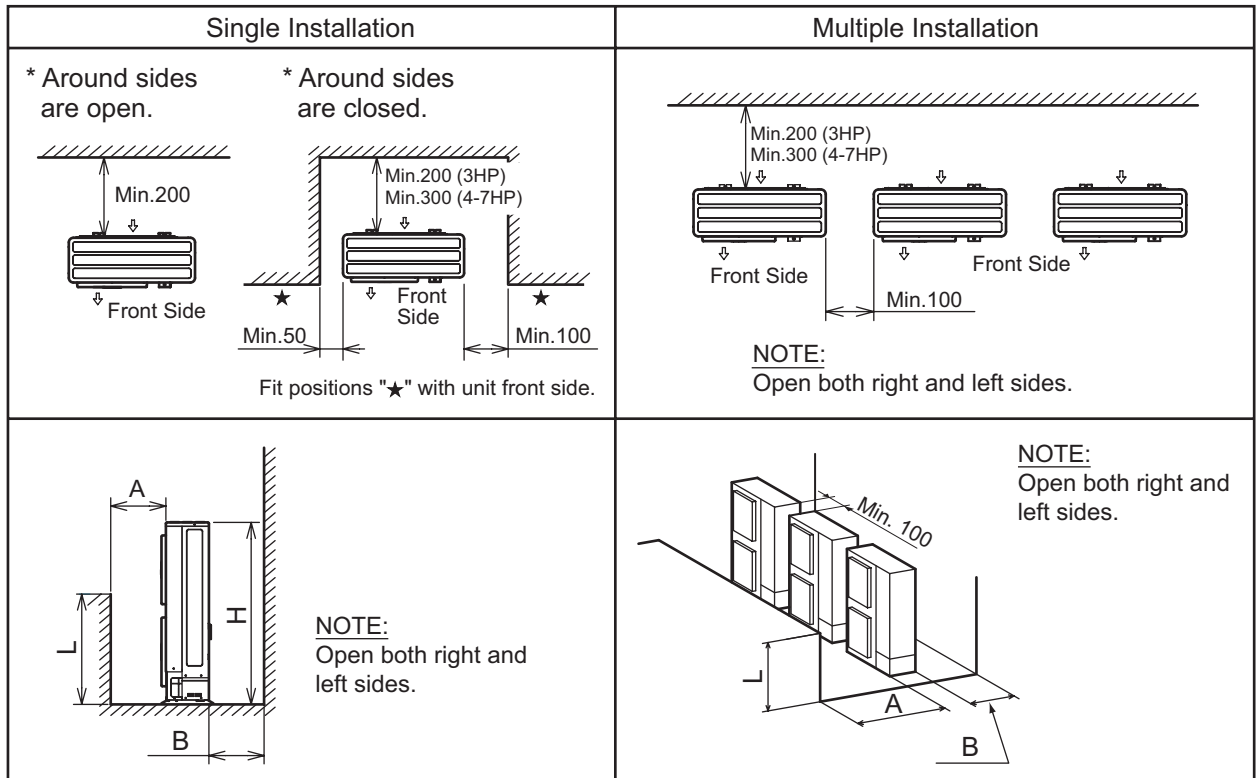

(b) Obstacles in Above

(mm)

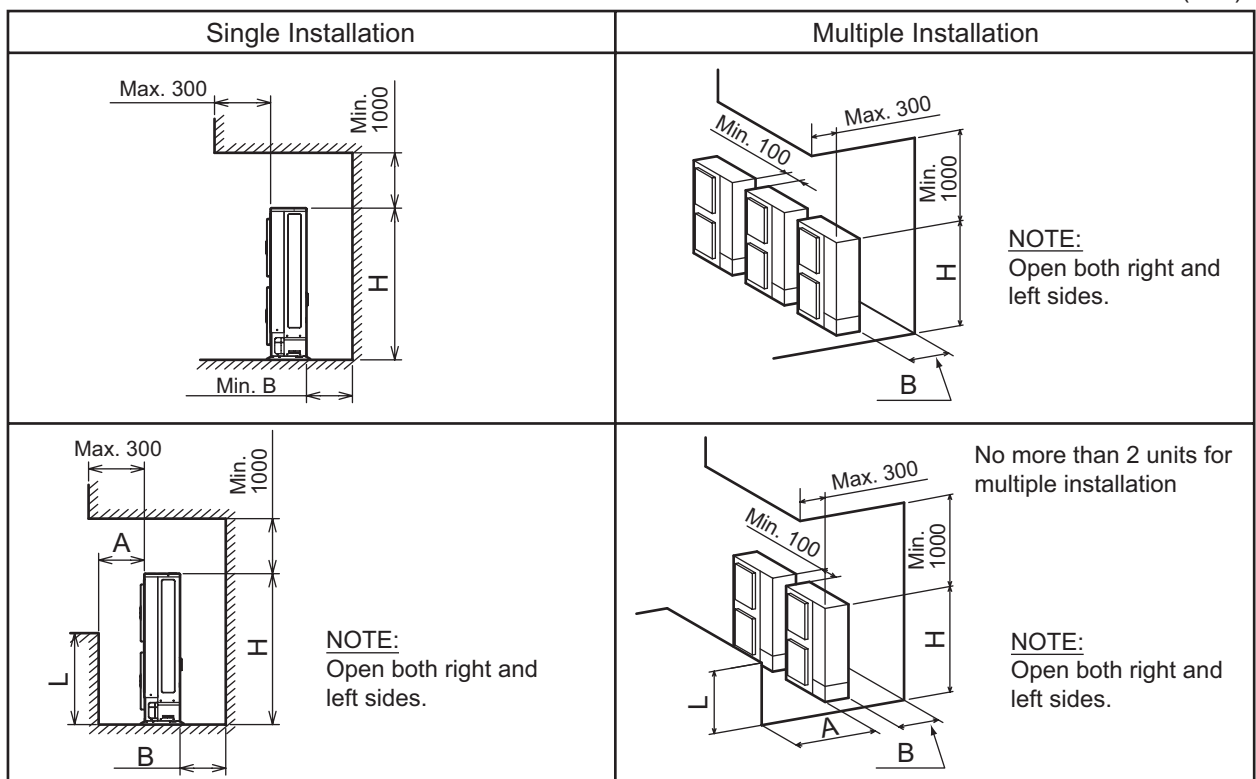

(2) Obstacles on Discharge Side

(a) Upper Side is Open.

(mm)

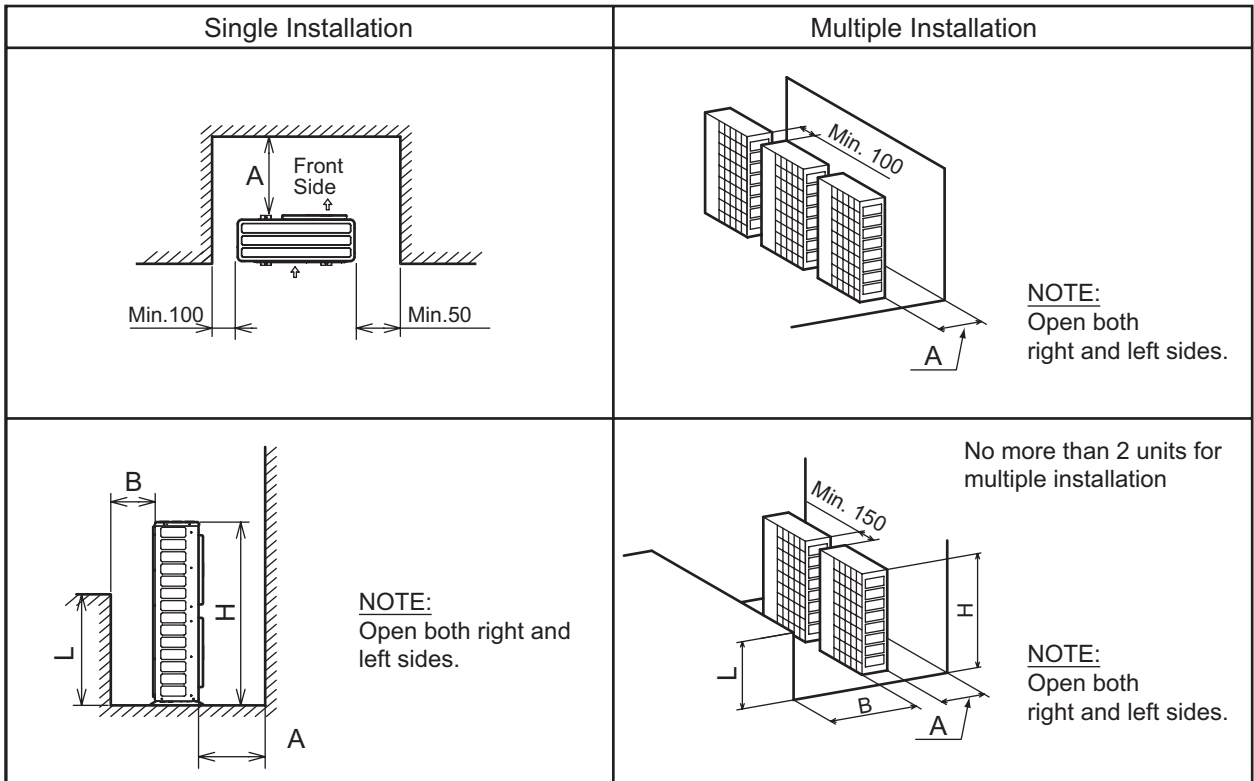

(3) Obstacles in Right and Left

(a) Upper Side is Open.

(mm)

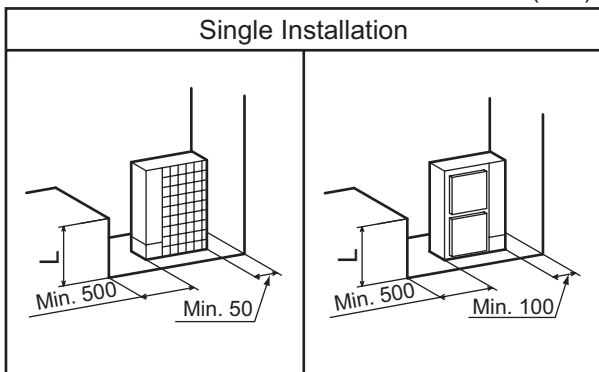

(b) Obstacles in Above

(mm)

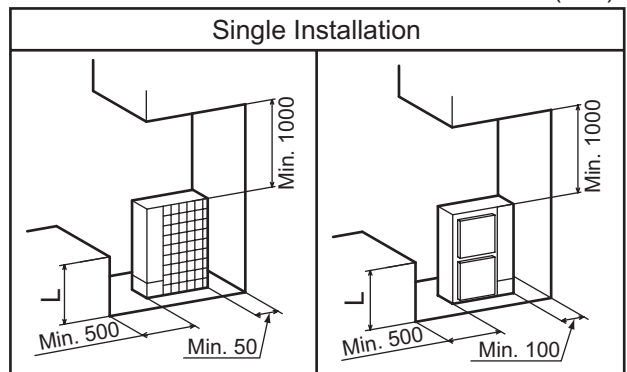

(4) Multi-Row and Multiple Installations

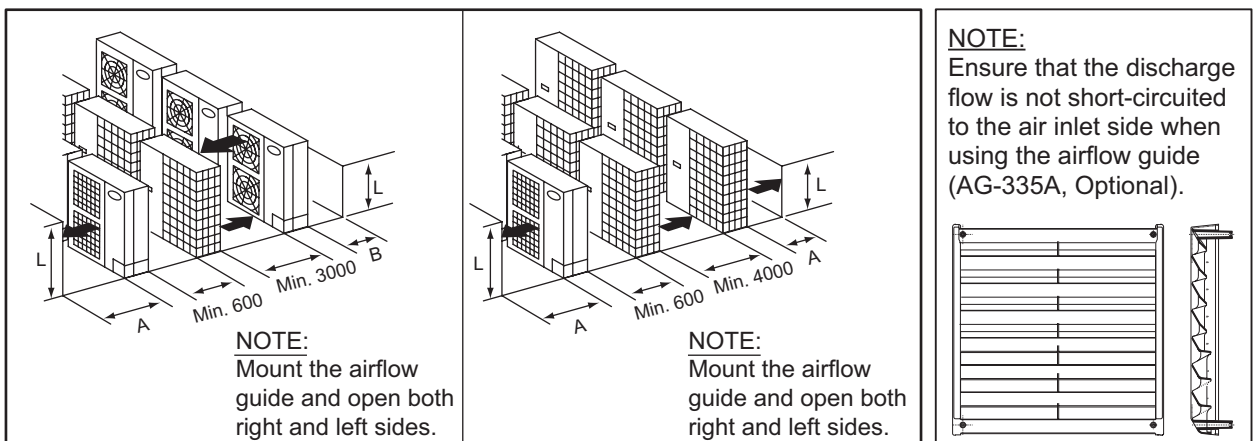

NOTE

- If L is larger than H, mount the units on a base so that H is greater or equal to L.
In this situation ensure that the base is closed and does not allow the airflow to short circuit.
In each case, install the outdoor unit so that the discharge flow is not short-circuited.

L	A	B
$0 < L \leq 1/2H$	600 or more	300 or more
$1/2H < L \leq H$	1400 or more	350 or more

- The airflow guide (Optional) is required when there are interferences in both front and rear side of the outdoor unit.
 - The installation of multi-row and multiple outdoor units should be up to 3 outdoor units on a roof, etc. Use the airflow guide (Optional) in order to prevent short-circuiting if more than 3 outdoor units are installed.
-

4.2 Selection Guide

The various indoor units can be combined with the HITACHI DC Inverter UTOPIA Series. Selection of Unit Model Capacity Procedure is shown below.

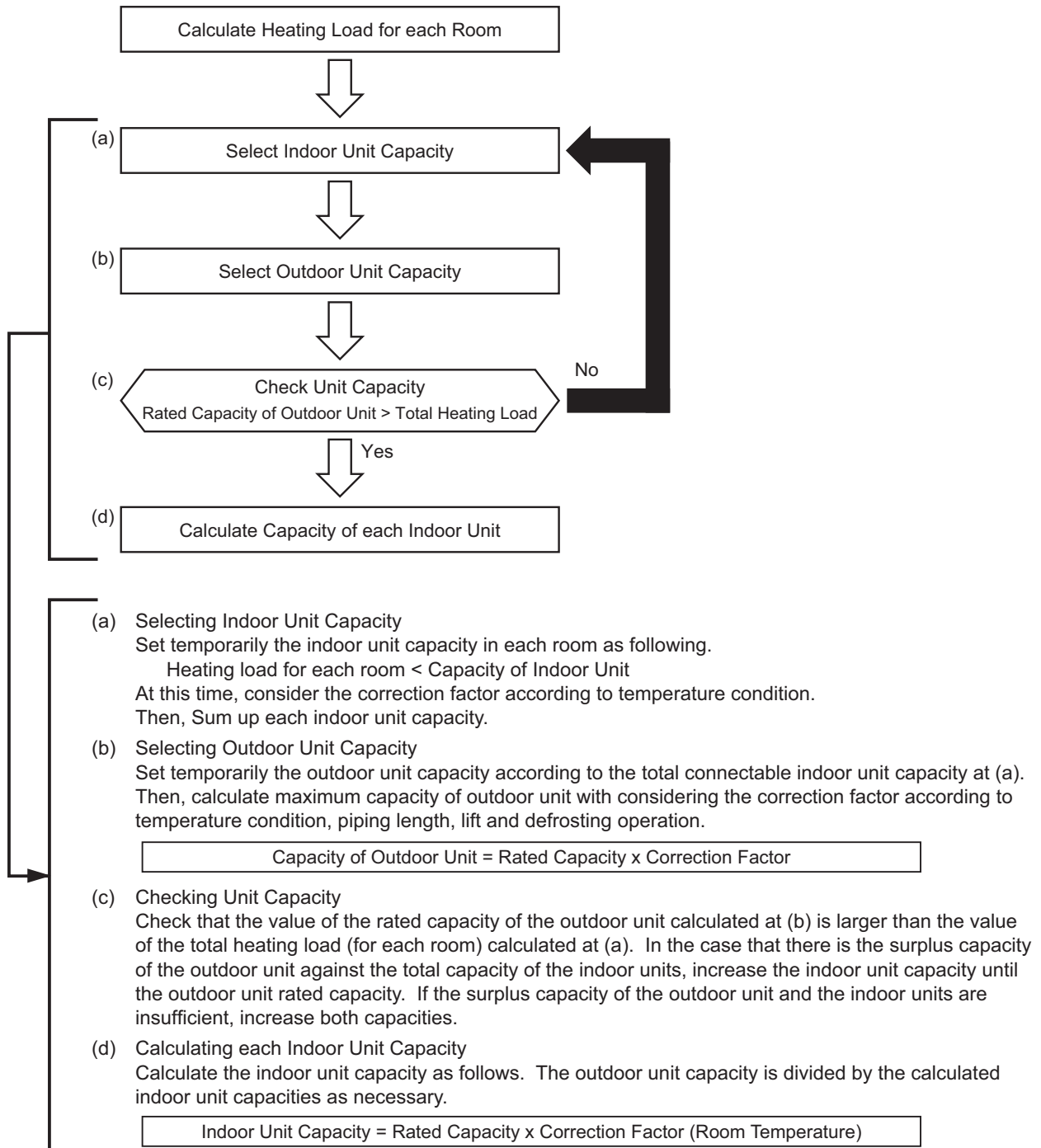

SELECTION DATA

(1) Meaning of Model Name for Indoor Unit

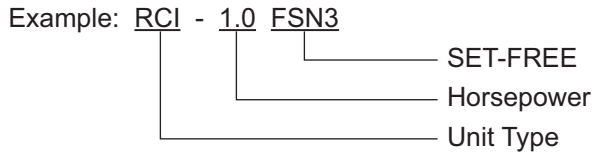

In-the-Ceiling Type	RPI
4-Way Cassette Type	RCI

NOTE:
Select the indoor units and outdoor unit so as the total indoor horsepower is near to the outdoor horsepower.

(2) Nominal Capacity of Indoor Unit

Horsepower (HP)		1.0	1.5	2.0	2.5	3.0	4.0	5.0	6.0	7.0
Cooling Capacity	kW	2.8	4.0	5.0	6.3	7.1	10.0	12.5	14.0	16.0
Heating Capacity	kW	3.2	4.8	5.6	7.5	8.0	11.2	14.0	16.0	18.0

(3) Meaning of Model Name for Outdoor Unit

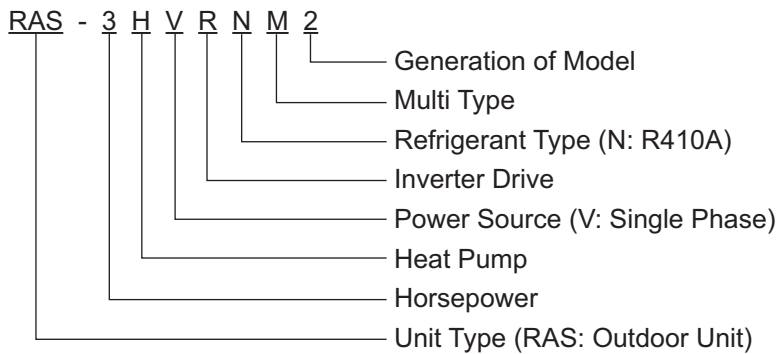

(4) Nominal Capacity of Outdoor Unit

Model		RAS-3HVRNM2	RAS-4HVRNM2	RAS-5HVRNM2	RAS-6HVRNM2	RAS-7HVRNM2
Horsepower (HP)		3	4	5	6	7
Cooling Capacity	kW	7.1	10.0	12.5	14.0	16.0
Heating Capacity	kW	8.0	11.2	14.0	16.0	18.0

Nominal Capacity of Outdoor Unit is under the condition that the total indoor unit horsepower is same as outdoor unit horsepower.

(5) Given Condition (Example)

Total Load for Each Room

Item		Room (1)	Room (2)	Room (3)	(1) + (2) + (3)
Estimated Cooling Load	kW	2.92	3.86	4.88	11.66
Estimated Heating Load	kW	3.29	4.34	5.49	13.12

Temperature Condition

Cooling		Heating	
Outdoor Coil Air Inlet		Outdoor Coil Air Inlet	
Dry Bulb: 30°C		Dry Bulb: 1°C	
Indoor Coil Air Inlet		Wet Bulb: 0°C	
Dry Bulb: 27°C		Indoor Coil Air Inlet	
Wet Bulb: 19°C		Dry Bulb: 20°C	

Equivalent Piping Length between Indoor Units and Outdoor Unit: 60m

Piping Lift: 20m

(6) Selecting Matching Indoor Units and Nominal Capacity

Select 4-Way Cassette Type Indoor Units (Example)

Item		Room (1)	Room (2)	Room (3)	(1) + (2) + (3)
Selected Model		RCI-1.5FSN3	RCI-2.0FSN3	RCI-2.5FSN3	-
Nominal Cooling Capacity	kW	4.0	5.0	7.1	16.1
Nominal Heating Capacity	kW	4.8	5.6	8.0	18.4

(7) Selecting Matching Outdoor Unit

Select Outdoor Unit (Example)

Item		Outdoor Unit
Selected Model		RAS-6HVRNM2
Nominal Cooling Capacity	kW	14.0
Nominal Heating Capacity	kW	16.0

SELECTION DATA

(8) Actual Capacity

In the case of the example, the total indoor horsepower is 6HP and outdoor horsepower is 6HP. Therefore, the outdoor unit capacity at the nominal temperature which is selected from the item 4.3 “Capacity Characteristic Curve” is 16.0kW at the cooling operation, 20.0kW at the heating operation under nominal conditions.

a) Actual Capacity of Outdoor Unit

Maximum Actual Capacity of Outdoor Unit

- = Outdoor Unit Capacity at Nominal Temperature selected from Total Indoor Unit Capacity
- × Correction Factor According to Piping Length and Lift *1)
- × Correction Factor According to Temperature Condition *2)
- × Correction Factor According to Defrosting Operation *3)

*1): Refer to the diagram in item 4.6 “Correction Factor According to Piping Length”.

Correction Factor of Cooling Capacity = 0.84
Correction Factor of Heating Capacity = 0.95

*2): Refer to the table in item 4.4 and 4.5 “Correction Factor According to Temperature Condition”.

Correction Factor of Cooling Capacity = 1.05
Correction Factor of Heating Capacity = 0.87

*3): Refer to the table in item 4.7 “Correction Factor According to Defrosting Operation”

Correction Factor = 0.85

Actual capacity of outdoor unit is

Cooling: $16.0\text{kW} \times 0.84 \times 1.05 = 14.11$
Heating: $20.0\text{kW} \times 0.95 \times 0.87 \times 0.85 = 14.05$

b) Actual Capacity of Each Indoor Unit

Actual Capacity of Each Indoor Unit

= Actual Capacity of Outdoor Unit

- × (Each Indoor Unit's Horsepower ÷ Summation of Each Indoor Unit Horsepower)

ex.

< RCI-1.5FSN3 >

Cooling Capacity: $14.11 \times (1.5\text{HP}/6.0\text{HP}) = 3.53\text{kW}$

Heating Capacity: $14.05 \times (1.5\text{HP}/6.0\text{HP}) = 3.51\text{kW}$

< RCI-2.0FSN3 >

Cooling Capacity: $14.11 \times (2.0\text{HP}/6.0\text{HP}) = 4.70\text{kW}$

Heating Capacity: $14.05 \times (2.0\text{HP}/6.0\text{HP}) = 4.68\text{kW}$

< RCI-2.5FSN3 >

Cooling Capacity: $14.11 \times (2.5\text{HP}/6.0\text{HP}) = 5.88\text{kW}$

Heating Capacity: $14.05 \times (2.5\text{HP}/6.0\text{HP}) = 5.85\text{kW}$

< Result >

Item		Room (1)	Room (2)	Room (3)	(1)+(2)+(3)	
Selected Model		RCI-1.5FSN3	RCI-2.0FSN3	RCI-2.5FSN3	-	
Actual Capacity	Actual Maximum Cooling Capacity	kW	3.53	4.70	5.88	14.11
	Actual Maximum Heating Capacity	kW	3.51	4.68	5.85	14.05
Design Load	Estimated Cooling Load	kW	2.92	3.86	4.88	11.66
	Estimated Heating Load	kW	3.29	4.34	5.49	13.12

4.3 Capacity Characteristic Curve

The following charts show the characteristics of outdoor unit capacity which corresponds with total horsepower of combined indoor unit, on standard condition with refrigerant piping of horizontal and 7.5m at length.

< Cooling Capacity >

• Condition

Indoor Air Inlet Temperature: 27.0°C DB (80.0°F DB), 19.0°C WB (66.2°F WB)

Outdoor Air Inlet Temperature: 35.0°C DB (95.0°F DB)

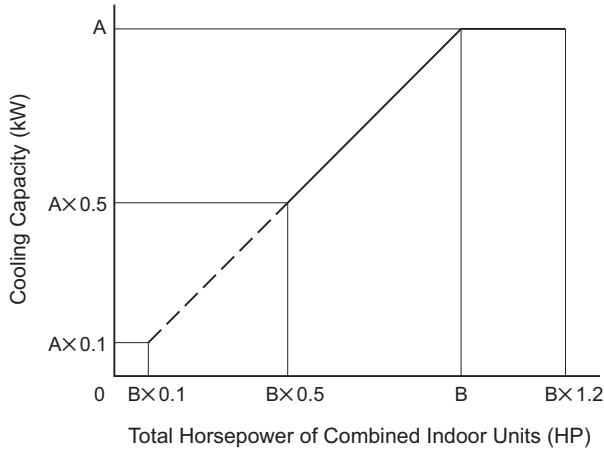

Model	A (kW)	B (HP)
RAS-3HVRNM2	8.0	3
RAS-4HVRNM2	11.2	4
RAS-5HVRNM2	14.0	5
RAS-6HVRNM2	16.0	6
RAS-7HVRNM2	18.0	7

< Heating Capacity >

• Condition

Indoor Air Inlet Temperature: 20.0°C DB (68.0°F DB)

Outdoor Air Inlet Temperature: 7.0°C DB (45.0°F DB), 6.0°C WB (43.0°F WB)

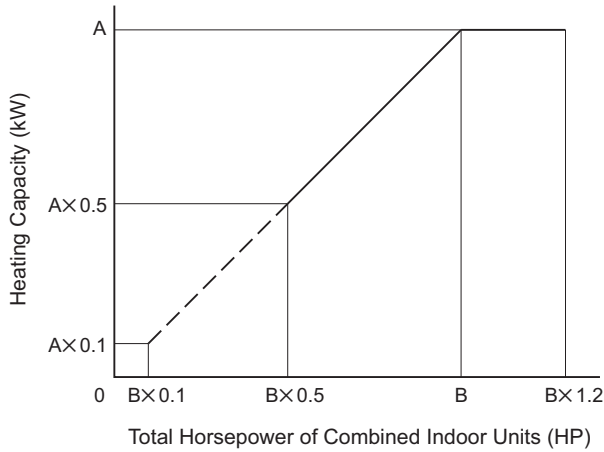

Model	A (kW)	B (HP)
RAS-3HVRNM2	10.6	3
RAS-4HVRNM2	14.0	4
RAS-5HVRNM2	18.0	5
RAS-6HVRNM2	20.0	6
RAS-7HVRNM2	20.0	7

SELECTION DATA

The following shows the examples of outdoor unit capacity which corresponds with total horsepower of combined indoor unit, according to the "Capacity Characteristic Curve" on the previous page.

Table 1. Outdoor Unit Capacity with Total Horsepower of Combined Indoor Unit

Indoor Unit Total (HP)	Outdoor Unit Capacity (kW)									
	RAS-3HVRNM2		RAS-4HVRNM2		RAS-5HVRNM2		RAS-6HVRNM2		RAS-7HVRNM2	
	Cooling	Heating	Cooling	Heating	Cooling	Heating	Cooling	Heating	Cooling	Heating
1.5	4.0	5.3								
1.6	4.3	5.7								
1.7	4.5	6.0								
1.8	4.8	6.4								
1.9	5.1	6.7								
2.0	5.3	7.1	5.6	7.0						
2.1	5.6	7.4	5.9	7.4						
2.2	5.9	7.8	6.2	7.7						
2.3	6.1	8.1	6.4	8.1						
2.4	6.4	8.5	6.7	8.4						
2.5	6.7	8.8	7.0	8.8	7.0	9.0				
2.6	6.9	9.2	7.3	9.1	7.3	9.4				
2.7	7.2	9.5	7.6	9.5	7.6	9.7				
2.8	7.5	9.9	7.8	9.8	7.8	10.1				
2.9	7.7	10.2	8.1	10.2	8.1	10.4				
3.0	8.0	10.6	8.4	10.5	8.4	10.8	8.0	10.0		
3.1	8.0	10.6	8.7	10.9	8.7	11.2	8.3	10.3		
3.2	8.0	10.6	9.0	11.2	9.0	11.5	8.5	10.7		
3.3	8.0	10.6	9.2	11.6	9.2	11.9	8.8	11.0		
3.4	8.0	10.6	9.5	11.9	9.5	12.2	9.1	11.3		
3.5	8.0	10.6	9.8	12.3	9.8	12.6	9.3	11.7		
3.6	8.0	10.6	10.1	12.6	10.1	13.0	9.6	12.0		
3.7			10.4	13.0	10.4	13.3	9.9	12.3		
3.8			10.6	13.3	10.6	13.7	10.1	12.7		
3.9			10.9	13.7	10.9	14.0	10.4	13.0		
4.0			11.2	14.0	11.2	14.4	10.7	13.3		
4.1			11.2	14.0	11.5	14.8	10.9	13.7		
4.2			11.2	14.0	11.8	15.1	11.2	14.0		
4.3			11.2	14.0	12.0	15.5	11.5	14.3		
4.4			11.2	14.0	12.3	15.8	11.7	14.7		
4.5			11.2	14.0	12.6	16.2	12.0	15.0		
4.6			11.2	14.0	12.9	16.6	12.3	15.3		
4.7			11.2	14.0	13.2	16.9	12.5	15.7		
4.8			11.2	14.0	13.4	17.3	12.8	16.0		
4.9					13.7	17.6	13.1	16.3		
5.0					14.0	18.0	13.3	16.7		
5.1					14.0	18.0	13.6	17.0		
5.2					14.0	18.0	13.9	17.3		
5.3					14.0	18.0	14.1	17.7		
5.4					14.0	18.0	14.4	18.0		
5.5					14.0	18.0	14.7	18.3		
5.6					14.0	18.0	14.9	18.7		
5.7					14.0	18.0	15.2	19.0		
5.8					14.0	18.0	15.5	19.3		
5.9					14.0	18.0	15.7	19.7		
6.0					14.0	18.0	16.0	20.0		
6.1							16.0	20.0		
6.2							16.0	20.0		
6.3							16.0	20.0		
6.4							16.0	20.0		
6.5							16.0	20.0		
6.6							16.0	20.0		
6.7							16.0	20.0		
6.8							16.0	20.0		
6.9							16.0	20.0		
7.0							16.0	20.0	18.0	20.0
7.1							16.0	20.0		
7.2							16.0	20.0		

4.4 Correction Factor According to Temperature Condition (Cooling)

Correction Factor for RAS-3HVRNM2 (Connected Indoor Unit: 100%)

Outdoor Air Inlet	Indoor Air Inlet Wet Bulb (°C)					
Dry Bulb (°C)	16.0	18.0	19.0	20.0	22.0	23.0
25.0	0.99	1.05	1.08	1.11	1.16	1.18
30.0	0.97	1.02	1.05	1.07	1.13	1.15
35.0	0.93	0.98	1.00	1.03	1.09	1.12
40.0	0.88	0.94	0.96	0.99	1.04	1.06

Correction Factor for RAS-4HVRNM2 (Connected Indoor Unit: 100%)

Outdoor Air Inlet	Indoor Air Inlet Wet Bulb (°C)					
Dry Bulb (°C)	16.0	18.0	19.0	20.0	22.0	23.0
25.0	0.97	1.03	1.05	1.08	1.14	1.17
30.0	0.95	1.00	1.03	1.05	1.11	1.14
35.0	0.92	0.97	1.00	1.03	1.08	1.10
40.0	0.89	0.95	0.97	1.00	1.04	1.06

Correction Factor for RAS-5HVRNM2 (Connected Indoor Unit: 100%)

Outdoor Air Inlet	Indoor Air Inlet Wet Bulb (°C)					
Dry Bulb (°C)	16.0	18.0	19.0	20.0	22.0	23.0
25.0	0.99	1.05	1.08	1.11	1.16	1.20
30.0	0.94	1.01	1.04	1.08	1.14	1.17
35.0	0.92	0.97	1.00	1.03	1.10	1.13
40.0	0.87	0.92	0.95	0.98	1.04	1.12

Correction Factor for RAS-6HVRNM2 (Connected Indoor Unit: 100%)

Outdoor Air Inlet	Indoor Air Inlet Wet Bulb (°C)					
Dry Bulb (°C)	16.0	18.0	19.0	20.0	22.0	23.0
25.0	1.03	1.06	1.08	1.10	1.16	1.19
30.0	1.01	1.03	1.05	1.08	1.13	1.16
35.0	0.96	0.98	1.00	1.03	1.09	1.13
40.0	0.91	0.93	0.96	0.98	1.03	1.10

Correction Factor for RAS-7HVRNM2 (Connected Indoor Unit: 100%)

Outdoor Air Inlet	Indoor Air Inlet Wet Bulb (°C)					
Dry Bulb (°C)	16.0	18.0	19.0	20.0	22.0	23.0
25.0	0.99	1.05	1.08	1.12	1.19	1.23
30.0	0.95	1.01	1.04	1.07	1.15	1.18
35.0	0.91	0.97	1.00	1.03	1.10	1.13
40.0	0.86	0.92	0.95	0.98	1.03	1.05

NOTE:

- The table shows the normal value of cooling operation.
In some cases, the value may change due to the compressor protection control.
- The cooling capacity on the table indicates the peak value, which does not include the capacity decrease caused by frost.
- The value on the table shows when the system is operated under the following conditions.
The indoor unit total capacity: 100% of outdoor unit capacity, The total piping length: 7.5m,
The height difference: 0m

SELECTION DATA

4.5 Correction Factor According to Temperature Condition (Heating)

Correction Factor for RAS-3HVRNM2 (Connected Indoor Unit: 100%)

Outdoor Air Inlet Wet Bulb (°C)	Indoor Air Inlet Dry Bulb (°C)					
	16.0	18.0	20.0	21.0	22.0	24.0
-20.0	0.51	0.51	0.51	0.51	0.50	0.50
-15.0	0.61	0.60	0.60	0.59	0.59	0.59
-10.0	0.71	0.70	0.70	0.69	0.69	0.68
-5.0	0.80	0.80	0.80	0.79	0.79	0.78
0.0	0.90	0.89	0.88	0.88	0.87	0.87
5.0	1.00	0.99	0.98	0.97	0.97	0.96
6.0	1.01	1.00	1.00	1.00	0.99	0.98
10.0	1.11	1.10	1.09	1.09	1.08	1.07
15.0	1.24	1.22	1.21	1.21	1.21	1.19

Correction Factor for RAS-4HVRNM2 (Connected Indoor Unit: 100%)

Outdoor Air Inlet Wet Bulb (°C)	Indoor Air Inlet Dry Bulb (°C)					
	16.0	18.0	20.0	21.0	22.0	24.0
-20.0	0.60	0.59	0.57	0.56	0.55	0.53
-15.0	0.68	0.67	0.65	0.65	0.64	0.63
-10.0	0.76	0.75	0.74	0.73	0.73	0.71
-5.0	0.84	0.83	0.82	0.81	0.80	0.79
0.0	0.92	0.91	0.90	0.90	0.89	0.87
5.0	1.00	0.99	0.98	0.98	0.97	0.96
6.0	1.01	1.00	1.00	0.99	0.99	0.98
10.0	1.10	1.10	1.10	1.09	1.09	1.07
15.0	1.21	1.21	1.21	1.21	1.21	1.19

Correction Factor for RAS-5HVRNM2 (Connected Indoor Unit: 100%)

Outdoor Air Inlet Wet Bulb (°C)	Indoor Air Inlet Dry Bulb (°C)					
	16.0	18.0	20.0	21.0	22.0	24.0
-20.0	0.60	0.60	0.59	0.58	0.58	0.57
-15.0	0.67	0.67	0.66	0.65	0.65	0.64
-10.0	0.75	0.74	0.73	0.73	0.72	0.71
-5.0	0.83	0.82	0.81	0.81	0.80	0.80
0.0	0.90	0.89	0.88	0.87	0.87	0.86
5.0	0.98	0.98	0.97	0.96	0.96	0.95
6.0	1.01	1.01	1.00	1.00	0.99	0.98
10.0	1.12	1.11	1.10	1.09	1.09	1.08
15.0	1.24	1.23	1.22	1.21	1.20	1.19

Correction Factor for RAS-6HVRNM2 (Connected Indoor Unit: 100%)

Outdoor Air Inlet Wet Bulb (°C)	Indoor Air Inlet Dry Bulb (°C)					
	16.0	18.0	20.0	21.0	22.0	24.0
-20.0	0.57	0.56	0.55	0.55	0.54	0.53
-15.0	0.64	0.63	0.63	0.62	0.62	0.61
-10.0	0.72	0.71	0.70	0.70	0.70	0.69
-5.0	0.81	0.80	0.80	0.79	0.79	0.78
0.0	0.88	0.88	0.87	0.86	0.86	0.86
5.0	0.97	0.97	0.96	0.96	0.96	0.96
6.0	1.00	1.00	1.00	1.00	1.00	0.99
10.0	1.09	1.07	1.07	1.06	1.05	1.03
15.0	1.17	1.16	1.15	1.12	1.09	1.03

Correction Factor for RAS-7HVRNM2 (Connected Indoor Unit: 100%)

Outdoor Air Inlet Wet Bulb (°C)	Indoor Air Inlet Dry Bulb (°C)					
	16.0	18.0	20.0	21.0	22.0	24.0
-20.0	0.49	0.48	0.48	0.48	0.47	0.47
-15.0	0.57	0.57	0.57	0.57	0.57	0.56
-10.0	0.67	0.66	0.66	0.65	0.65	0.65
-5.0	0.76	0.76	0.75	0.75	0.75	0.74
0.0	0.88	0.87	0.87	0.86	0.86	0.85
5.0	0.99	0.98	0.98	0.97	0.97	0.96
6.0	1.01	1.00	1.00	0.99	0.99	0.98
10.0	1.12	1.12	1.11	1.11	1.10	1.09
15.0	1.16	1.16	1.15	1.14	1.12	1.10

NOTE:

1. The table shows the normal value of heating operation.
In some cases, the value may change due to the compressor protection control.
2. The heating capacity on the table indicates the peak value, which does not include the capacity decrease caused by frost.
3. The value on the table shows when the system is operated under the following conditions.
The indoor unit total capacity: 100% of outdoor unit capacity, The total piping length: 7.5m,
The height difference: 0m

SELECTION DATA

4.6 Correction Factor According to Piping Length

< Cooling Capacity >

Correction Factor for Cooling Capacity According to Piping Length

The correction factors are shown in the following figure.

Equivalent Piping Length for

- One 90° Elbow is 0.5m.
- One 180° Bend is 1.5m.
- One Multi-Kit is 0.5m.

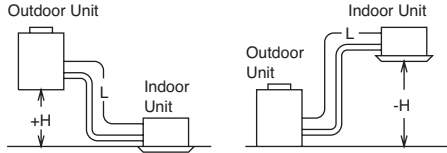

H: Vertical Distance Between Indoor Unit and Outdoor Unit in Meters

EL: Equivalent Total Distance Between Indoor Unit and Outdoor Unit in Meters (Equivalent One-Way Piping Length)

H>0: Position of Outdoor Unit Higher Than Position of Indoor Unit

L: Actual One-Way Piping Length Between Indoor Unit and Outdoor Unit in Meters

• RAS-3HVRNM2

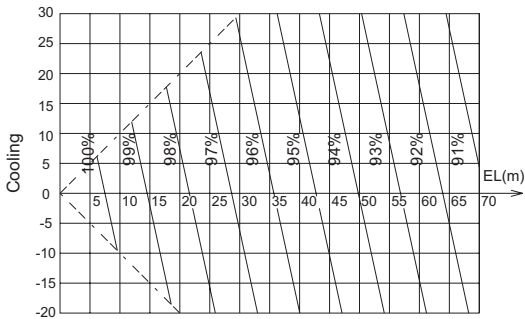

• RAS-4HVRNM2

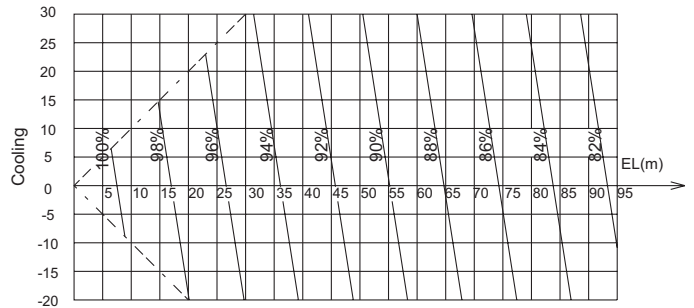

• RAS-5HVRNM2

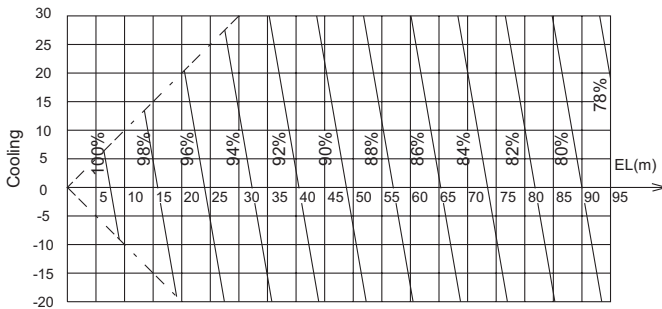

• RAS-6HVRNM2

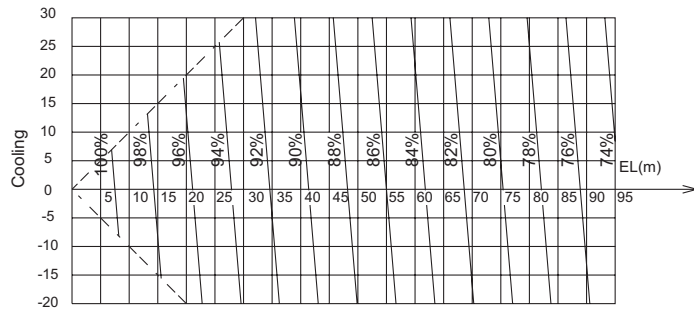

• RAS-7HVRNM2

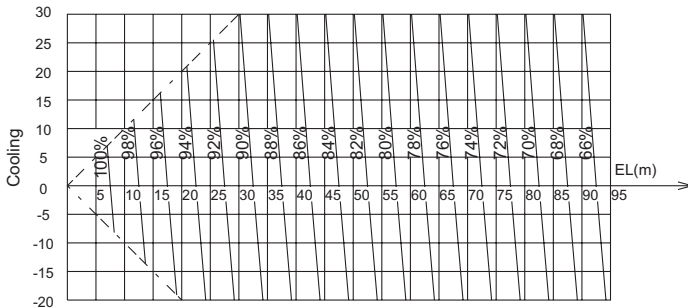

< Heating Capacity >

Correction Factor for Heating Capacity According to Piping Length
 The correction factors are shown in the following figure.

Equivalent Piping Length for

- One 90° Elbow is 0.5m.
- One 180° Bend is 1.5m.
- One Multi-Kit is 0.5m.

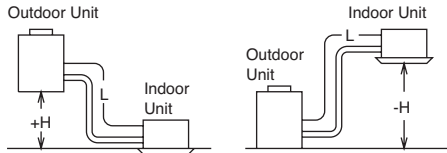

H: Vertical Distance Between Indoor Unit and Outdoor Unit in Meters

EL: Equivalent Total Distance Between Indoor Unit and Outdoor Unit in Meters (Equivalent One-Way Piping Length)

H>0: Position of Outdoor Unit Higher Than Position of Indoor Unit

L: Actual One-Way Piping Length Between Indoor Unit and Outdoor Unit in Meters

• RAS-3HVRNM2

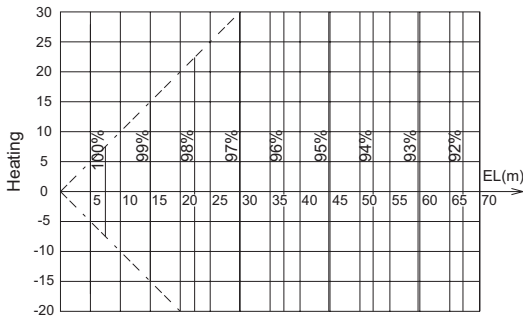

• RAS-4HVRNM2

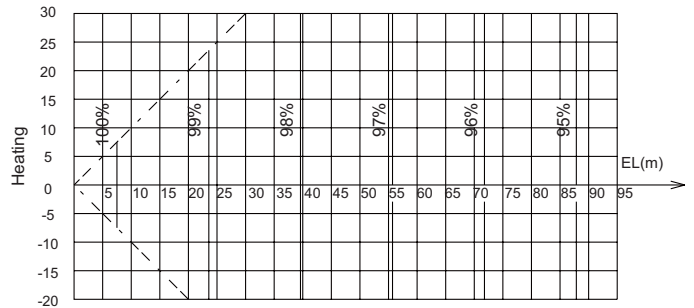

• RAS-5HVRNM2

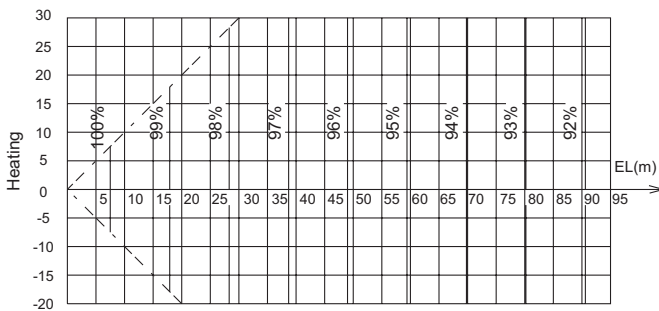

• RAS-6HVRNM2

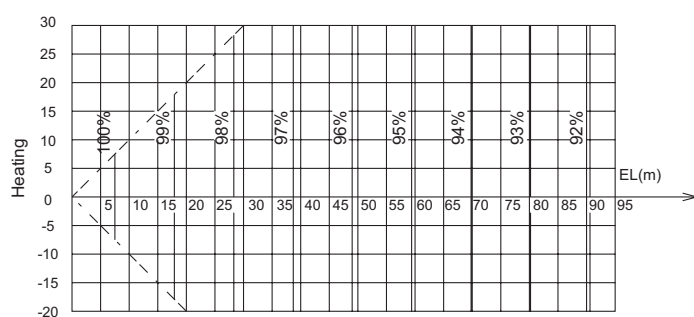

• RAS-7HVRNM2

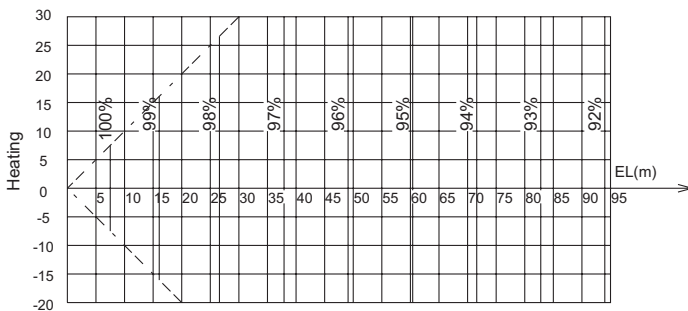

SELECTION DATA

4.7 Correction Factor According to Defrosting Operation

The heating capacity in the preceding paragraph, excludes the condition of the frost or the defrosting operation period.

In consideration of the frost or the defrosting operation, the heating capacity is corrected by the equation below.

Corrected Heating Capacity = Correction Factor × Heating Capacity

Outdoor Inlet Air Temp. (°C DB) (Humidity=85% RH)	-7	-5	-3	0	3	5	7
Correction Factor	0.95	0.93	0.88	0.85	0.87	0.90	1.0

NOTE:

The correction factor is not available for the special condition like a snowfall or a operation in a transitional period.

4.8 Fan Performance

< RPI-3.0FSN2SQ >

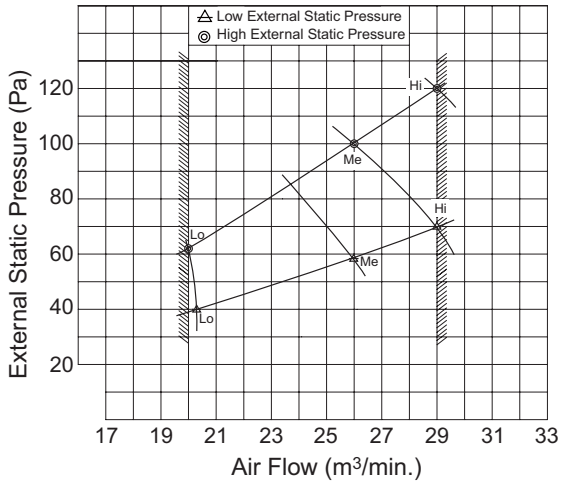

< RPI-4.0FSN2SQ >

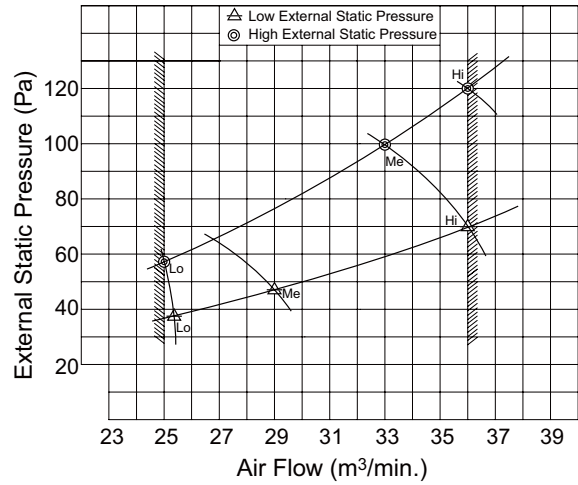

< RPI-5.0FSN2SQ >

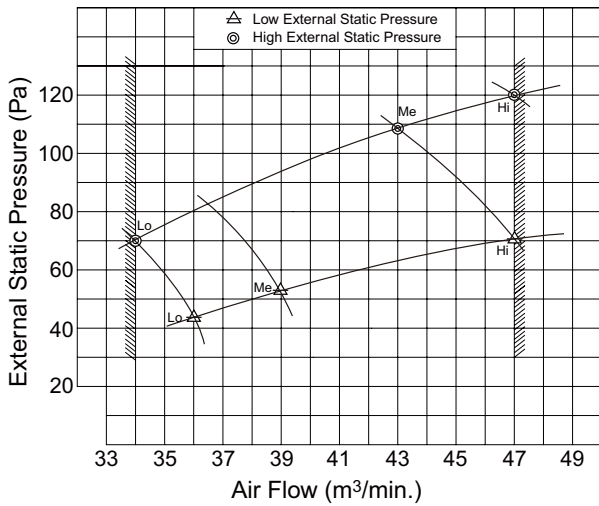

< RPI-6.0FSN2SQ >

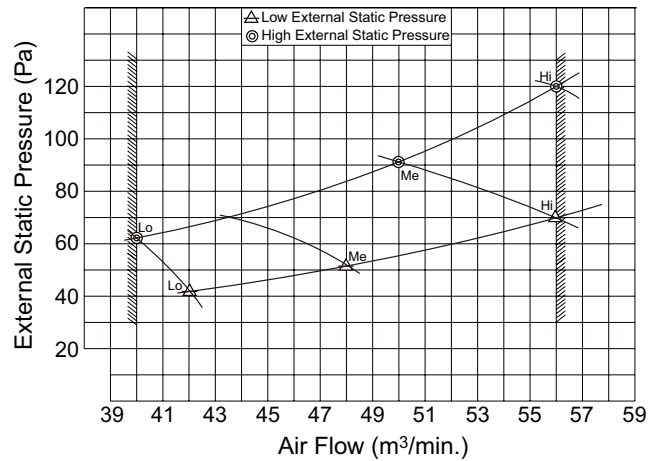

< RPI-7.0FSN2SQ >

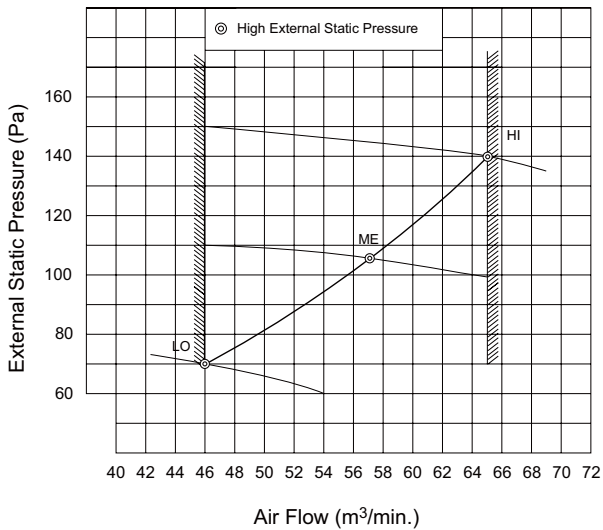

5. Electrical Data

< Indoor Unit (220-240V/50Hz) >

Model		Unit Main Power			Applicable Voltage		Indoor Fan Motor		
		VOL	PH	HZ	Maximum	Minimum	PH	RNC	IPT
In-the-Ceiling (Duct) Type	RPI-3.0FSN2SQ	240	1	50	264	216	1	1.5	0.35
	RPI-4.0FSN2SQ							1.7	0.39
	RPI-5.0FSN2SQ							2.8	0.65
	RPI-6.0FSN2SQ							3.0	0.71
	RPI-7.0FSN2SQ							4.8	1.15
4-Way Cassette Type	RCI-1.0FSN3	220/240	1	50	264	198	1	0.2/0.2	0.04
	RCI-1.5FSN3							0.3/0.3	0.06
	RCI-2.0FSN3							0.4/0.4	0.08
	RCI-2.5FSN3							0.8/0.7	0.15
	RCI-3.0FSN3							0.8/0.7	0.15
	RCI-4.0FSN3							1.0/0.9	0.18
	RCI-5.0FSN3							1.1/1.0	0.20
	RCI-6.0FSN3							1.1/1.0	0.20

< Indoor Unit (220V/60Hz) >

Model		Unit Main Power			Applicable Voltage		Indoor Fan Motor		
		VOL	PH	HZ	Maximum	Minimum	PH	RNC	IPT
4-Way Cassette Type	RCI-1.0FSN3	220	1	60	242	198	1	0.2	0.04
	RCI-1.5FSN3							0.3	0.06
	RCI-2.0FSN3							0.4	0.08
	RCI-2.5FSN3							0.8	0.15
	RCI-3.0FSN3							0.8	0.15
	RCI-4.0FSN3							1.0	0.18
	RCI-5.0FSN3							1.1	0.20
	RCI-6.0FSN3							1.1	0.20

< Outdoor Unit (220-240V/50Hz, 220V/60Hz) >

Model	Unit Main Power			Applicable Voltage		Compressor Motor						Maximum Current
	VOL	PH	HZ	Maximum	Minimum	PH	STC	Cooling Operation		Heating Operation		
								RNC	IPT	RNC	IPT	
RAS-3HVRNM2	220/240	1	50	264	198	3	-	7.9/7.3	1.69	7.4/6.8	1.58	23
RAS-4HVRNM2								9.7/8.9	2.12	8.5/7.8	1.86	32
RAS-5HVRNM2								13.8/12.6	3.00	11.0/10.1	2.40	32
RAS-6HVRNM2								16.0/14.7	3.49	14.3/13.1	3.12	32
RAS-7HVRNM2								16.6/15.2	3.61	14.4/13.2	3.13	32

VOL: Rated Unit Power Supply Voltage (Plated)(V)
 HZ: Frequency (Hz)
 STC: Starting Current (A)

RNC: Running Current (A)
 PH: Phase (φ)
 IPT: Input (kW)

NOTES:

1. The above performance data is based on 7.5m equivalent piping length and 0m piping lift.
2. These data are based on the same conditions as the nominal heating and cooling capacities.
3. The compressor is started by an inverter, resulting in extremely low starting current.

6. Sound Data

< In-the-Ceiling (Duct) Type >

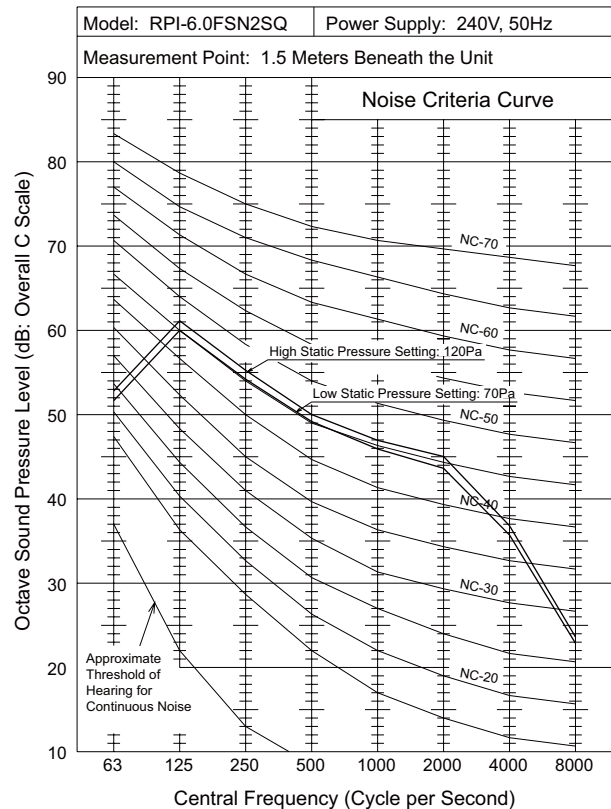
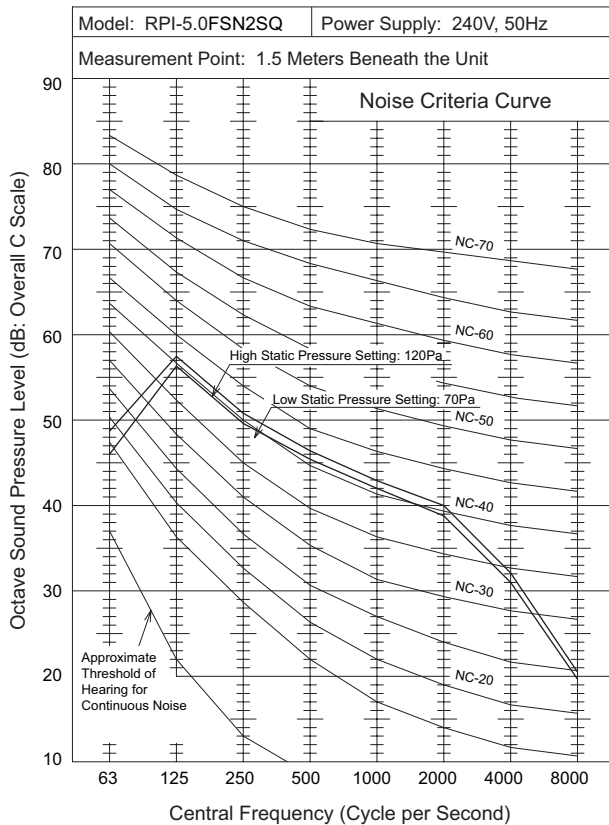
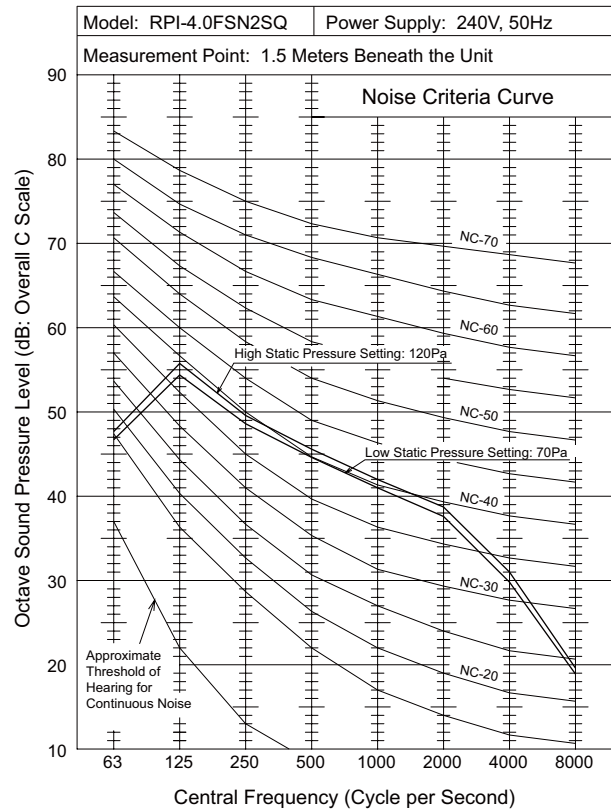
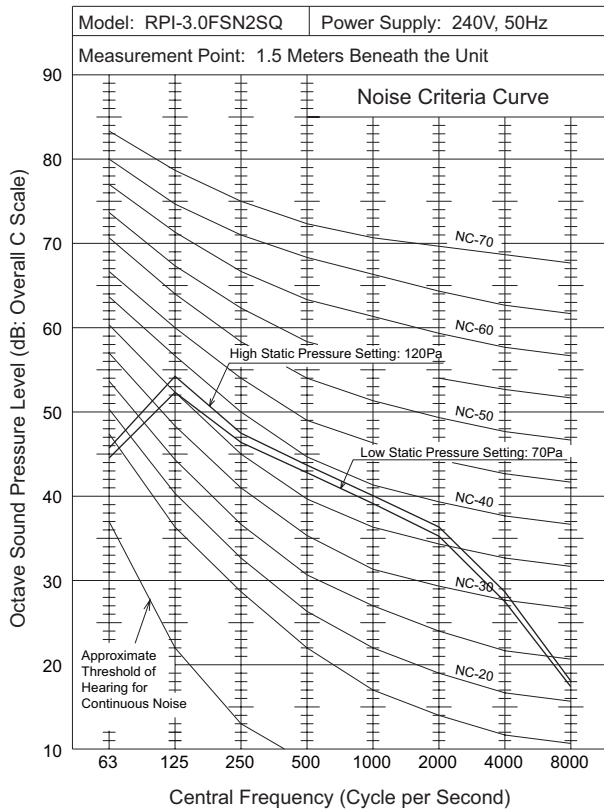

SOUND DATA

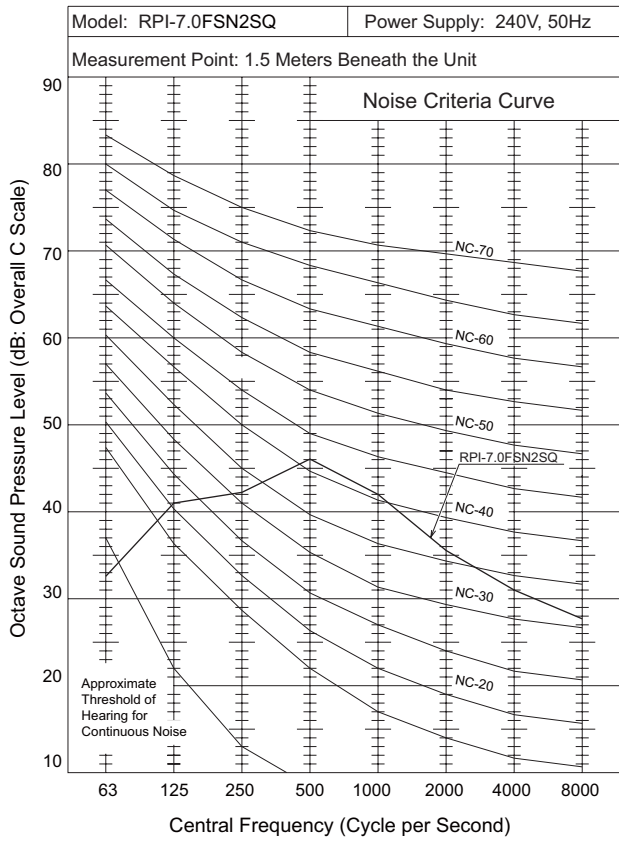

< Outdoor Units >

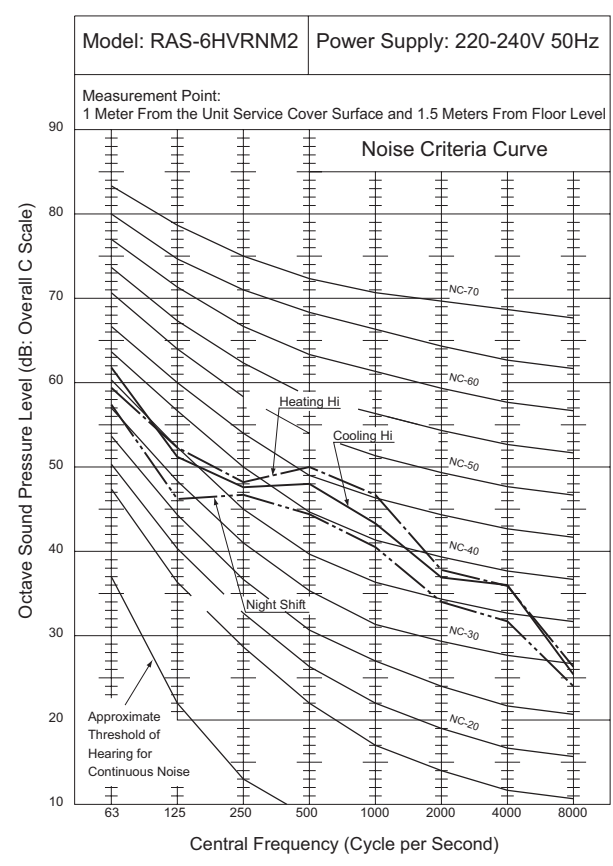
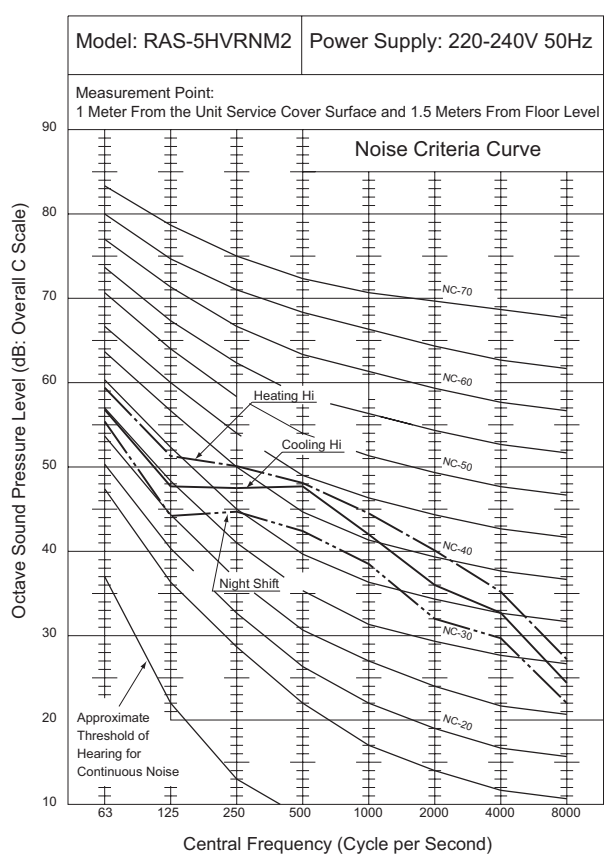
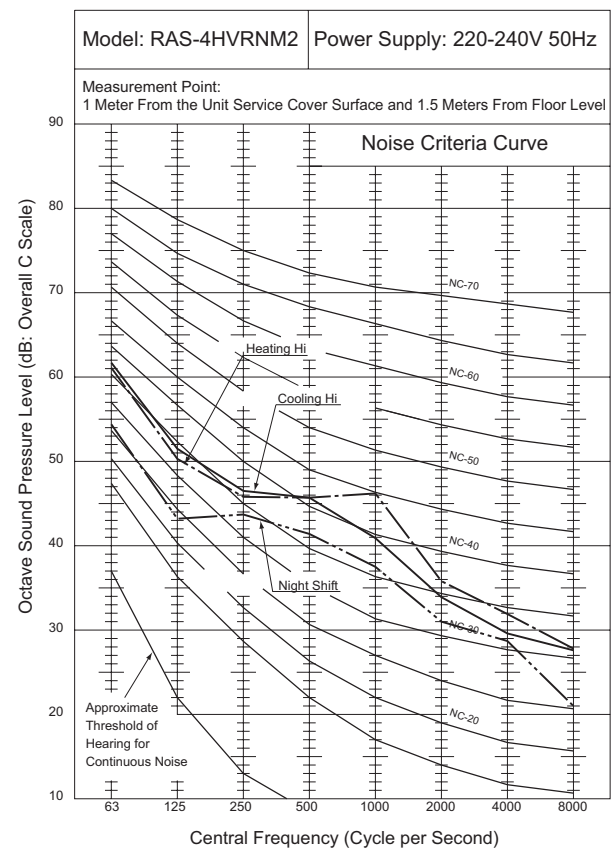
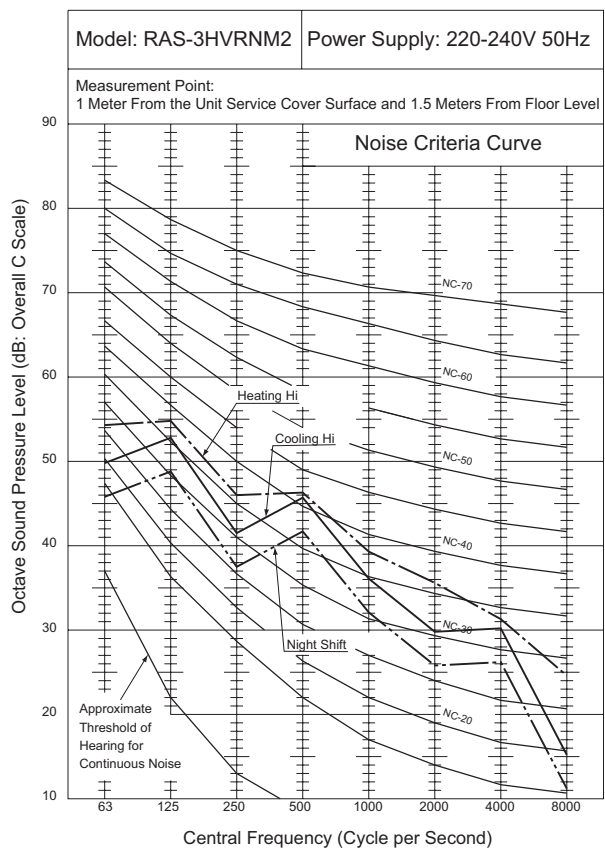

SOUND DATA

Model: RAS-7HVRNM2 Power Supply: 220-240V 50Hz

Measurement Point:
1 Meter From the Unit Service Cover Surface and 1.5 Meters From Floor Level

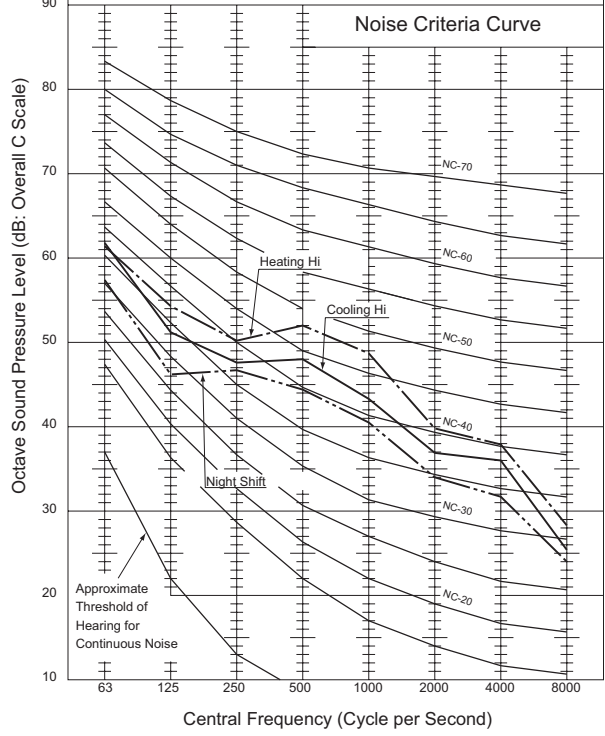

7. Working Range

Power Supply

Working Voltage: 90% to 110% of the Rated Voltage
 Voltage Imbalance: Within a 3% Deviation from Each Voltage at the Main Terminal
 Starting Voltage: Higher than 85% of the Rated Voltage

Temperature Range

The temperature range are given in the following table.

		Cooling Operation	Heating Operation
Indoor Temperature	Minimum	21°C DB / 15°C WB	15°C DB
	Maximum	32°C DB / 23°C WB	27°C DB
Outdoor Temperature	Minimum	-5°C DB	-20°C WB
	Maximum	46°C DB	15°C WB

DB: Dry Bulb, WB: Wet Bulb

Piping Provision

- Maximum Piping Length Lo-:
 - "A" in Actual Length (On Way for Indoor Unit)
- Maximum Piping Lift between Outdoor Unit and Indoor Unit Ho-:
 - 30m When Outdoor Unit is Higher than Indoor Unit
 - 20m When Indoor Unit is Higher than Outdoor Unit
- Maximum Piping Lift between Indoor Units Hi-:
 - 10m

Model	A
RAS-3HVRNM2	50m
RAS-4HVRNM2 to 7HVRNM2	75m