

# ISD 310KB-P

## Ducted Split System Indoor Units

## Installation & Maintenance

### GENERAL

These ISD 310KB-P indoor unit is designed to be coupled with the OSA 310RKTBV outdoor unit. Units must be installed in accordance with all national and local safety codes.

There are two versions available:

1. **ISD 310KBH-P** – horizontal discharge
2. **ISD 310KBV-P** – vertical discharge

### Options

1. Filter Box c/w polypropylene net filter
2. Spring Mounting Kit

### UNPACKING

For shipping purposes the ISD 310KB-P vertical discharge version is supplied with its supply air spigot installed in the horizontal position. Unscrew the spigot and relocate to the top of the unit prior to installation.

### AIR FILTRATION / FILTER BOX (Option)

As air filtration requirements vary, filters are not supplied with the unit. Filters should ideally be installed on the return air side of the unit, no closer than 500mm from the back of the unit and easily accessible for

cleaning. To maximise the efficiency of air flow, the return air filter should be twice the area of the ISD unit's return air spigot/s. If efficiency is less of a concern a Filter Box is available.

The Filter Box is installed by unscrewing the return air spigot and replacing it with the filter box. The three filter panels may be accessed from either side of the box. The filter box adds 90 mm to the depth of the unit.

### INSTALLATION

#### Positioning & Mounting

Provide 600 mm minimum clearance to both end panels. If the filter box option is to be used, allow adequate clearance for the three filters to be withdrawn from either side of the unit.

If low noise is a critical factor in the installation, refer to Figure 5 for noise isolation recommendations.

It is recommended that the unit be mounted using the spring mounting system, supplied as an optional extra (Fig.3). This system minimises transfer of vibration into the building structure.

If a more rigid installation can be tolerated, then suspend the unit using the four mounting straps supplied, as shown in Figure 4. Use the existing bolts, nuts & washers at the top corners of the unit.

Alternatively, the unit can be mounted on a suitable platform using vibration isolators.

The unit must be installed with the drain tray tilted about 10 mm along its length so that the drain connection is at the lowest point.

### Condensate Drain

The condensate drain should be trapped outside the unit cabinet. The trap should have a vertical height of at least 50 mm. The drain should have a slope of at least 1 in 50 and must not be piped to a level above the unit drain tray (refer Fig.2).

For long condensate pipe runs, fit a vent pipe near the drain trap. The top of the vent pipe must be at least 100 mm above the ISD unit's drain tray.

It is essential that the drainage system for the evaporator is checked by pouring water in the drain tray and seeing that it discharges at the end of the drain and does not overflow the drain tray.

**Fig.1 Dimensions (mm)**

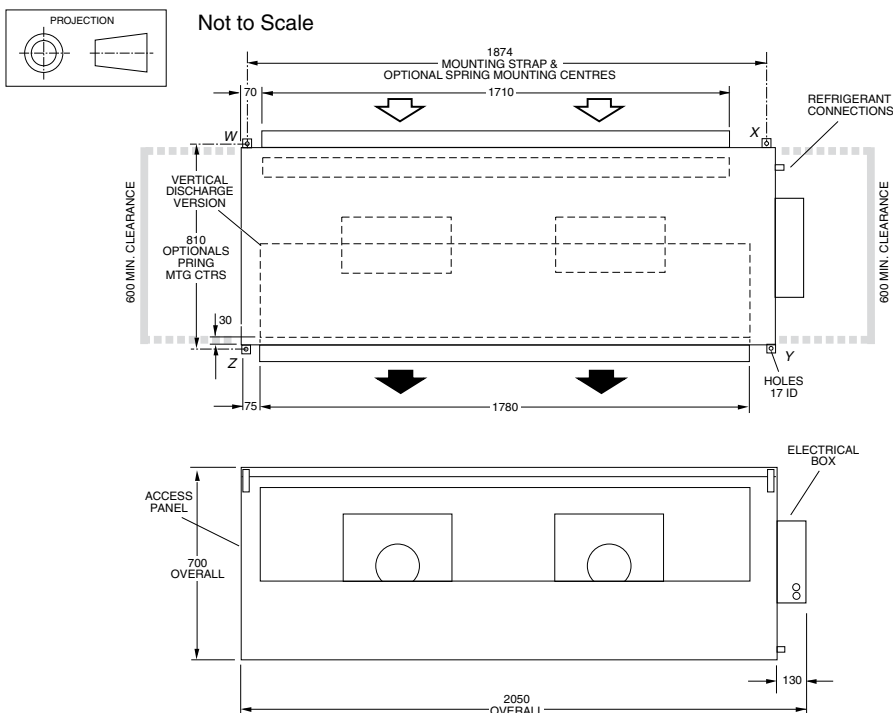

ISD 310KBH-P shown here

| CORNER LOADS (kg) |    |    |    |
|-------------------|----|----|----|
| W                 | X  | Y  | Z  |
| 42                | 47 | 35 | 38 |

Net Weight 162 kg

**Note:** The manufacturer reserves the right to change specifications at any time without notice or obligation. Certified dimensions available on request.

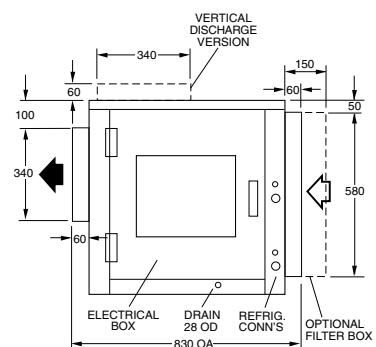

## INDOOR-OUTDOOR UNIT CONNECTIONS

Refer to the relevant OSA Outdoor Unit 'Installation & Maintenance' pamphlet for piping instructions. For wiring connections, refer to the Outdoor Unit wiring diagram in conjunction with the ISD wiring diagram on this pamphlet.

## REFRIGERATION PIPING

### Pipe Connection Sizes & Type

Liquid : 13 mm OD ( $\frac{1}{2}$ " ) sweat

Suction : 22 mm OD ( $\frac{7}{8}$ " ) sweat

The ISD is shipped from the factory with a pressurised holding charge of nitrogen. Immediately before removing any brazed pipe connection's seal, reduce holding charge to atmospheric pressure.

**Warning:** Failure to do so may cause injury.

Refer to the Outdoor Unit 'Installation & Maintenance' pamphlet for evacuation procedure and piping requirements.

## ELECTRICAL WIRING

The electrical supply required (via the Outdoor Unit) is specified on the Outdoor Unit's wiring diagram.

Electrical work must be carried out by a qualified electrician in accordance with local supply authority regulations and the wiring diagram.

In a free blow or low resistance application, beware of exceeding the fan motor's full load amp limit (refer Outdoor Unit's wiring diagram).

To make the indoor fan switch off during de-ice cycle, refer to the Outdoor Unit wiring diagram for the appropriate changes.

## INDOOR FAN SPEED

The fan speed is continuously variable via the 0-10V DC control signal applied between terminals 'FAN GND' and '0-10V'.

Once the maximum design air flow has been set (refer Commissioning), the fan speed can be controlled as follows:

### 1. ON/OFF

a.) Connect 24V a.c. control signal to either 'LOW 24V', 'MED 24V' or 'HIGH 24V', and 'COM 24V', or

b) Wire a N/O control relay contact (or switch) between 'FAN 10V' and '0-10V'.

### 2. Variable Speed

Apply an external variable 0-10V DC control voltage to '0-10V' terminal.

Connect 0V reference to 'FAN GND'.

Fig. 2

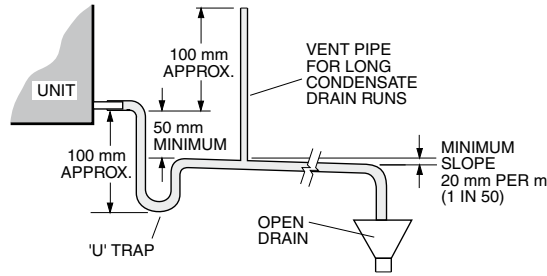

## Condensate Drain

Fig. 3 Spring Mounting

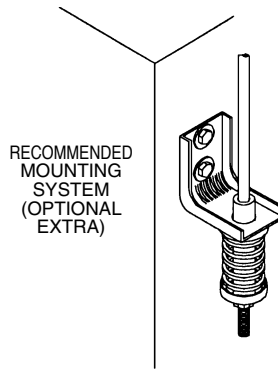
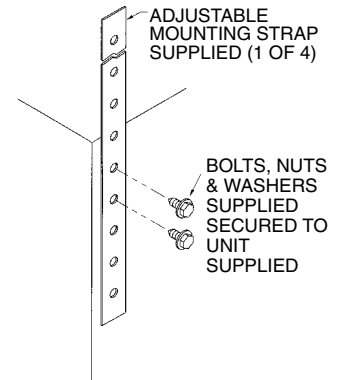

Fig. 4 Strap Mounting



## COMMISSIONING

### Indoor Unit

1. Check that the thermostat is correctly wired and set at the desired temperature.
2. Link terminals 'FAN 10V' to '0-10V'. Adjust the 'POT' to deliver your maximum design air flow. Remove link 'FAN 10V' to '0-10V' when fan speed has been set.
3. Check that any air filter (if fitted) is clean.
4. Check that the fan runs freely without vibration.
5. Check condensate drain for free drainage.
6. Run the unit in cooling and heating modes.

## MAINTENANCE

### Weekly For First Four Weeks

1. Check air filter (if fitted); vacuum clean as necessary.
2. Check condensate drain for free drainage.

### Monthly

Check air filter (if fitted); vacuum clean as necessary.

## Six Monthly

1. Check condensate drain for free drainage.
2. Check heat exchanger coil; vacuum or brush clean as necessary.
3. Check the tightness of the fan.
4. Check that fan motor is free running.
5. Check tightness of electrical connections.
6. Check air supply at diffuser outlets.

## NOTE

The manufacturer reserves the right to change specifications at any time without notice or obligation. Certified dimensions available on request.

This pamphlet replaces the previous issue no. 3699 dated 10/11.  
Wiring revision A.

## Fig. 5 Application Considerations

### Recommendations for Noise Isolation - particularly for high static installations:

1. Avoid installing units, with non-ducted return air, directly above spaces where noise is critical.
2. Use flexible connections between unit and rigid ducting.
3. Use generously sized acoustically lined ducts.
4. If generous duct size is not possible, use turning vanes on bends to reduce air turbulence (regenerated noise).
5. Use 90° bends in ducting to significantly assist in noise reduction.

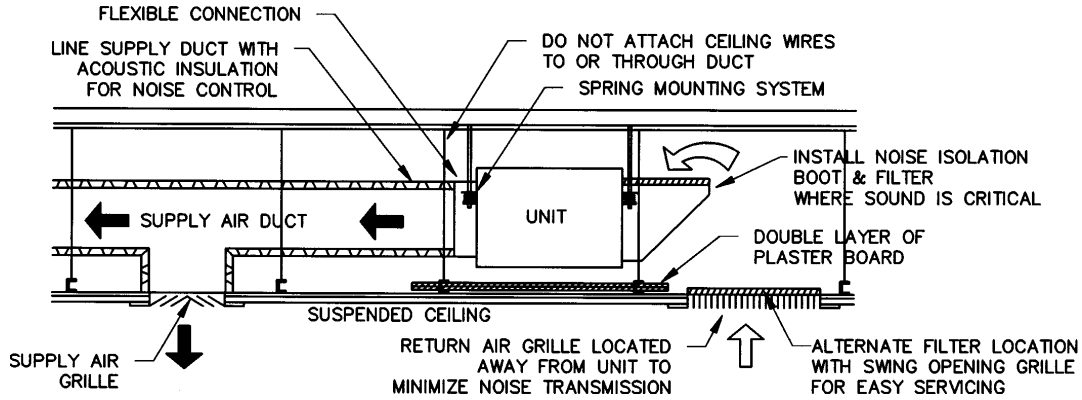
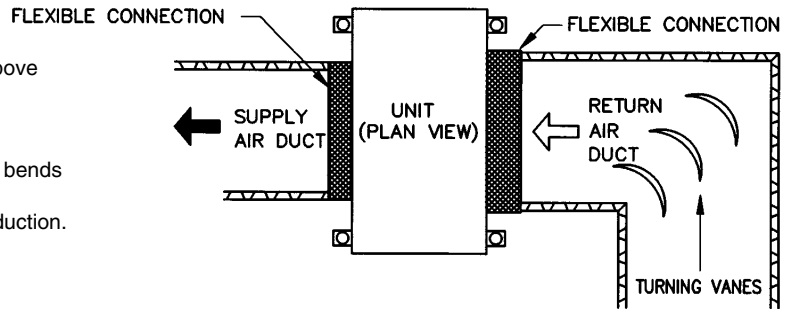

|                |                           |         |         |
|----------------|---------------------------|---------|---------|
| MODEL          | ISD                       | 310-P   | 380-P   |
| VOLTAGE IN     | V                         | 400/415 | 400/415 |
| IFM AMPS (MAX) | A                         | 2.1 x 2 | 2.5 x 2 |
| FR             | FAN RELAY                 |         |         |
| FRC            | FAN RELAY COIL            |         |         |
| IFM            | INDOOR FAN MOTOR          |         |         |
| POT            | POTENTIOMETER (MAX SPEED) |         |         |

**REFER TO WEBSITE**  
www.temperzone.biz  
FOR UP TO DATE INFORMATION

**CLIENT WIRING** -----  
Interconnections between units by client. Double insulated insulated multi-core cable.

**DE-ICE NOTE:** FOR "INDOOR" FAN OFF DURING DE-ICE CYCLE, CONNECT TO OUC'S DE-ICE N/O TERMINALS. DO NOT CONNECT TO 'DE-ICE' ON OUTDOOR UNIT'S TERMINAL BLOCK.

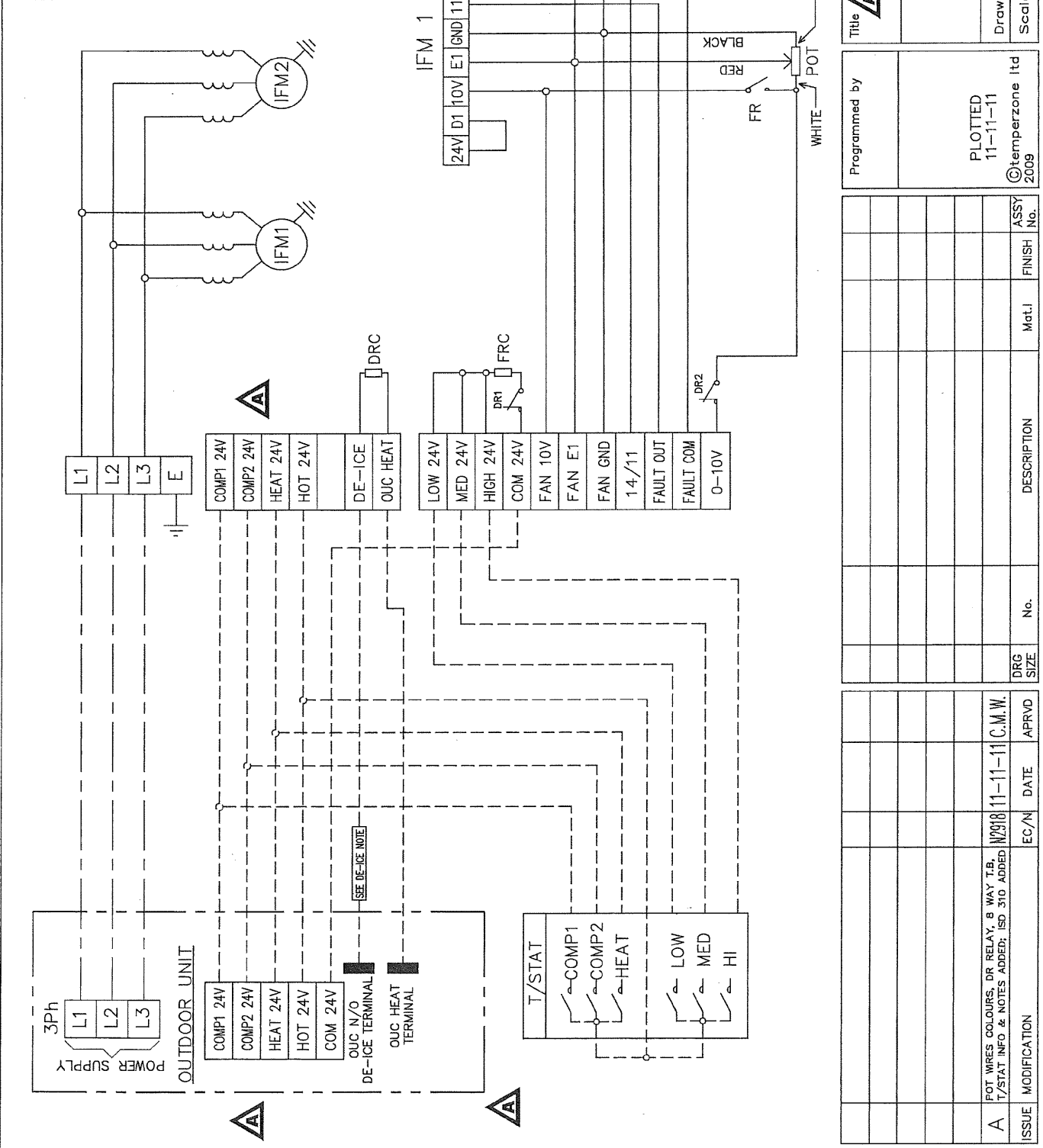

**temperzone**

Title **ISD 310 & 380KB-P WIRING SCHEMATIC**

|           |               |             |          |
|-----------|---------------|-------------|----------|
| Drawn CMW | Date 27-01-11 | Drawing No. | Revision |
| Scale     | <i>Rev</i>    | 525-504-002 | A        |

Programmed by

PLOTTED 11-11-11

©temperzone ltd 2009